



KT-WPLED60-M2-8XX-VDIM

ARCHITECTURAL 60W FULL-CUTOFF LED WALL PACK

DESCRIPTION

Architectural 60W Full-Cutoff LED Wall Pack | 120–277V Input | 4000–5000K | Medium-Size Bronze Housing | Wide Optic Lens

APPLICATION

Building Mount for exterior illumination (perimeters, pathways, loading docks, and other general security lighting requirements)

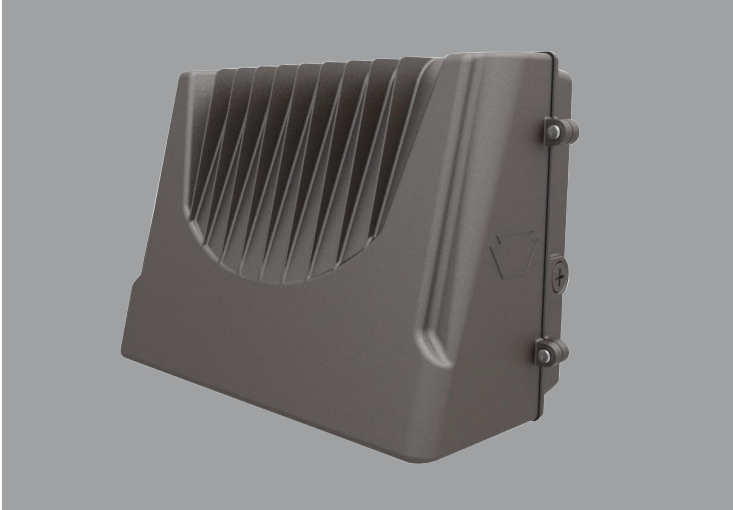

PRODUCT FEATURES

- Architectural full-cutoff design improves the appearance of building exteriors and optimizes functional light distribution
- Heavy-duty, die-cast aluminum housing features modern aesthetics while retaining (5) available 1/2" threaded conduit hubs: (1) on back and (1) on all four sides
- Powered by Keystone 0–10V dimming LED drivers
- Dark Sky friendly performance, eliminates undesirable sky glow and glare
- Features one translucent 3/4" threaded plug with anti-yellowing agent for use with photocell accessory KT-WPLED-PS-UV-KO
- Precision-crafted optical lens provides wide distribution pattern ideal for increased fixture spacing and uniformity
- Covers footprint of mid-size HID wallpacks
- Ambient operating temperature: –20°C/–4°F to 45°C/113°F
- UL listed for wet locations, IP65
- 0–10V dimming, 10% min
- Power Factor: >0.95
- THD: <20%
- LED chip lifetime: L70 >100,000 hrs @ 25°C/77°F ambient fixture temp
- Meets FCC Part 15, Part B, Class A standards for conducted and radiated emissions

ELECTRICAL SPECIFICATIONS

Catalog Number	Wattage	Lumens	Lumens Below 90°	Dimming	CCT	Efficacy	CRI	Housing Color	Input Voltage	Rated Life	Legacy Equivalent
KT-WPLED60-M2-840-VDIM	60W	7500 lm	7445 lm	0–10V	4000K	125 lm/W	>80	Bronze	120–277V	50,000 hrs	250W MH
KT-WPLED60-M2-850-VDIM		7800 lm	7745 lm		5000K	130 lm/W					



XFIT | FULL CUT OFF WALL PACK FIXTURES

KT-WPLED60-M2-8XX-VDIM ARCHITECTURAL 60W FULL-CUTOFF LED WALL PACK

PHOTOMETRIC SPECIFICATIONS

ISOCANDELA PLOT

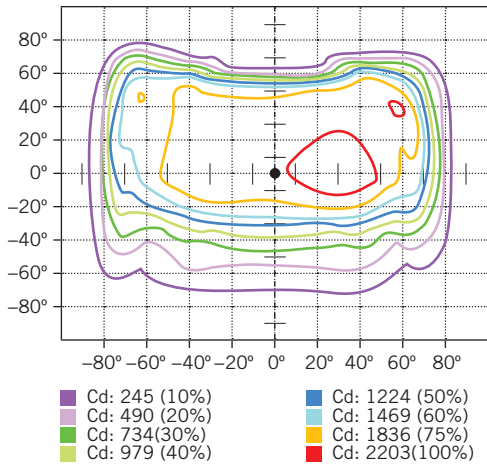

LUMINOUS INTENSITY DISTRIBUTION

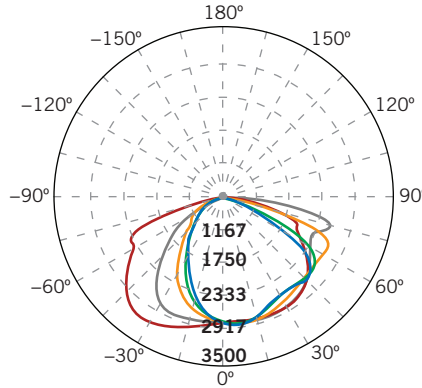

Average diffuse angle (50%): 114.2°

- 1 Blue - 0° H
- 2 Red - 90° H
- 3 Green - 22.5° H
- 4 Orange - 45° H
- 5 Grey - 67.5° H

FLUX DISTRIBUTION

Zone	Lumens	% Luminaire
Forward Light	4,722 lm	65.0%
0°-30°	907 lm	12.5%
30°-60°	2,329 lm	32.0%
60°-80°	1,327 lm	18.3%
80°-90°	159 lm	2.2%
Back Light	2,520 lm	34.6%
0°-30°	772 lm	10.6%
30°-60°	1,249 lm	17.2%
60°-80°	454 lm	6.2%
80°-90°	45 lm	0.6%
Up Light	25 lm	0.4%
90°-100°	4 lm	0.1%
100°-180°	21 lm	0.3%

MOUNTING

Side view

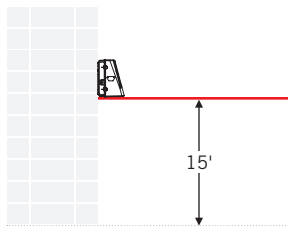

LIGHT DISTRIBUTION PATTERN

Isometric view from above; Luminaire mounted at 15'

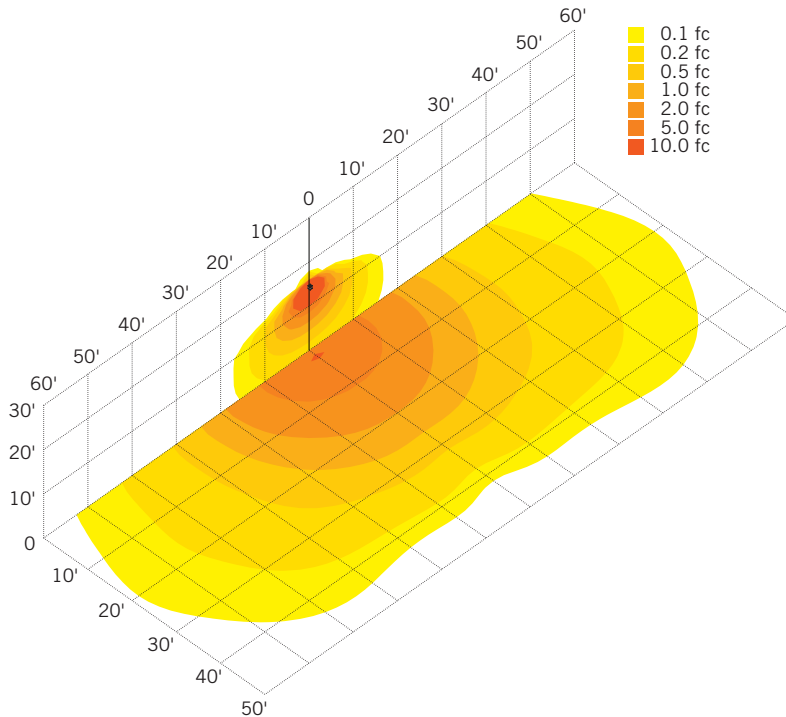



KT-WPLED60-M2-8XX-VDIM

ARCHITECTURAL 60W FULL-CUTOFF LED WALL PACK

PHYSICAL SPECIFICATIONS

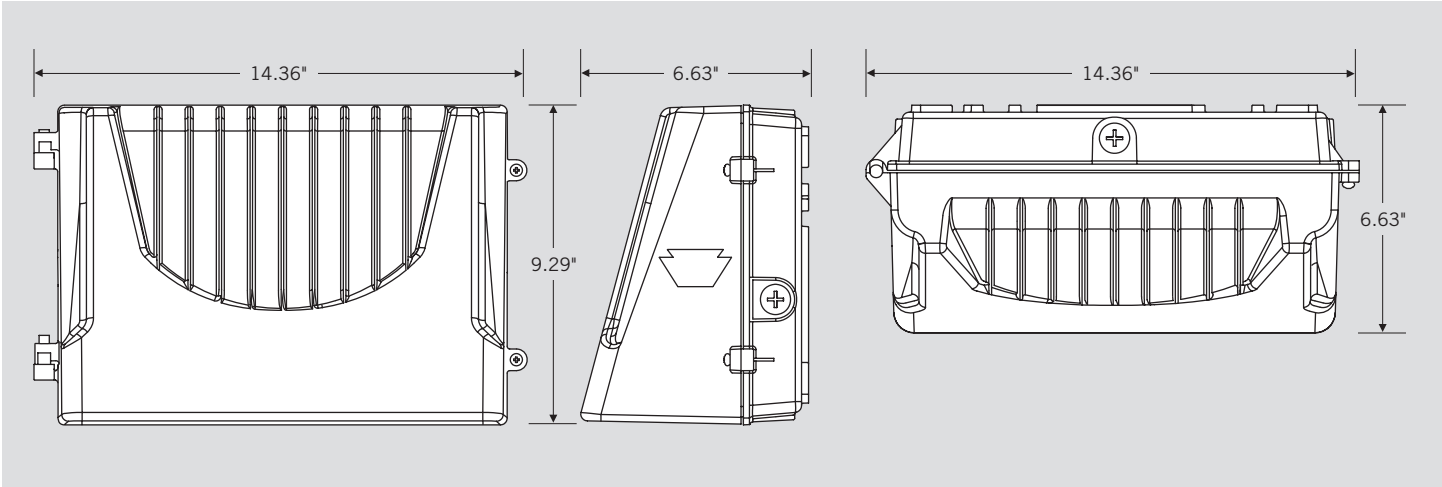

GENERAL SETUP INSTRUCTIONS

GENERAL WIRING DIAGRAM

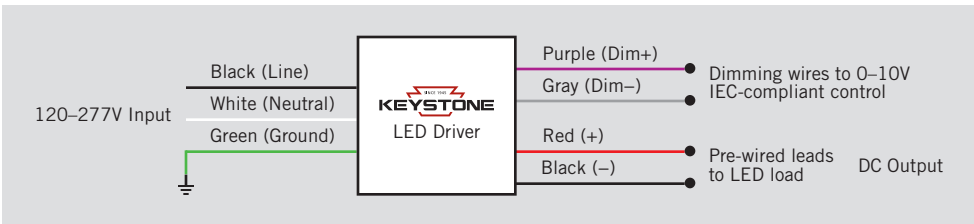

Caution: Before installing, make certain that AC power to the fixture is off.

Caution: The electrical rating of this product is 120-277V. Installer must confirm that there is 120-277V at the fixture before installation.

ACCESSORIES (SOLD SEPARATELY)

Catalog Number	Description
KTSP-10KV-C	Wallpack 10kV Surge Protector, Compact Design
KT-WPLED-PS-UV-KO	Keystone Wall Pack Button Photocell



KT-WPLED60-M2-8XX-VDIM

ARCHITECTURAL 60W FULL-CUTOFF LED WALL PACK

ORDERING INFORMATION

CATALOG NUMBER	PACK QTY.	EASY CODE	UPC
KT-WPLED60-M2-840-VDIM	1	VMR-18	843654129075
KT-WPLED60-M2-850-VDIM	1	OYW-93	843654129082

CATALOG NUMBER BREAKDOWN

KT-WPLED60-M2-8XX-VDIM /XXX

1 2 3 4 5 6 7 8 9 10

- 1 Keystone Technologies
- 2 Fixture Type
- 3 LED Lamp
- 4 Max Wattage
- 5 Size
- 6 Style
- 7 CRI
- 8 Color
- 9 Dimming
- 10 Sensor Options

2 Fixture Type

F	Flood
WP	Wallpack

5 Size

S	Small
M	Medium
L	Large

6 Style

1	Non-Cutoff
2	Full-Cutoff

7 CRI

8	>80
9	>90

8 Color

40	4000K
50	5000K

9 Dimming

VDIM	0-10V
------	-------

10 Sensor Options

/XXX	No option
/PIR	Occupancy sensor included

XFIT

FULL CUT OFF WALL PACK FIXTURES

Optimize light distribution and improve the appearance of building exteriors.



IMPROVED APPEARANCE WITH ARCHITECTURAL FULL CUTOFF DESIGN

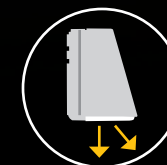

OPTIMIZE LIGHT DISTRIBUTION

MORE LIGHT DIRECTED DOWNWARD AND OUTWARD WHERE IT'S NEEDED

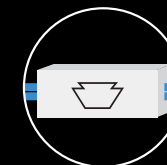

BUILT-IN 120-277V KEYSTONE LED DRIVER

PROVIDES 0-10V DIMMING & AMPLE SURGE PROTECTION FOR INCREASED VERSATILITY AND RELIABILITY



100,000 HOUR
LED LIFETIME

IP65
RATED

5 YEAR
WARRANTY

XFIT FULL CUTOFF WALL PACKS



40W FULL CUTOFF

FEATURES AND BENEFITS

- Eliminates undesirable sky glow and glare with dark sky friendly performance
- Increases control and energy efficiency with photocell accessory (available separately)
- Provides wide light distribution with advanced optical lens technology, ideal for increased fixture spacing and uniformity
- Covers the existing footprint of mid-size legacy HID fixtures with an updated design, while hiding any unsightly marks and fading
- Ensures reliable operation with a Keystone LED dimming driver
- Protected from the elements with an IP65 rating
- Adds additional energy savings with 0-10V dimming
- Features a heavy duty die cast aluminum housing in traditional bronze color

40W Full Cutoff WP:
Building exterior mounted at 15'

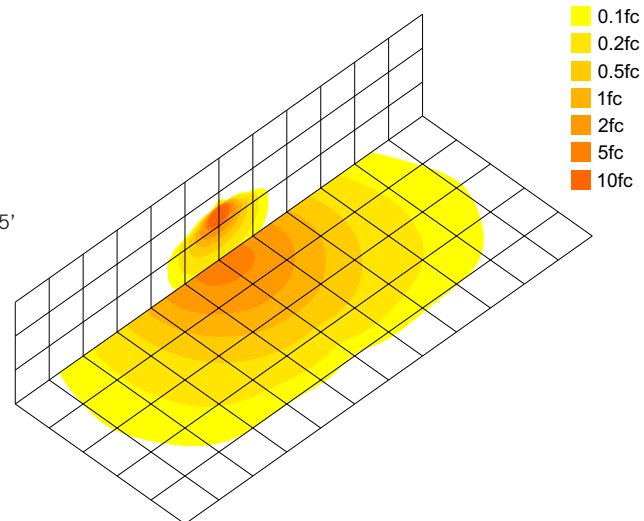

SIDE OPENING FOR EASY ACCESS

