

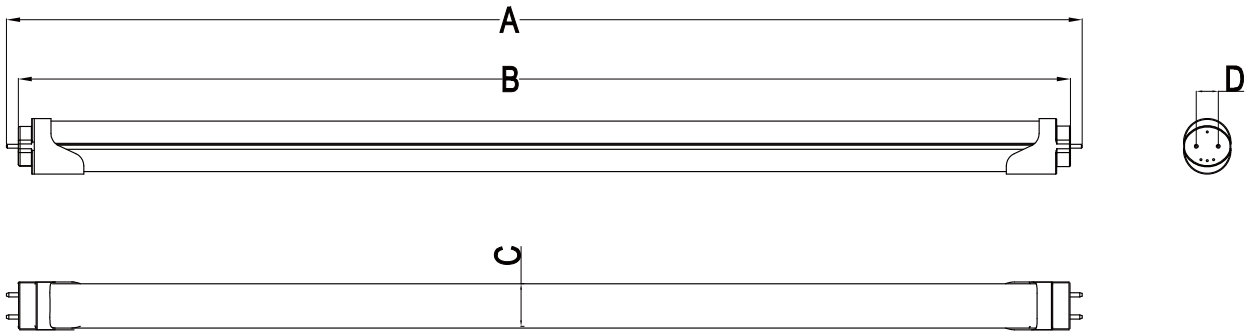

Product Features

- 1. ETL, CETL, DLC listed.
- 2. Power optional: 2ft 10W, 4ft 12W/15W/18W/22W
- 3. Lumen efficiency: 110LM/W, 130LM/W and 150LM/W
- 4. Work with ballast or without ballast.
- 5. Input voltage: 100-277VAC without ballast. 100-347VAC with ballast.
- 6. Mainly compatible with Instant start ballasts, also can work with some Rapid Start Ballasts & Programmed Start Ballasts.
- 7. Aluminum housing for excellent heat dissipation.
- 8. Bypass ballast, Double ended or single ended power optional.
- 9. Clear or frosted PC cover optional.
- 10. Five years' warranty.

Product Dimension



size	A (inch)(mm)	B (inch)(mm)	C (inch)(mm)	D (inch)(mm)
2 FT	23.70" (602mm)	23.15" (588mm)	Ø0.98" (24.8mm)	0.5" (12.7mm)
4 FT	47.72" (1212mm)	47.17" (1198mm)	Ø0.98" (24.8mm)	0.5" (12.7mm)

Specification

Mode	Size	Power	Input Voltage	Input Current	PF	Light Efficacy	Ra	CCT
T8LO-2FT-10	2FT	10W	AC100-277V	0.1A	>0.9	130lm/w	80	3000K-5000K
T8LO-4FT-12	4FT	12W	AC100-277V	0.12A	>0.9	155lm/w	80	3000K-5000K
T8LO-4FT-15	4FT	15W	AC100-277V	0.15A	>0.9	130lm/w	80	3000K-5000K
T8LO-4FT-18	4FT	18W	AC100-277V	0.18A	>0.9	130lm/w	80	3000K-5000K
T8LO-4FT-22	4FT	22W	AC100-277V	0.22A	>0.9	130lm/w	80	3000K-5000K

Testing Report

T8LO-2FT-10

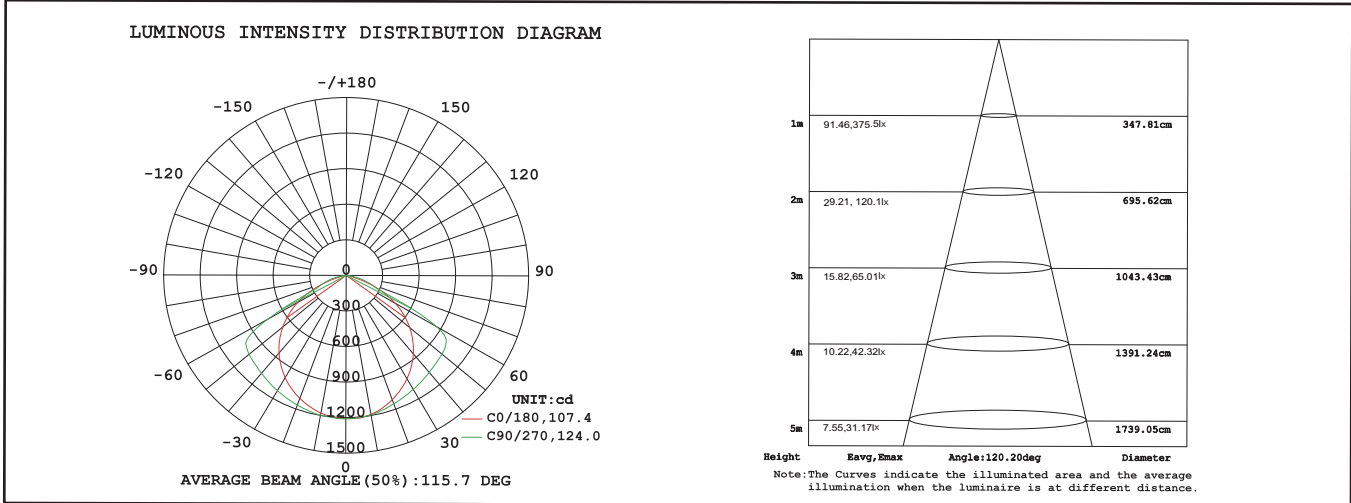

T8LO-4FT-15

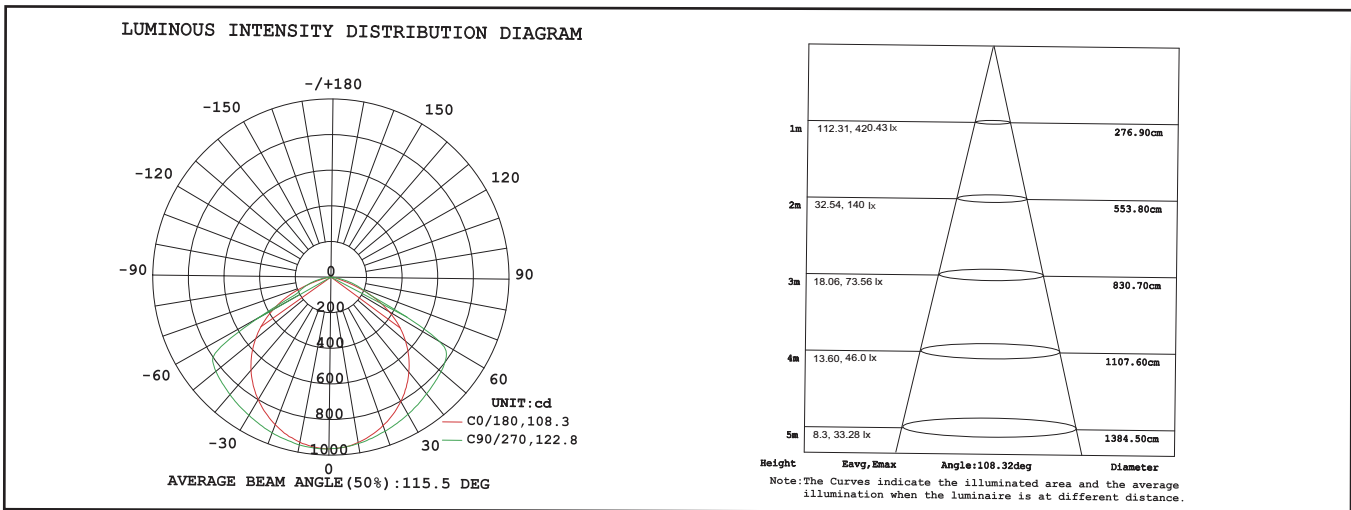

T8LO-4FT-18

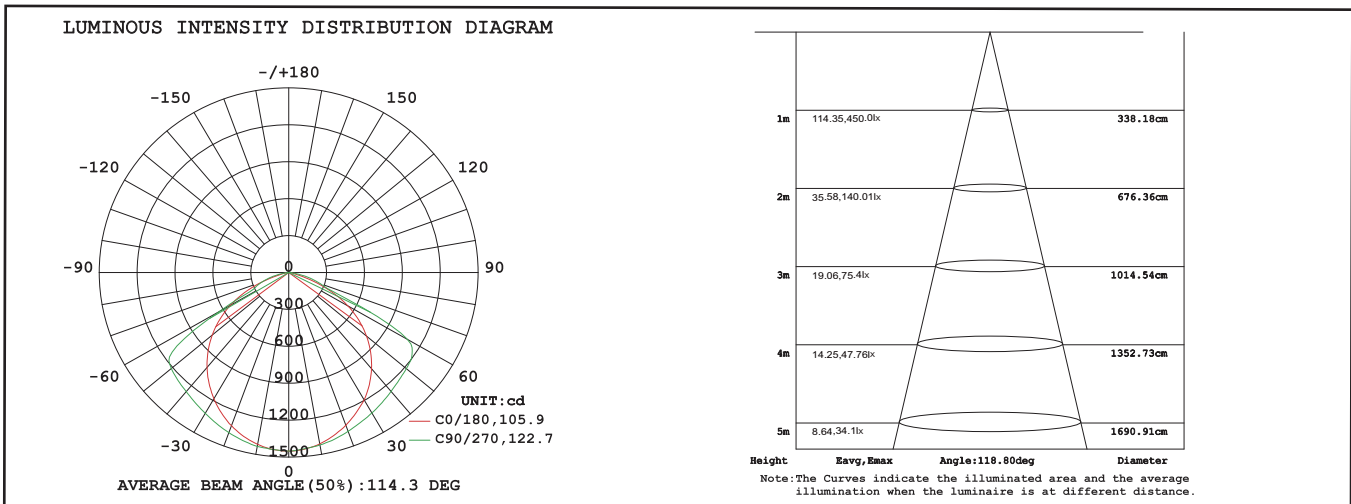

Installation

(1)Compatible with Ballast

- 1 . Turn off the electricity supply before installation.
- 2 . Make sure the circuit is as following. Please follow the illustrated steps to revise the circuit as follow

Connect with Electronic Ballast

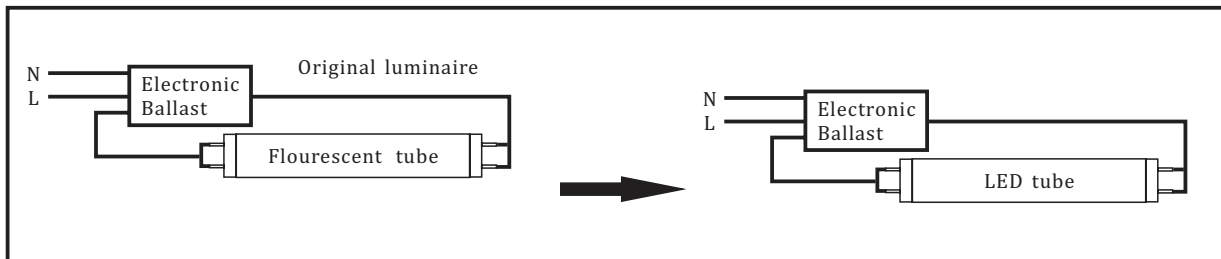

- 3 . Install the LED tubes in standard medium bi- pin lamp holder.
- 4 . After modification completes, then affix the Lamping Replacement Marking label and cautionary label, located this where visible during re-lamping on the retrofitted luminaire.

(2)Direct line voltage (AC INPUT)

- 1 . Turn off the electricity supply before installation.
- 2 . Make sure the circuit is as following. Please follow the illustrated steps to revise the circuit as follows.

Double ended power without ballast

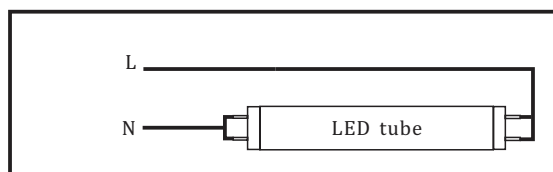

Either single ended power without ballas

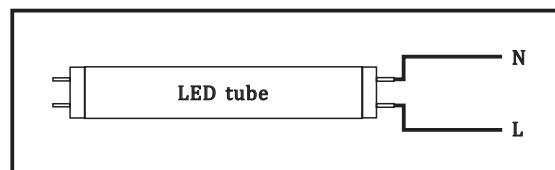
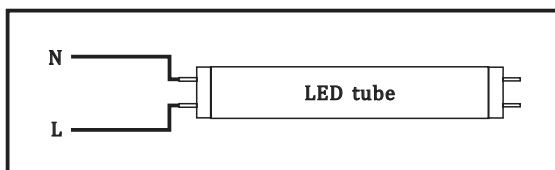

3. Install the LED tubes in standard medium bi-pin lamp holder.
4. Af ter modification completes, then affix the Lamping Replacement Marking label and cautionar y label, located this where visible during re- lamping on the retrofitted luminaire.

Packing/weight

Part NO.	Outer Carton Size (LxWxH)	Qty/Carton (pcs)	Net weight (kg)(lbs)	Gross weight (kg)(lbs)	20GP (QTY)	40HQ (QTY)
T8LO-2FT-10	(1265*155*190mm) (49.88**6.10**7.48")	50PCS	0.13kg 0.29lbs	8.5kg 19.0lbs	37100	85300
T8LO-4FT-12	(1245*155*190mm) (49.02**6.10**7.48")	25PCS	0.24kg 0.53lbs	8.0kg 18lbs	19000	43450
T8LO-4FT-15	(1245*155*190mm) (49.02**6.10**7.48")	25PCS	0.24kg 0.53lbs	8.0kg 18lbs	19000	43450
T8LO-4FT-18	(1245*155*190mm) (49.02**6.10**7.48")	25PCS	0.24kg 0.53lbs	8.0kg 18lbs	19000	43450
T8LO-4FT-22	(1245*155*190mm) (49.02**6.10**7.48")	25PCS	0.24kg 0.53lbs	8.0kg 18lbs	19000	43450

Packing

