

**TRIMAX**  
TRI-PROOF VAPOR TIGHT SERIES

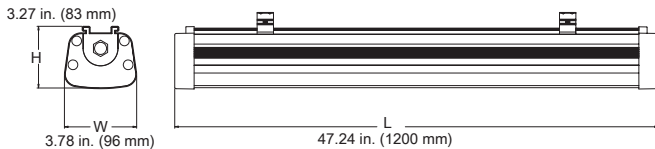

**PRODUCT DESCRIPTION:**

The TriMax Vapor Tight is a linear LED product with high efficiencies of 130 lm/W, an aluminum body to enhance heat dissipation, and flexible installation supporting either surface or suspended mounting kits. The TriMax features the unique linkability to create continuous runs of 8 ft or more. Designed with a full length polycarbonate lens, it is a waterproof, dustproof, and corrosion proof product that can be used in a wide variety of industrial and commercial environments such as warehouses, parking lots, stair wells, and many others.

**FEATURES:**

- Non-corrosive (PC) polycarbonate housing
- 120° wide beam angle
- High efficacy at 130 lm/W
- Standard fixture includes brackets for surface or suspension mounting (cables sold separately)
- IP66 rated with hermetic sealing
- 2 or more units linkable for continuous run (max 10 units)
- CRI >80
- PF >0.9
- 0-10V Dimming standard
- Optional daylight harvesting motion sensor available
- Tamper Resistant
- Motion sensor models DLC Stariwell qualified
- 50W fixtures DLC Low Bay qualified
- ETL sanitation (ANSI/NSF 2 Standards) listed for food service applications

**CONSTRUCTION:**

- One piece (PC) polycarbonate lens
- Aluminum heat sink, housing, and side caps
- Frosted lens with inside ribbing
- Universal voltage 120-277V
- Stainless steel mounting bracket clips
- Translucent end caps
- Connector kit for linkability to create 8 ft continuous runs

**WARRANTY:**

10-year standard warranty with labor allowance\* (further details available at [www.maxlite.com/warranties](http://www.maxlite.com/warranties))  
\*Warranty Limitations: Product must be rated for the application per the Product Data Sheet (PDS); operated ≤ 16 hrs; in ambient of -29F to 104F.

\*Up to \$25/unit; labor allowances of up to \$500/unit available for purchase – contact MaxLite representative for details.

MODEL SELECTION (Full list of order codes on pg. 2)				Typical order example: VT-V4830U-40					
VT	-	V	48		U	-		-	
FAMILY	-	SUB-FAMILY	SIZE	NOMINAL WATTAGE	VOLTAGE	-	CCT	OPTIONS	OPTION 2
VT= Vapor Tight	-	V= Vandal Resistant	48= 4ft	30= 30W 50= 50W	U= 120-277V	-	40= 4000K 50= 5000K	(Omit)= None *EM= Battery Backup Unit *MS= Motion Sensor	(Omit)= None L= DLC lowbay (50W only)* S= DLC Stairwell*

**NOTES:**

\*Made-to-order item. Please contact your MaxLite representative for order quantities and lead times.  
For options, product can have either EM (battery backup) or MS (motion sensor). EMMS (battery backup & motion sensor) option is not available.  
Battery backup unit provides 700 lumens for a minimum of 90 minutes.

SCAN WITH SMART DEVICE  
FOR PRODUCT VIDEO

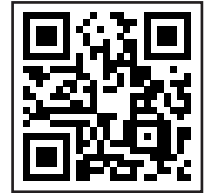

**SPECIFICATIONS:**







		VT-V4830U-40	VT-V4830U-50	VT-V4850U-40	VT-V4850U-50
ITEM	SPECIFICATION	DETAILS			
<b>GENERAL PERFORMANCE</b>	Power Consumption (W)	29.9W	30.2W	51.4W	51.0W
	Lumens Delivered (lm)	3,805 lm	3,902 lm	6,571 lm	6,683 lm
	Efficacy (lm/W)	127.3 lm/W	129.4 lm/W	127.8 lm/W	131.0 lm/W
	CRI	≥80			
	Color Temperature	4000K, 5000K			
	L70 Lifetime (hours)	50,000			
	Color Consistency	Proprietary binning for uniform color			
<b>ELECTRICAL</b>	Power Factor (277V)	0.9			
	Input Voltage	120-277V			
	Mounting	Surface Mounting, Suspended Mounting			
	Operating Temperature	-20°C to 40°C			
	Humidity	20-85% RH, non-condensing			
<b>QUALIFICATION</b>	Qualifications	DLC Premium, cETLus, FCC, ETL Sanitation Listed			
	Material Usage	RoHS compliant; no mercury			
	Environment	Indoor/Wet (IP66 rated)			
	Warranty	10 year warranty*			

**ORDERING:**

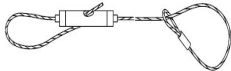
ORDER CODE	MODEL NUMBER	NOMINAL WATTAGE
14099648	VT-V4830U-40	30W
14099692	VT-V4830U-40EM	
14099693	VT-V4830U-40MS	
14099649	VT-V4830U-50	
14099694	VT-V4830U-50EM	
14099695	VT-V4830U-50MS	
14099650	VT-V4850U-40	50W
14099696	VT-V4850U-40EM	
14099697	VT-V4850U-40MS	
14099651	VT-V4850U-50	
14099698	VT-V4850U-50EM	
14099699	VT-V4850U-50MS	

SENSOR OPTION	TECHNOLOGY	DIMMING	DAYLIGHT HARVESTING	REMOTE CONTROL	QR CODE
MS	High Frequency	Bi-Level	Set Point	Yes	

For motion sensor settings and information, please visit [www.maxlite.com/controls](http://www.maxlite.com/controls)

ACCESSORY			
ORDER CODE	MODEL NUMBER	DESCRIPTION	PRODUCT IMAGE
74139	MLCHKLSV15	Cable Kit 15' Loop X Loop 1 Pair	
108133	RMHYTHRC-05	Remote for TRIMAX Motion Sensor	
14099690	VT-CONKIT	Connecting Kit (Connecting Bracket, Dimming Connecting Cable, and Power Connecting Cable)	
14099691	VT-ENDBRKT	Set of 2 End Brackets (For use with VT-CONKIT)	
14099842	VT-POWERCABLE8	Extended 8' (feet) Power Connecting Cable	
14099843	VT-DIMCABLE8	Extended 8' (feet) Dimming Connecting Cable	
14099841	VT-ENDCAP	Optional Silicone End Cap Cover (need 2 per fixture)	

**VT-CONKIT → 1 LESS THAN # FIXTURES BEING CONNECTED**

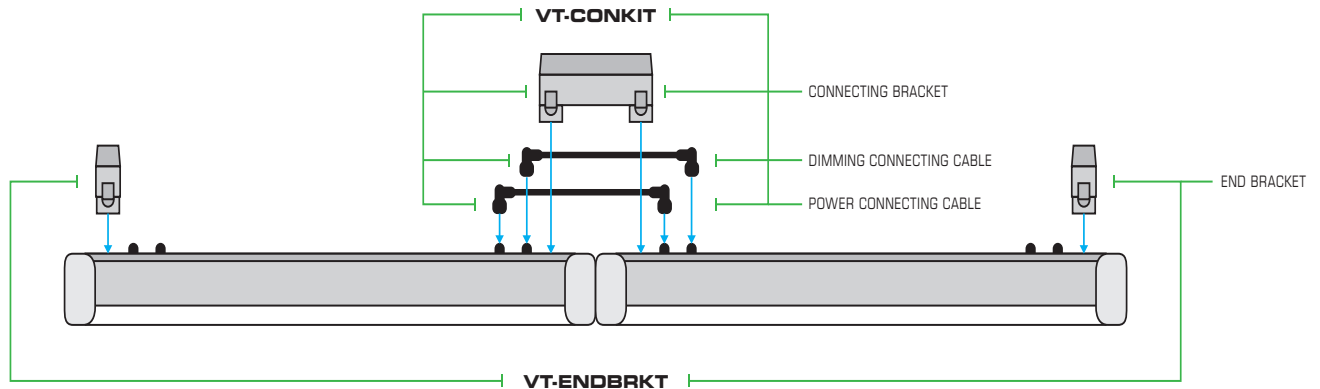

**VT-ENDBRKT → 1 PER CONNECTED RUN**