

# Series UCLL

## LED Low Profile Center Basket Recessed

Low profile, center-lensed LED fixtures ideal for shallow plenum spaces. Specification grade, direct/indirect center diffuser luminaire provides smooth and uniform ambient lighting for all commercial and industrial buildings with recessed configurations. Reflected light from matte surface adds a softened “sky light” appearance to the modern office environment. Linear ribbed lens encloses the LED array and is designed to maximize efficiency and minimize glare.

### CONSTRUCTION

Housing is die-formed and embossed 20 gauge steel. Luminaire body finish is high reflectance baked white enamel, with matte white reflectors. Wiring knockouts are provided on the back of housing and ends of fixture. Center diffuser snaps into place; no tools are required for removal. Diffuser is ribbed acrylic lens providing increased light output. Earthquake clips are standard.

### MOUNTING

Recessed inverted T-Bar ceilings. Grid mount or surface mount.



### DIMENSIONS

- 1x1 - 11.85"L x 11.85"W x 3.25"H
- 1x2 - 24"L x 12"W x 3.25"H
- 1x4 - 47.8"L x 11.7"W x 3.25"H
- 2x2 - 24"L x 24"W x 3.25"H
- 2x4 - 48"L x 24"W x 3.25"H

### FEATURES & BENEFITS

- Designed to minimize glare, producing a soft, "sky light" appearance for modern spaces
- Fifteen lumen packages/wattages across 5 fixture sizes
- Matte white reflective surfaces for soft, uniform light distribution
- Available in 4 color temperatures ranging from 3000K - 5000K
- For use in recessed inverted T-Bar or grid ceilings
- Specifically designed lens (LL) for LED array to provide enhanced light transmission while minimizing glare and LED diode shadows
- Emergency battery backup available
- CRI >80 standard, 90 optional
- L70: >50,000 Hours
- Dimming: 0-10V  
120-277V standard,  
120 ELV/TRIAC optional
- Power factor >0.90
- IC Rated for dry and damp locations
- 5 year warranty

### ORDER INFORMATION

Factory at your fingertips. Fill in the blanks to create your part number or create a custom configuration.

SERIES	LENS MATERIAL	LENGTH	WATTAGE* & LUMENS*	DRIVER
<b>UC</b> Center Basket Grid Mount	LL Linear Ribbed Lens	<b>11L<sup>1</sup></b> 11.85" x 11.85"	<b>F11W1250L</b> 11 Watts, 1250 Lumens	<b>DMV</b> 0-10V Dimming
			<b>F22W2500L</b> 22 Watts, 2500 Lumens	
<b>UCR</b> Center Basket w/Air Return	PF Perforated Basket	<b>12L<sup>1</sup></b> 12" x 24"	<b>J24W2700L</b> 24 Watts, 2700 Lumens	<b>G120</b> ELV/TRIAC Dimming at 120V only
			<b>J32W3600L</b> 32 Watts, 3600 Lumens	
<b>SSUC</b> Center Basket Sensor - On/Off		<b>14L</b> 11.7" x 47.8"	<b>J32W4300L</b> 32 Watts, 4300 Lumens	<b>D1MV</b> 0-10V Dimming (dim to 1%) (only available with SS sensor)
			<b>J48W6050L</b> 48 Watts, 6050 Lumens	
<b>SVUC</b> Center Basket Bi-Level (xx)		<b>22L</b> 24" x 24"	<b>J24W2700L</b> 24 Watts, 2700 Lumens	<b>DMV (xx)</b> 0-10V Dimming (xx) for percentage of light output when not occupied. (required for SV sensor)
			<b>J28W3150L</b> 28 Watts, 3150 Lumens	
<b>SDUC</b> Center Basket Daylight Harvesting		<b>24L</b> 24" x 48"	<b>J32W3600L</b> 32 Watts, 3600 Lumens	
			<b>J42W4300L</b> 42 Watts, 4300 Lumens	
			<b>J48W6000L</b> 48 Watts, 6000 Lumens	
			<b>J32W4350L</b> 32 Watts, 4350 Lumens	
			<b>J40W5350L</b> 40 Watts, 5350 Lumens	
			<b>J48W6100L</b> 48 Watts, 6100 Lumens	
			<b>J57W6800L</b> 57 Watts, 6800 Lumens	



Smart Sensor

COLOR/CRI**	OPTIONS
<b>30K</b> 3000K 80 CRI	<b>WP</b> 6 ft. 3 wire 18 gauge whip (non-dimming) <b>GK1</b> Single gasket (lens to door frame)
<b>35K</b> 3500K 80 CRI	<b>WP4</b> 6 ft. 4 wire 18 gauge whip (non-dimming EM) <b>GK2</b> Double gasket (lens/frame + frame to troffer)
<b>40K</b> 4000K 80 CRI	<b>WP5W</b> 6 ft. 5 wire 18 gauge whip <b>GK3</b> Triple gasket (lens/frame + frame/troffer + troffer to T-grid)
<b>50K</b> 5000K 80 CRI	<b>WP6W</b> 6 ft. 6 wire 18 gauge whip (dimming EM) <b>FIK1x4</b> 1x4 Frame-in-kit
<b>930K</b> 3000K 90 CRI	<b>EM</b> Integrated 10W Emergency battery backup (excludes 1x4, 1x2, and 1x1) <b>FIK2x2</b> 2x2 Frame-in-kit
<b>935K</b> 3500K 90 CRI	<b>EM12</b> 12W Emergency battery backup (remote only) <b>FIK2x4</b> 2x4 Frame-in-kit
<b>940K</b> 4000K 90 CRI	<b>EM20</b> 20W Emergency battery backup (remote only) <b>CP</b> Chicago Plenum
<b>950K</b> 5000K 90 CRI	

Note:

\*Programmable LED drivers allow custom configured wattages and corresponding lumens.

\*\* Consult factory for 90 CRI 5000K availability.

<sup>1</sup>Remote EM only. Not available for sensor options.

We reserve the right to change design, materials, LEDs and finish in any way that will not alter installed appearance or reduce function and performance.

### DRAWINGS & IMAGES

#### SIDE

#### 1X1

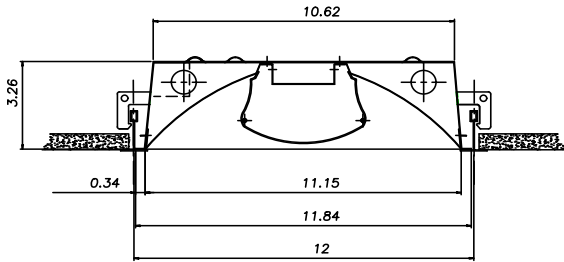

#### BACK

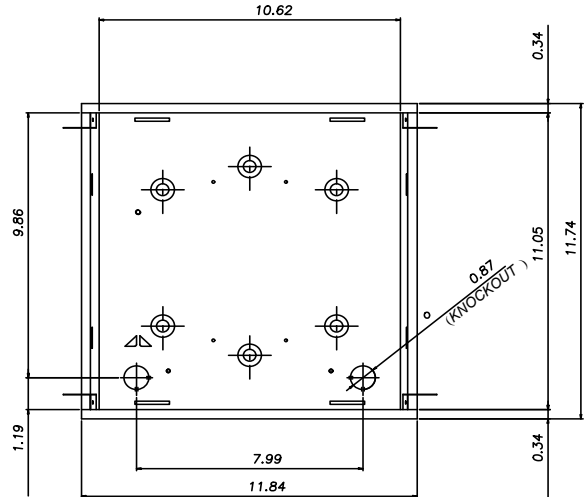

#### 1X2

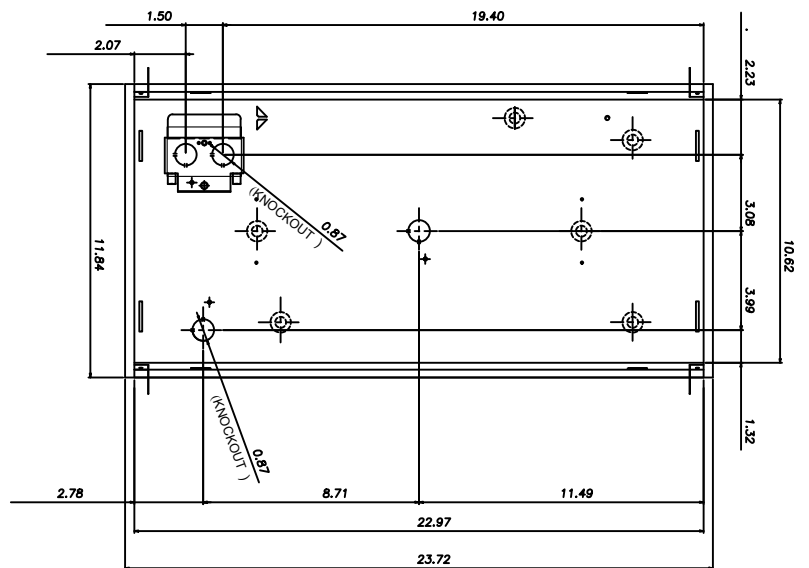
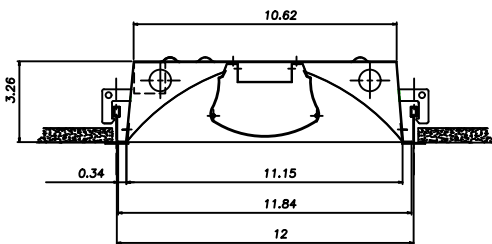

### DRAWINGS & IMAGES

#### SIDE

##### 1x4

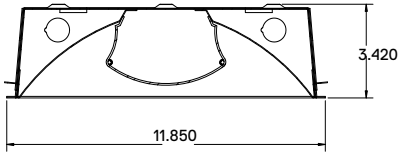

##### 2x2

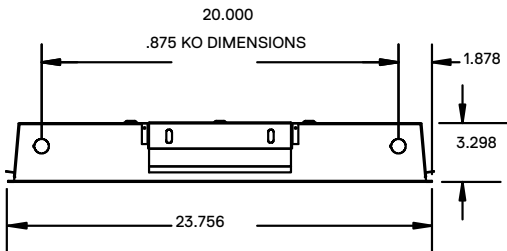

##### 2x4

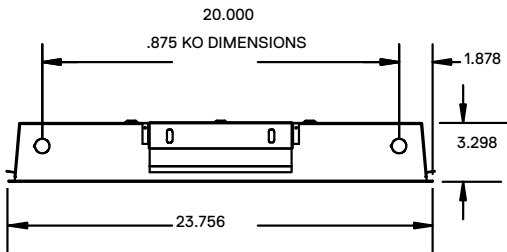

#### BACK

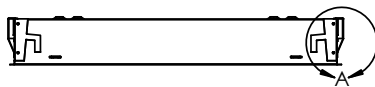
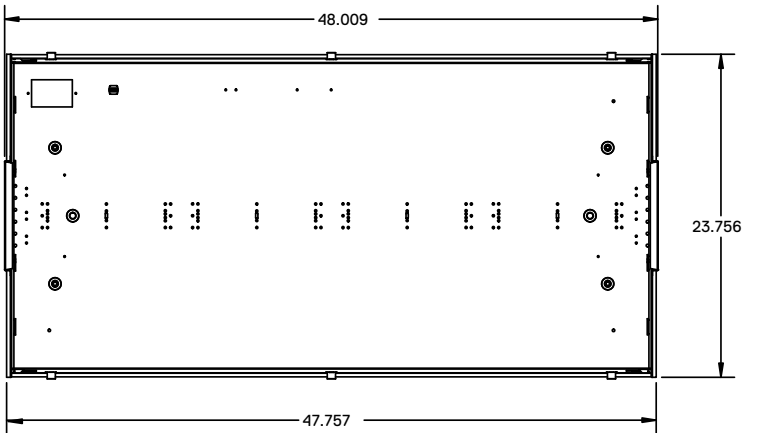
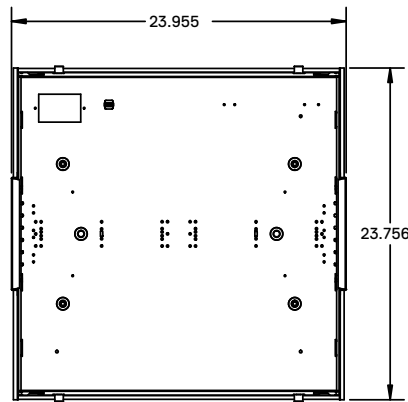
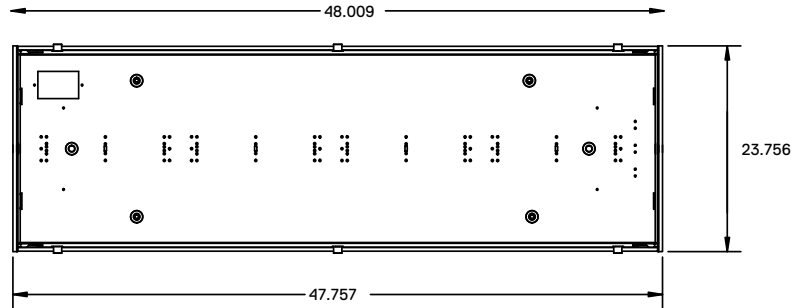

Bend out to engage earthquake hook

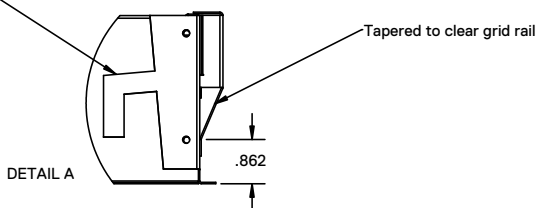

#### Replacement Lens Ordering Information

Series	Description
0UCLL1x4	Replacement lens for 1x4
0UCLL2x2	Replacement lens for 2x2
0UCLL2x4	Replacement lens for 2x4

### Photometric

#### 1x4-UCLL14LJ48W6000LDMV40K

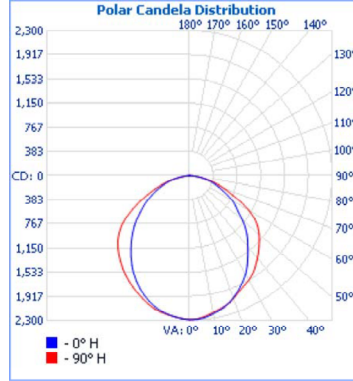
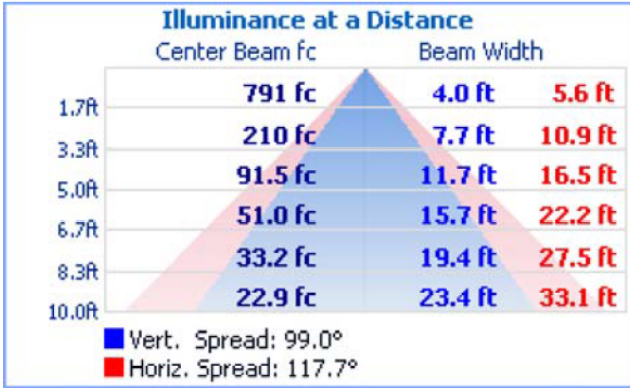

#### Zonal Lumen Summary

Zone	Lumens	%Luminaire
0-30	1,732.1	28%
0-40	2,812.3	45.4%
0-60	4,942.0	79.8%
60-90	1,247.5	20.1%
70-100	501.2	8.1%
90-120	1.6	13.9%
0-90	6,189.4	100%
90-180	1.6	0%
0-180	6,191.0	100%

#### 2x2-UCLL22LJ28W3150LDMV40K

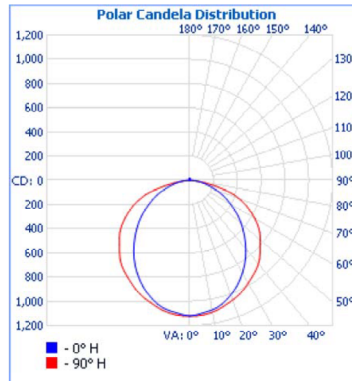
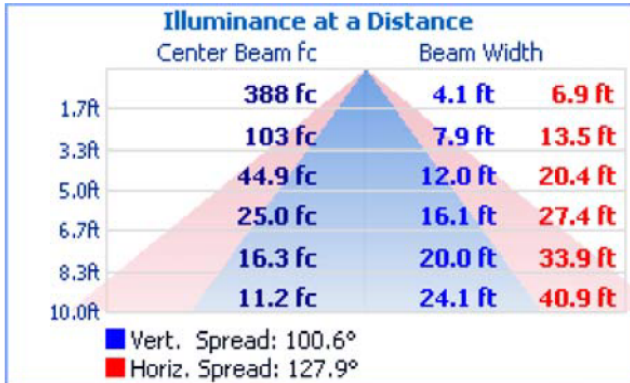

#### Zonal Lumen Summary

Zone	Lumens	%Lamp	%Luminaire
0-30	861.7	26.8%	26.3%
0-40	1,408.0	43.8%	43%
0-60	2,507.8	78%	76.7%
60-90	740.1	23%	22.6%
70-100	318.9	9.9%	9.7%
90-120	6.6	0.2%	0.2%
0-90	3,247.9	101%	99.3%
90-180	23.4	0.7%	0.7%
0-180	3,271.3	101.7%	100%

#### 2x4-UCLL24LJ57W6800LDMV40K

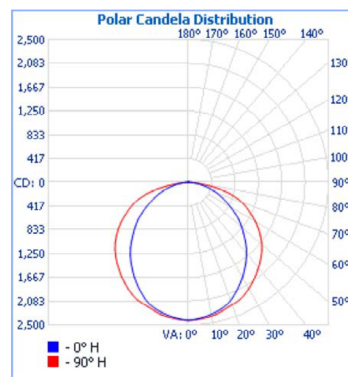
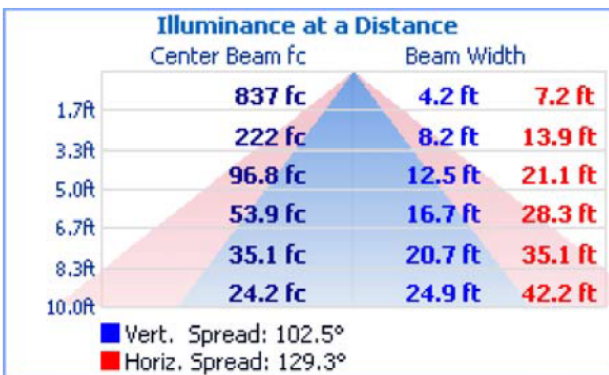

#### Zonal Lumen Summary

Zone	Lumens	%Luminaire
0-30	1,873.1	25.7%
0-40	3,074.1	42.2%
0-60	5,519.6	75.8%
60-90	1,761.3	24.2%
70-100	800.3	11%
90-120	1.6	0%
0-90	7,280.9	100%
90-180	2.5	0%
0-180	7,283.4	100%



**DLC Listed Items**

1X4 ITEM NUMBER	2X2 ITEM NUMBER	2X4 ITEM NUMBER
UCLL14LJ32W4300LDMV30K	UCLL22LF28W3500LDMV30K(WP,EM)	UCLL24LF28W2700LDMV30K
UCLL14LJ32W4300LDMV35K	UCLL22LF28W3500LDMV35K(WP,EM)	UCLL24LF32W3450LDMV30K
UCLL14LJ32W4300LDMV40K	UCLL22LF28W3500LDMV40K(WP,EM)	UCLL24LF32W3450LDMV35K
UCLL14LJ32W4300LDMV50K	UCLL22LF28W3500LDMV50K(WP,EM)	UCLL24LF32W3450LDMV40K
UCLL14LJ40W5250LDMV30K	UCLL22LF30W3600LDMV30K(WP,EM)	UCLL24LF32W3450LDMV50K
UCLL14LJ40W5250LDMV35K	UCLL22LF30W3600LDMV35K(WP,EM)	UCLL24LF48W4800LDMV30K
UCLL14LJ40W5250LDMV40K	UCLL22LF30W3600LDMV40K(WP,EM)	UCLL24LF48W4800LDMV35K
UCLL14LJ40W5250LDMV50K	UCLL22LF30W3600LDMV50K(WP,EM)	UCLL24LF48W4800LDMV40K
UCLL14LJ48W6000LDMV30K	UCLL22LJ24W2700LDMV30K	UCLL24LF48W4800LDMV50K
UCLL14LJ48W6000LDMV35K	UCLL22LJ24W2700LDMV35K	UCLL24LF57W5400LDMV30K
UCLL14LJ48W6000LDMV40K	UCLL22LJ24W2700LDMV40K	UCLL24LF60W6000LDMV30K
UCLL14LJ48W6000LDMV50K	UCLL22LJ24W2700LDMV50K	UCLL24LJ32W4350LDMV30K
UCLL14LJ57W6700LDMV30K	UCLL22LJ28W3150LDMV30K	UCLL24LJ32W4350LDMV35K
UCLL14LJ57W6700LDMV35K	UCLL22LJ28W3150LDMV35K	UCLL24LJ32W4350LDMV40K
UCLL14LJ57W6700LDMV40K	UCLL22LJ28W3150LDMV40K	UCLL24LJ32W4350LDMV50K
UCLL14LJ57W6700LDMV50K	UCLL22LJ28W3150LDMV50K	UCLL24LJ40W5350LDMV30K
UCLL22LF20W2450LDMV30K(WP,EM)	UCLL22LJ32W3600LDMV30K	UCLL24LJ40W5350LDMV35K
UCLL22LF20W2450LDMV35K(WP,EM)	UCLL22LJ32W3600LDMV35K	UCLL24LJ40W5350LDMV40K
UCLL22LF20W2450LDMV40K(WP,EM)	UCLL22LJ32W3600LDMV40K	UCLL24LJ40W5350LDMV50K
UCLL22LF20W2450LDMV50K(WP,EM)	UCLL22LJ32W3600LDMV50K	UCLL24LJ48W6100LDMV30K
UCLL22LF24W3000LDMV30K(WP,EM)	UCLL22LJ42W4300LDMV30K	UCLL24LJ48W6100LDMV35K
UCLL22LF24W3000LDMV35K(WP,EM)	UCLL22LJ42W4300LDMV35K	UCLL24LJ48W6100LDMV40K
UCLL22LF24W3000LDMV40K(WP,EM)	UCLL22LJ42W4300LDMV40K	UCLL24LJ48W6100LDMV50K
UCLL22LF24W3000LDMV50K(WP,EM)	UCLL22LJ42W4300LDMV50K	UCLL24LJ57W6800LDMV30K