

Project Name:	Type:
Part Number:	Date:

SELECTFIT G2 SERIES

SPECIFICATION FEATURES

- Mechanical** - SELECTFIT Downlight made from spinning aluminum, for maximizing passive cooling ensuring long life lasting LED. Post painted in matte white for standard fixture. This series is designed for remodel, direct mounting in the ceiling or for retrofitting existing commercial housings. Proprietary integrated driver for optimal heat protection and ensure long life of electronics components Stainless steel spring action clips allow for both easy direct installation from 1/2" to 2" ceiling thicknesses and field accessibility below the ceiling for service or replacement.
- Electrical** - Field select from three lumen outputs using SelectDrive technology. The driver also features DualDim technology, for maximum adaptability in any spaces whether it's commercial, residential or mixed. Rated for 120 to 277V, 50/60 Hz the driver is both 0-10V dimmable to 5% with low-end cut off and Forward and Reverse phase dimmable at 120V down to 10%. Please consult dimmer compatibility for additional information. Sound rating <22db.
- Optical** - Self flanged spun aluminum reflector, painted with high reflection matte white. Clear or wall wash trim insert available for field installation. High resistance and non-yellowing polycarbonate lenses for optimal low glare light diffusion. Featuring SelectKelvin technology with field selectable CCTs 2700/3000/3500/4000/5000K. LED binning within 3 SDCM maximum. Offered in minimum 90 CRI. 80° nominal optical wide beam angle standard, medium optic (60-70°, 1.0 S/MH nominal) available as field changeable accessory.
- Thermal** - Die cast heat sink maximizes passive thermal management and achieves a L70 calculated lifetime of 100,000 hours, at 25°C, meeting TM-21-19 requirements. Ambient temperature rated from -40°F to 113°F (-40°C to 45°C). IC installation for IC rated parts limited to +35°C (95.0°F) ambient temperature.
- Compliance and Warranty** - ETL Classified and Listed for wet location from the bottom once properly installed. Certified air-tight per ASTM 283-04. Complies with FCC 47CFR Part 15B consumer limits for EMI/RFI emissions at 120V. Suitable for use in clothes closets when installed in accordance with the NEC 410.16 spacing requirements. 4", 6" and 8" are certified IC for direct contact with insulation. 6" HO, 8" HO and 9.5" are not IC rated. Can be used for State of California Title 24 high efficacy LED compliance under JA8. 5 Year Warranty for complete fixture. Optional 10 Year Extended Warranty available, subject to same terms, conditions and installation requirements as standard 5 Year Warranty.

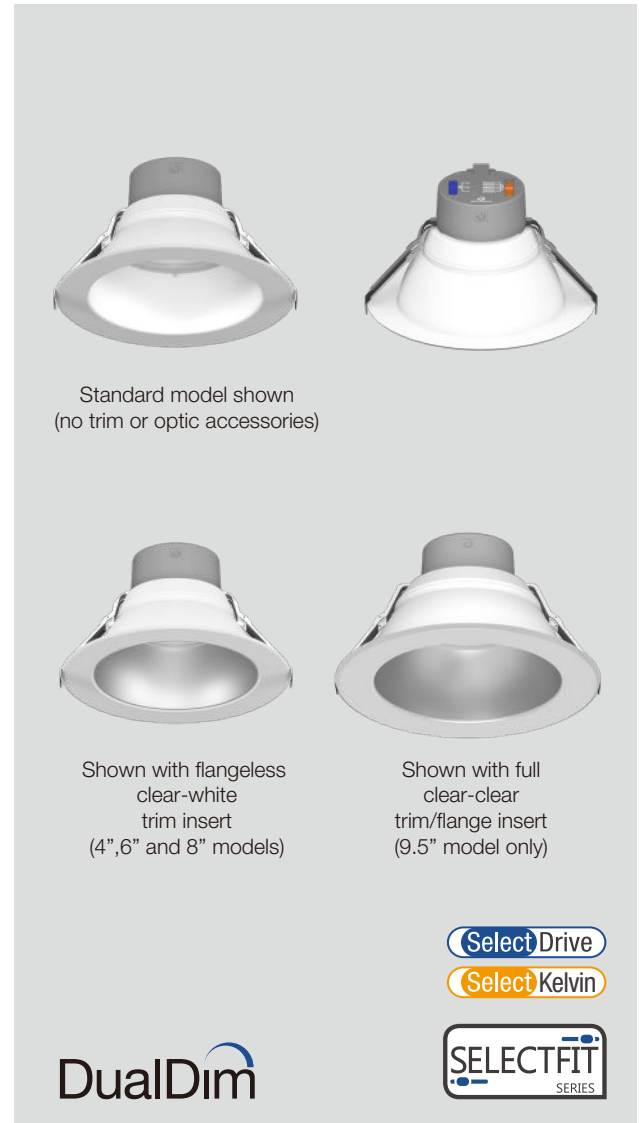

021523



BENEFITS

- DualDim technology provides the easiest remodeling, direct mount or retrofit installation dimming compatibility
- SelectKelvin technology to choose from five color temperatures ranging from 2700K to 5000K
- SelectDrive technology allow to select from 3 lumen outputs
- Install virtually anywhere with Wet Location, IC rated models and Air-tight ratings
- Long lifetime in high ambient temperature range installation

APPLICATIONS

- Commercial
- Retail
- Hospitality
- Education
- Outdoor under covered ceilings



SELECTFIT G2 SERIES

ORDERING EXAMPLE

SLFT(size+lumen output) _____ (CRI+CCT) _____ (Driver) _____

SLFT6/9CCT5S/DUALDIM

Model Serie	Size	CRI	CCT	Driver
<input type="checkbox"/> SLFT SELECTFIT Downlight	<input type="checkbox"/> 4 4" 900/750/600lm	<input type="checkbox"/> 9 CRI 90+	<input type="checkbox"/> CCT5S Selectable CCT 2700 / 3000 / 3500 / 4000 / 5000K	<input type="checkbox"/> DUALDIM 120V-277V, 50/60Hz. 0-10V or Forward/Reverse phase dimming at 120V only.
	<input type="checkbox"/> 6 6" 1650/1300/1000lm			
	<input type="checkbox"/> 6HO 6" 2900/2300/1750lm			
	<input type="checkbox"/> 8 8" 2100/1600/1200lm			
	<input type="checkbox"/> 8HO 8" 4200/3600/2900lm			
	<input type="checkbox"/> 9.5 9.5" 4000/3200/2400lm			

DIMENSIONS

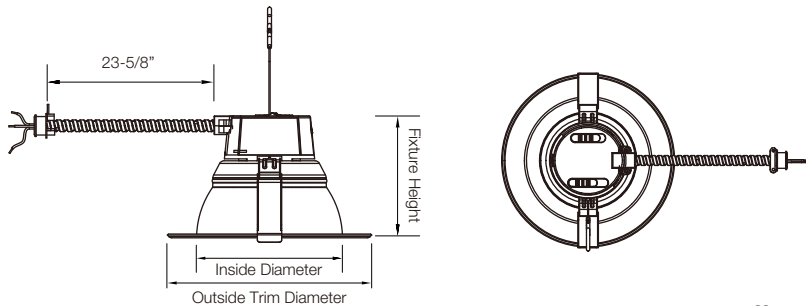

Fixture	Inside Diameter	Outside Trim Diameter	Fixture Height
SLFT4	4-1/8"	5-15/16"	4-1/8"
SLFT6	6-1/16"	8-1/4"	4-15/16"
SLFT6HO	6-1/16"	8-1/4"	4-15/16"
SLFT8	7-5/8"	10-1/4"	5-11/16"
SLFT8HO	7-5/8"	10-1/4"	5-11/16"
SLFT9.5	8-5/8"	11-3/8"	6-3/16"

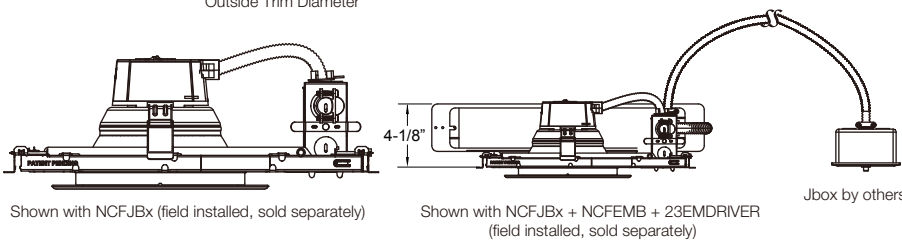

Remodel /Retrofit/Direct Mount Ceiling Cutout		
Type	Minimum	Maximum
SLFT4	4-1/8"	5-1/8"
SLFT6	6-1/8"	7-1/2"
SLFT6HO	6-1/8"	7-1/2"
SLFT8	7-11/16"	9-7/16"
SLFT8HO	7-11/16"	9-7/16"
SLFT9.5	8-11/16"	10-9/16"

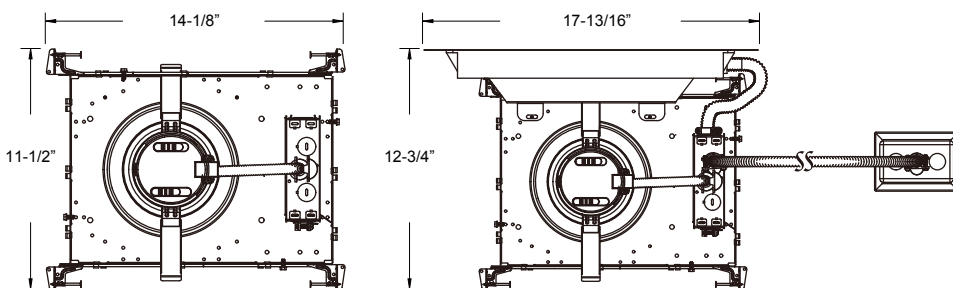



SELECTFIT G2 SERIES

TECHNICAL INFORMATION

Type	Dimming	Input Voltage	Input Frequency	Input Current	Input Power	THD Power	Power Factor	Flicker Index	Sound Rating
SLFT4/9CCT5S/DUALDIM	0-10V and ELV/TRIAC	120-277V	50-60Hz	0.095A	10/8/7W	<20%	>0.9	<30%	<22db
SLFT6/9CCT5S/DUALDIM				0.15A	17/13.5/10W				
SLFT6HO/9CCT5S/DUALDIM				0.285A	30/24/18W				
SLFT8/9CCT5S/DUALDIM				0.19A	20/16/12W				
SLFT8HO/9CCT5S/DUALDIM				0.38A	42.5/37/30W				
SLFT9.5/9CCT5S/DUALDIM				0.38A	40/32/24W				

NOMINAL PERFORMANCE

Product	Wattage (W)	2700KCCT / CRI92		3000KCCT / CRI92		3500KCCT / CRI92		4000KCCT / CRI92		5000KCCT / CRI92	
		Lumens (lm)	Efficacy (LPW)	Lumens (lm)	Efficacy (LPW)	Lumens (lm)	Efficacy (LPW)	Lumens (lm)	Efficacy (LPW)	Lumens (lm)	Efficacy (LPW)
SLFT4/9CCT5S/DUALDIM	7	600	86	610	87	630	90	630	90	630	90
	8	700	88	710	89	730	91	730	91	730	91
	10	800	80	840	84	960	96	880	89	880	88
SLFT6/9CCT5S/DUALDIM	10	900	90	930	93	970	97	970	97	970	97
	13.5	1,200	89	1,250	93	1,300	96	1,300	96	1,300	96
	17	1,500	88	1,580	93	2,030	119	1,650	97	1,650	97
SLFT6HO/9CCT5S/DUALDIM	18	1,650	92	1,700	94	1,750	97	1,750	97	1,750	97
	24	2,000	83	2,100	88	2,320	97	2,320	97	2,320	97
	30	2,600	88	2,800	93	3,560	119	2,900	97	2,900	97
SLFT8/9CCT5S/DUALDIM	12	1,000	83	1,100	92	1,200	97	1,200	97	1,200	97
	16	1,400	88	1,500	94	1,600	97	1,600	97	1,600	97
	20	1,850	99	1,950	98	2,320	116	2,100	97	2,100	97
SLFT8HO/9CCT5S/DUALDIM	30	2,650	88	2,750	92	2,900	97	2,900	97	2,900	97
	37	3,250	88	3,350	91	3,580	97	3,580	97	3,580	97
	42.5	3,800	89	3,800	89	4,790	113	4,200	97	4,200	97
SLFT9.5/9CCT5S/DUALDIM	24	2,100	88	2,200	92	2,400	100	2,400	100	2,400	100
	32	2,900	91	3,000	94	3,200	100	3,200	100	3,200	100
	40	3,600	90	3,700	93	4,950	124	4,000	100	4,000	100

ORDERING INFORMATION

Product	Model	Shipping Carton		
		Case Qty	Case Dimensions (LxWxH)	Case Weight
37030	SLFT4/9CCT5S/DUALDIM	6pcs	13-1/16" x 6-5/8" x 15-3/16"	8.16lb
37031	SLFT6/9CCT5S/DUALDIM	6pcs	17-7/8" x 9-1/16" x 17-1/16"	11.9lb
37032	SLFT6HO/9CCT5S/DUALDIM	6pcs	17-7/8" x 9-1/16" x 17-1/16"	11.9lb
37033	SLFT8/9CCT5S/DUALDIM	6pcs	21-13/16" x 11" x 20-13/16"	16.98lb
37034	SLFT8HO/9CCT5S/DUALDIM	6pcs	21-13/16" x 11" x 20-13/16"	16.98lb
37035	SLFT9.5/9CCT5S/DUALDIM	6pcs	24" x 12-3/16" x 21-3/4"	17.2lb

CERTIFICATION INFORMATION

Product	Model	ES ID#
37030	SLFT4/9CCT5S/DUALDIM [Blank; +SLFT4/MD/OPTIC]	2407835
37031	SLFT6/9CCT5S/DUALDIM [Blank; +SLFT6/MD/OPTIC]	2407836
37032	SLFT6HO/9CCT5S/DUALDIM [Blank; +SLFT6/MD/OPTIC]	2407831
37033	SLFT8/9CCT5S/DUALDIM [Blank; +SLFT8/MD/OPTIC]	2407837
37034	SLFT8HO/9CCT5S/DUALDIM [Blank; +SLFT8/MD/OPTIC]	2407832
37035	SLFT9.5/9CCT5S/DUALDIM	2407833



SELECTFIT G2 SERIES

ACCESSORY ORDERING INFORMATION				
Product	Model	Description	Pictures	Dimensions
37041	SLFT4/CL/TRIM	SELECTFIT G2 4" Field Installable flangeless clear trim insert (Clips inside the reflector for Clear + White flange finish)		
37042	SLFT6/CL/TRIM	SELECTFIT G2 6" Field Installable flangeless clear trim insert (Clips inside the reflector for Clear + White flange finish)		
37043	SLFT8/CL/TRIM	SELECTFIT G2 8" Field Installable flangeless clear trim insert (Clips inside the reflector for Clear + White flange finish)		
35160	SLFT/TRIM9.5/CC	Field installable 9.5" Clear Trim and flange Insert (Attaches on the flange for Clear + Clear flange finish)		
37036	SLFT4/MD/OPTIC	SELECTFIT G2 4" Field changeable Medium Optic (need to remove and replace the standard optic)		
37037	SLFT6/MD/OPTIC	SELECTFIT G2 6" Field changeable Medium Optic (need to remove and replace the standard optic)		
37038	SLFT8/MD/OPTIC	SELECTFIT G2 8" Field changeable Medium Optic (need to remove and replace the standard optic)		
37039	SLFT4/WW/ACC	SELECTFIT G2 4" Field installable Wall Wash white insert (wall wash insert can not be combined with Trim insert)		
37040	SLFT6/WW/ACC	SELECTFIT G2 6" Field installable Wall Wash white insert (wall wash insert can not be combined with Trim insert)		
35121	NCFJB4	4" New Construction Frame for T-Grid ceilings and stud/joist mounting		
35122	NCFJB6	6" New Construction Frame for T-Grid ceilings and stud/joist mounting		
35123	NCFJB8	8" New Construction Frame for T-Grid ceilings and stud/joist mounting		



SELECTFIT G2 SERIES

ACCESSORY ORDERING INFORMATION				
Product	Model	Description	Pictures	Dimensions
35124	NCFJB9.5	9.5" New Construction Frame for T-Grid ceilings and stud/joist mounting		
35126	NCFBFB	Field Installable Butterfly Brackets For New Construction Frame		
35125	NCFEMB	Field Installable Brackets For emergency Driver or Inverter with New Construction Frame		
98502	NCPLATE468	4", 6" and 8" New Construction Plate for Stud/Joist Mounting		
98501	NCPLATE/T4689	New Construction or Remodel Plate for T-Grid Ceilings		
98569	GOOFRING4	4" Goof Ring - Outer Diameter 8-1/8"		
98568	GOOFRING6	6" Goof Ring - Outer Diameter 10-1/2"		
98567	GOOFRING8	8" Goof Ring - Outer Diameter 12-1/2"		
98566	GOOFRING9.5	9.5" Goof Ring - Outer Diameter 14-3/16"		
98003	23EMDRIVER	California Title 20 Compliant 23W Emergency LED Driver (Field Installation)		
FHUPS1-UNV-25L-SD	FHUPS1-UNV-25L-SD	25W Emergency Micro Inverter for field installation to use with 0-10V Driver options. 100-277VAC (up to 150W with use of 0-10V dimming). CEC Compliant		

SELECTFIT G2 SERIES

PHOTOMETRY

SLFT4/9CCT5S/DUALDIM (at 3500K)

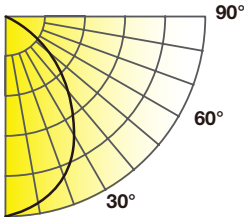

Lumens: 965 lm
 CBCP: 531 cd
 Power: 10 W
 Efficacy: 98 lm/W
 CRI: 92
 Spacing Criteria: 1.1
 Beam Angle: 81°

Candlepower Distribution		Initial Footcandles			Zonal Lumen Summary		
Angle (°)	Average (cd)	Height (ft)	Fc	Diameter (ft)	Zone	Lumens	%Fixt
10	517	10	8	17	0-10	50	5
20	471	20	2	34	0-20	190	20
30	379	30	1	51	0-30	386	40
40	269	40	0	68	0-60	866	90
50	171	50	0	85	0-90	965	100
60	89	60	0	102			
70	44	70	0	119			
80	14	80	0	135			
90	0	90	0	152			

SLFT4/9CCT5S/DUALDIM + SLFT4/MD/OPTIC (at 3500K)

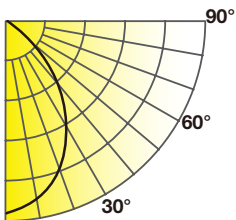

Lumens: 998 lm
 CBCP: 679 cd
 Power: 10 W
 Efficacy: 102 lm/W
 CRI: 92
 Spacing Criteria: 1.0
 Beam Angle: 70°

Candlepower Distribution		Initial Footcandles			Zonal Lumen Summary		
Angle (°)	Average (cd)	Height (ft)	Fc	Diameter (ft)	Zone	Lumens	%Fixt
10	636	10	9	14	0-10	63	6
20	539	20	2	28	0-20	231	23
30	403	30	1	42	0-30	450	45
40	268	40	1	56	0-60	922	92
50	154	50	0	70	0-90	998	100
60	78	60	0	84			
70	31	70	0	97			
80	11	80	0	111			
90	0	90	0	125			

SLFT4/9CCT5S/DUALDIM + SLFT4/WW/ACC (at 3500K)

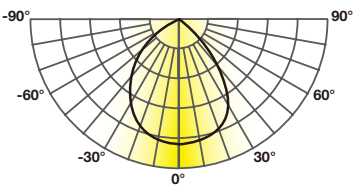

Lumens: 568 lm
 CBCP: 338 cd
 Power: 10 W
 Efficacy: 57 lm/W
 CRI: 92
 Spacing Criteria: 0.9
 Beam Angle: 75°

Candlepower Distribution		Initial Footcandles			Zonal Lumen Summary		
Angle (°)	Average (cd)	Height (ft)	Fc	Diameter (ft)	Zone	Lumens	%Fixt
10	272	10	4	15	0-10	26	5
20	252	20	1	31	0-20	101	18
30	216	30	0	46	0-30	208	37
40	165	40	0	62	0-60	498	88
50	113	50	0	77	0-90	568	100
60	67	60	0	93			
70	33	70	0	108			
80	11	80	0	124			
90	0	90	0	139			

SELECTFIT G2 SERIES

PHOTOMETRY

SLFT6/9CCT5S/DUALDIM (at 3500K)

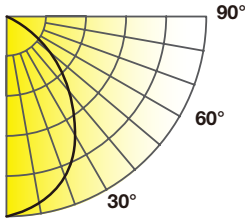

Lumens: 2,031 lm
 CBCP: 1,087 cd
 Power: 18 W
 Efficacy: 122 lm/W
 CRI: 92
 Spacing Criteria: 1.1
 Beam Angle: 84°

Candlepower Distribution		Initial Footcandles			Zonal Lumen Summary		
Angle (°)	Average (cd)	Height (ft)	Fc	Diameter (ft)	Zone	Lumens	%Fixt
10	1,058	10	16	18	0-10	102	5
20	973	20	4	36	0-20	390	19
30	815	30	2	54	0-30	804	40
40	588	40	1	71	0-60	1,831	90
50	351	50	1	89	0-90	2,028	100
60	169	60	0	107			
70	85	70	0	125			
80	35	80	0	143			
90	0	90	0	161			

SLFT6/9CCT5S/DUALDIM + SLFT6/MD/OPTIC (at 3500K)

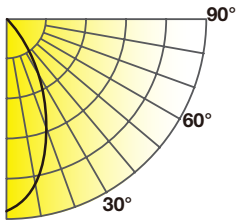

Lumens: 2,081 lm
 CBCP: 1,793 cd
 Power: 18 W
 Efficacy: 125 lm/W
 CRI: 92
 Spacing Criteria: 0.8
 Beam Angle: 60°

Candlepower Distribution		Initial Footcandles			Zonal Lumen Summary		
Angle (°)	Average (cd)	Height (ft)	Fc	Diameter (ft)	Zone	Lumens	%Fixt
10	1,595	10	24	12	0-10	162	8
20	1,236	20	6	23	0-20	557	27
30	895	30	3	35	0-30	1,047	50
40	557	40	1	46	0-60	1,954	94
50	254	50	1	58	0-90	2,078	100
60	109	60	1	69			
70	53	70	0	81			
80	23	80	0	92			
90	0	90	0	104			

SLFT6/9CCT5S/DUALDIM + SLFT6/WW/ACC (at 3500K)

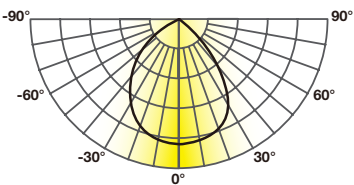

Lumens: 1,309 lm
 CBCP: 748 cd
 Power: 18 W
 Efficacy: 79 lm/W
 CRI: 92
 Spacing Criteria: 1.0
 Beam Angle: 77°

Candlepower Distribution		Initial Footcandles			Zonal Lumen Summary		
Angle (°)	Average (cd)	Height (ft)	Fc	Diameter (ft)	Zone	Lumens	%Fixt
10	598	10	9	16	0-10	58	4
20	550	20	2	32	0-20	222	17
30	491	30	1	48	0-30	464	36
40	381	40	1	64	0-60	1,137	87
50	259	50	0	80	0-90	1,308	100
60	154	60	0	96			
70	83	70	0	112			
80	30	80	0	128			
90	0	90	0	144			

SELECTFIT G2 SERIES

PHOTOMETRY

SLFT6HO/9CCT5S/DUALDIM (at 3500K)

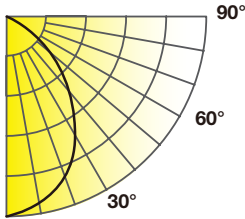

Lumens: 3,569 lm
 CBCP: 1,911 cd
 Power: 30 W
 Efficacy: 124 lm/W
 CRI: 92
 Spacing Criteria: 1.1
 Beam Angle: 83°

Candlepower Distribution		Initial Footcandles			Zonal Lumen Summary		
Angle (°)	Average (cd)	Height (ft)	Fc	Diameter (ft)	Zone	Lumens	%Fixt
10	1,858	10	28	18	0-10	180	5
20	1,705	20	7	36	0-20	685	19
30	1,416	30	3	53	0-30	1,409	40
40	1,014	40	2	71	0-60	3,208	90
50	615	50	1	89	0-90	3,563	100
60	299	60	1	107			
70	154	70	1	124			
80	63	80	0	142			
90	0	90	0	160			

SLFT6HO/9CCT5S/DUALDIM + SLFT6/MD/OPTIC (at 3500K)

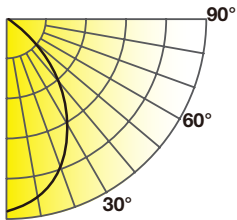

Lumens: 3,584 lm
 CBCP: 2,811 cd
 Power: 30 W
 Efficacy: 125 lm/W
 CRI: 92
 Spacing Criteria: 0.9
 Beam Angle: 64°

Candlepower Distribution		Initial Footcandles			Zonal Lumen Summary		
Angle (°)	Average (cd)	Height (ft)	Fc	Diameter (ft)	Zone	Lumens	%Fixt
10	2,581	10	38	13	0-10	258	7
20	2,056	20	10	25	0-20	911	25
30	1,517	30	4	38	0-30	1,735	48
40	980	40	2	50	0-60	3,348	93
50	481	50	2	63	0-90	3,579	100
60	204	60	1	75			
70	95	70	1	88			
80	42	80	1	100			
90	0	90	0	113			

SLFT6HO/9CCT5S/DUALDIM + SLFT6/WW/ACC (at 3500K)

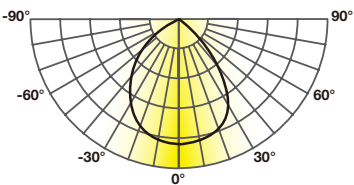

Lumens: 2,289 lm
 CBCP: 1,292 cd
 Power: 30 W
 Efficacy: 80 lm/W
 CRI: 92
 Spacing Criteria: 1.0
 Beam Angle: 78°

Candlepower Distribution		Initial Footcandles			Zonal Lumen Summary		
Angle (°)	Average (cd)	Height (ft)	Fc	Diameter (ft)	Zone	Lumens	%Fixt
10	1,037	10	15	16	0-10	101	4
20	956	20	4	32	0-20	385	17
30	850	30	2	48	0-30	805	35
40	663	40	1	64	0-60	1,982	87
50	448	50	1	81	0-90	2,287	100
60	269	60	0	97			
70	147	70	0	113			
80	52	80	0	129			
90	0	90	0	145			

SELECTFIT G2 SERIES

PHOTOMETRY

SLFT8/9CCT5S/DUALDIM (at 3500K)

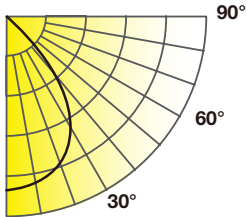

Lumens: 2,325 lm
 CBCP: 1,264 cd
 Power: 20 W
 Efficacy: 120 lm/W
 CRI: 92
 Spacing Criteria: 1.1
 Beam Angle: 84°

Candlepower Distribution		Initial Footcandles			Zonal Lumen Summary		
Angle (°)	Average (cd)	Height (ft)	Fc	Diameter (ft)	Zone	Lumens	%Fixt
10	1,230	10	18	18	0-10	119	5
20	1,126	20	5	36	0-20	453	20
30	960	30	2	54	0-30	936	40
40	687	40	1	72	0-60	2,114	91
50	395	50	1	89	0-90	2,321	100
60	179	60	1	107			
70	86	70	0	125			
80	41	80	0	143			
90	0	90	0	161			

SLFT8/9CCT5S/DUALDIM + SLFT8/MD/OPTIC (at 3500K)

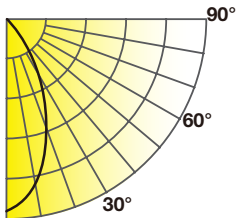

Lumens: 2,406 lm
 CBCP: 1,795 cd
 Power: 20 W
 Efficacy: 124 lm/W
 CRI: 92
 Spacing Criteria: 0.9
 Beam Angle: 67°

Candlepower Distribution		Initial Footcandles			Zonal Lumen Summary		
Angle (°)	Average (cd)	Height (ft)	Fc	Diameter (ft)	Zone	Lumens	%Fixt
10	1,649	10	25	13	0-10	164	7
20	1,349	20	6	26	0-20	589	25
30	1,011	30	3	39	0-30	1,136	47
40	667	40	2	53	0-60	2,248	93
50	344	50	1	66	0-90	2,403	100
60	144	60	1	79			
70	61	70	1	92			
80	30	80	0	105			
90	0	90	0	118			

SLFT8HO/9CCT5S/DUALDIM (at 3500K)

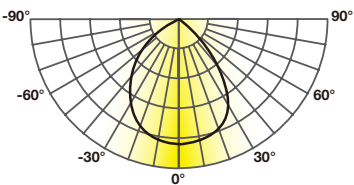

Lumens: 4,690 lm
 CBCP: 2,544 cd
 Power: 40 W
 Efficacy: 117 lm/W
 CRI: 92
 Spacing Criteria: 1.1
 Beam Angle: 83°

Candlepower Distribution		Initial Footcandles			Zonal Lumen Summary		
Angle (°)	Average (cd)	Height (ft)	Fc	Diameter (ft)	Zone	Lumens	%Fixt
10	2,471	10	37	18	0-10	239	5
20	2,261	20	9	36	0-20	910	19
30	1,918	30	4	53	0-30	1,879	40
40	1,372	40	2	71	0-60	4,254	91
50	804	50	1	89	0-90	4,681	100
60	373	60	1	107			
70	176	70	1	125			
80	84	80	1	142			
90	0	90	0	160			

SELECTFIT G2 SERIES

PHOTOMETRY

SLFT8HO/9CCT5S/DUALDIM + SLFT8/MD/OPTIC (at 3500K)

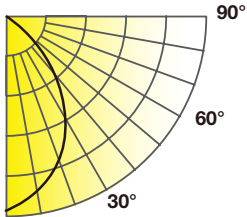

Lumens: 4,790 lm
 CBCP: 3,495 cd
 Power: 40 W
 Efficacy: 123 lm/W
 CRI: 92
 Spacing Criteria: 0.9
 Beam Angle: 67°

Candlepower Distribution		Initial Footcandles			Zonal Lumen Summary		
Angle (°)	Average (cd)	Height (ft)	Fc	Diameter (ft)	Zone	Lumens	%Fixt
10	3,233	10	48	13	0-10	321	7
20	2,662	20	12	27	0-20	1,153	24
30	2,006	30	5	40	0-30	2,230	47
40	1,329	40	3	53	0-60	4,465	93
50	705	50	2	67	0-90	4,781	100
60	300	60	1	80			
70	124	70	1	93			
80	59	80	1	107			
90	0	90	1	120			

SLFT9.5/9CCT5S/DUALDIM (at 3500K)

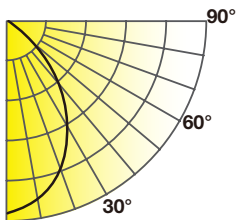

Lumens: 4,952 lm
 CBCP: 2,260 cd
 Power: 40 W
 Efficacy: 131 lm/W
 CRI: 92
 Spacing Criteria: 1.2
 Beam Angle: 95°

Candlepower Distribution		Initial Footcandles			Zonal Lumen Summary		
Angle (°)	Average (cd)	Height (ft)	Fc	Diameter (ft)	Zone	Lumens	%Fixt
10	2,220	10	33	22	0-10	214	4
20	2,095	20	8	43	0-20	825	17
30	1,843	30	4	65	0-30	1,738	35
40	1,469	40	2	87	0-60	4,388	89
50	987	50	1	108	0-90	4,942	100
60	492	60	1	130			
70	228	70	1	151			
80	109	80	1	173			
90	0	90	0	195			

Note: All rights reserved. All sizes and specifications are subject to change at any time without notice.