

Alphalite

LED LINEAR RETROFIT KIT

DESCRIPTION

The RXL LED Linear Strip Retrofit Kit series combines the benefits of long life, controllability, and energy savings with elegant design and superior quality of light. The RXL retrofit solution optimizes LED optics and electronics to deliver energy savings and high performance while being extremely quick and easy to install.

APPLICATION

Versatile upgrade solution for existing general purpose strip luminaires. Ideal for parking garages, corridors, hallways, stairwells, offices, closets, storage rooms, warehouse, manufacturing facilities, and spaces that demand energy demand reduction and high quality light.

SPECIFICATION FEATURES

Construction

Reflector utilizes highly reflective powder coat finish. Diffuser lens provides even and consistent light while eliminating pixelation. Tool-less removal of diffuser allows access to LED array. LED module and driver are replaceable. Universal reflector brackets accommodate various strip widths. Easy and convenient installation utilizes existing luminaire body, reduces labor hours. Integrated driver eliminates additional labor. Housing and optics maintain damp location rating with all internal components.

Electrical

Luminaire utilizes long life, high efficacy LEDs and a highly efficient, reliable LED driver. 120V-277V input voltage for increased versatility. 0-10V continuous dimming comes standard. Ideal when used in conjunction with controls and sensors. Comes equipped with quick disconnect for compliance with US code.

Finish

Highly reflective finish. Baked white paint, applied after fabrication.

Mounting

Installs on existing fluorescent strip fixtures. Utilizes existing luminaire body, eliminating the need to remove and dispose of old hardware. No need to re-mount or re-hang strip fixture. Universal reflector bracket accommodates various fixture widths.

Optics

The RXL's LED light engine and integrated optics delivers enhanced light quality and distribution. Precision-formed diffuser and reflector are designed LED light consistently, reducing glare and pixelation.

Certifications / Regulatory

All components used have UL approval. UL Class 2. Power supply: SCP, OTP, OVP protection, FCC Part 15 Class B, UL8750 Class 2. DLC Listed.

Warranty

7-year limited warranty. See complete warranty terms for details.



RXL Series

LED Linear Retrofit Kit Series



Quick Ship Product

- RXL-8L(38S)/840
- RXL-8L(38S)/850
- RXL-8H(54S)/840
- RXL-8H(54S)/850
- RXL-4L(23S)/840
- RXL-4L(23S)/850
- RXL-4H(32S)/840
- RXL-4H(32S)/850

ORDERING INFORMATION

Sample Number: RXL-8H(54S)/840

RXL	8	H	8	40	(Blank)	(Blank)
Series	Form Factor	Lumen Package	CRI	CCT	Input Voltage	Dimming
RXL - LED Linear Retrofit Kit	8 - 8' 4 - 4'	L - Low Wattage H - High Lumen VH - Very High Lumen *See energy data for details	8 - 83+ CRI	35 - 3500K 40 - 4000K 50 - 5000K	(Blank) - 120V-277V	(Blank) - 0-10V Continuous Dimming

Options

Controls

- OS** - Integrated step dimming PIR occupancy sensor (Field install required)
- MMS** - Integrated step dimming microwave motion sensor with sync function
- DL** - Integrated daylight harvesting
- SMC** - Smart Control System

Emergency Backup

- EM700 - 700lm
- EM1400 - 1400lm
- EM2000 - 2000lm



Specifications and dimensions subject to change without notice.

10715 Springdale Ave, Ste 4, Santa Fe Springs, CA 90670 Tel: 888.287.9228 Fax: 888.258.9183 www.alphalite.com

SUMMARY

Input Voltage	120V-277V
Input Power	See energy data for details
Power Factor	> 0.90
THD (Max.)	20%
Efficacy	> 125 LPW
Delivered Lumens	See energy data for details
Controls/ Dimming	Full Range 0-10V dimming standard
Dimming Range	10-100%
CRI	> 80
CCT	3500K, 4000K, 5000K
Operating Temp.	-20- +55C
Rated Life	70,000 hours

ENERGY PERFORMANCE DATA

Form Factor	Part No.	Rated Wattage (W)	Tested Wattage (W)	Delivered Lumens (lm)	Efficacy (lm/W)
8'	RXL-8L(38S)/835	38	37	4742	129
	RXL-8L(38S)/840			4940	130
	RXL-8L(38S)/850			4978	131
	RXL-8H(54S)/835	54	54	7128	132
	RXL-8H(54S)/840			7182	133
	RXL-8H(54S)/850			7315	135
	RXL-8H(65S)/835	65	65	8450	130
	RXL-8H(65S)/840			8580	132
	RXL-8H(65S)/850			8645	133
	RXL-8VH(90S)/835	90	90	11520	128
RXL-8VH(90S)/840	11700			130	
RXL-8VH(90S)/850	11790			131	
4'	RXL-4L(23S)/835	23	22	2750	125
	RXL-4L(23S)/840			2990	130
	RXL-4L(23S)/850			2989	130
	RXL-4H(32S)/835	32	30	3859	129
	RXL-4H(32S)/840			4224	132
	RXL-4H(32S)/850			4180	133
	RXL-4VH(46S)/835	46	45	5679	127
	RXL-4VH(46S)/840			5980	130
RXL-4VH(46S)/850	6026			131	

* DLC Standard

PHYSICAL PARAMETERS

DIMENSION

RXL- 4

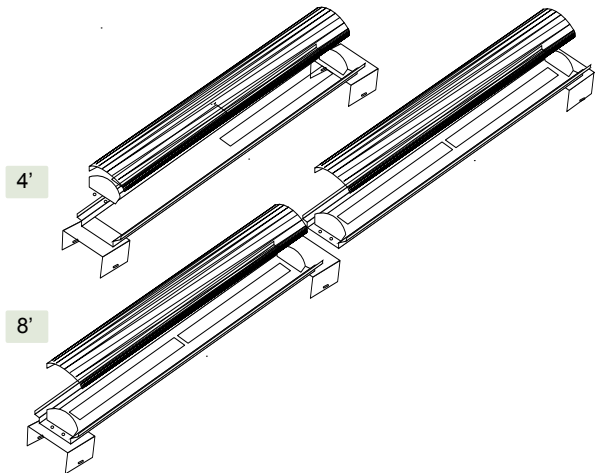
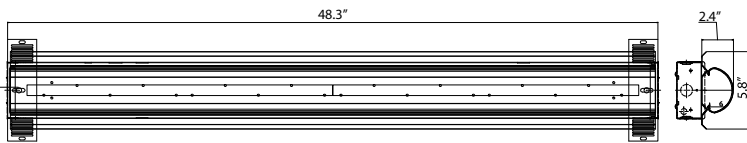

RXL- 8

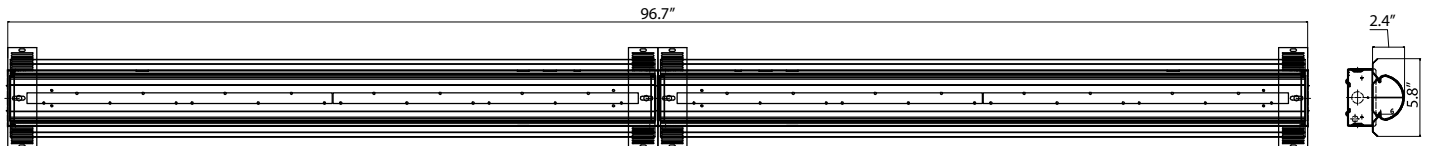

MOUNTING OPTIONS

Adjustable width bracket
(4 1/8" - 6 3/4")

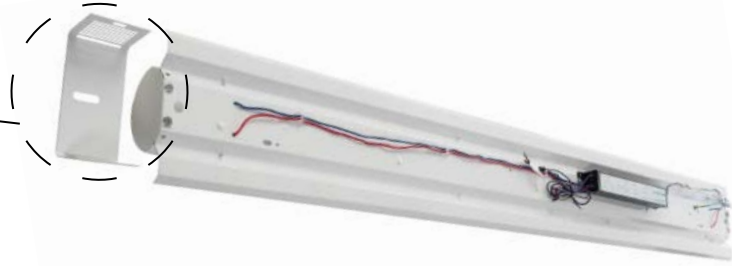

PHOTOMETRICS

RXL-4L(23S)/835

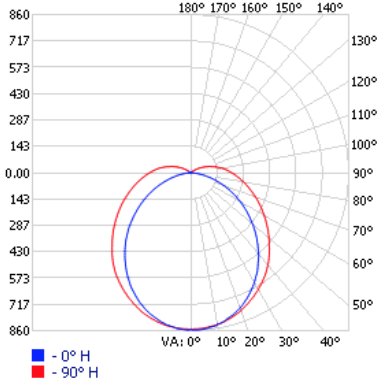

ZONE	LUMENS	% LUMINAIRE
0-30	655.7	22.60%
0-40	1,069.50	36.90%
0-60	1,893.00	65.30%
60-90	767.8	26.50%
70-100	559.3	19.30%
90-120	223.3	7.70%
0-90	2,660.80	91.80%
90-180	236.7	8.20%
0-180	2,897.50	100%

Coefficients of Utilization - Zonal Cavity Method

RCC	EFFECTIVE FLOOR CAVITY REFLECTANCE: 20%																	
	80		70		50		30		10		0							
RW %:	70	50	30	0	70	50	30	0	50	30	20	50	30	20	50	30	20	0
RCR: 0	1.17	1.17	1.17	1.17	1.13	1.13	1.13	0.92	1.07	1.07	1.07	1	1	1	0.95	0.95	0.95	0.92
1	1.05	0.99	0.94	0.89	1.01	0.96	0.91	0.73	0.9	0.86	0.83	0.85	0.82	0.79	0.8	0.77	0.75	0.72
2	0.95	0.85	0.78	0.72	0.91	0.83	0.76	0.6	0.78	0.72	0.67	0.73	0.69	0.64	0.69	0.65	0.62	0.59
3	0.86	0.75	0.66	0.59	0.83	0.72	0.64	0.51	0.68	0.61	0.56	0.64	0.59	0.54	0.61	0.56	0.52	0.49
4	0.79	0.66	0.57	0.5	0.75	0.64	0.55	0.43	0.6	0.53	0.47	0.57	0.51	0.46	0.54	0.49	0.44	0.42
5	0.72	0.59	0.49	0.42	0.69	0.57	0.48	0.38	0.54	0.46	0.41	0.51	0.45	0.39	0.48	0.43	0.38	0.36
6	0.67	0.53	0.44	0.37	0.64	0.51	0.43	0.33	0.49	0.41	0.35	0.46	0.4	0.34	0.44	0.38	0.34	0.31
7	0.62	0.48	0.39	0.33	0.59	0.47	0.38	0.29	0.44	0.37	0.31	0.42	0.35	0.31	0.4	0.34	0.3	0.28
8	0.57	0.44	0.35	0.29	0.55	0.43	0.34	0.26	0.4	0.33	0.28	0.39	0.32	0.27	0.37	0.31	0.27	0.25
9	0.54	0.4	0.32	0.26	0.52	0.39	0.31	0.24	0.37	0.3	0.25	0.36	0.29	0.25	0.34	0.28	0.24	0.22
10	0.5	0.37	0.29	0.23	0.49	0.36	0.28	0.22	0.34	0.28	0.23	0.33	0.27	0.22	0.32	0.26	0.22	0.2

RXL-4H(32S)/835

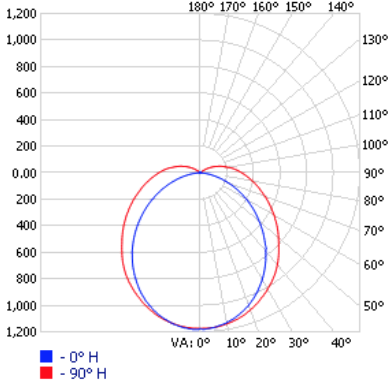

ZONE	LUMENS	% LUMINAIRE
0-30	904.8	22.50%
0-40	1,476.30	36.60%
0-60	2,616.10	64.90%
60-90	1,069.70	26.50%
70-100	782.5	19.40%
90-120	322.6	8%
0-90	3,685.80	91.50%
90-180	344.1	8.50%
0-180	4,029.90	100%

Coefficients of Utilization - Zonal Cavity Method

RCC	EFFECTIVE FLOOR CAVITY REFLECTANCE: 20%																	
	80		70		50		30		10		0							
RW %:	70	50	30	0	70	50	30	0	50	30	20	50	30	20	50	30	20	0
RCR: 0	1.17	1.17	1.17	1.17	1.13	1.13	1.13	0.91	1.06	1.06	1.06	1	1	1	0.94	0.94	0.94	0.91
1	1.05	0.99	0.94	0.89	1.01	0.96	0.91	0.73	0.9	0.86	0.83	0.84	0.81	0.79	0.79	0.77	0.75	0.72
2	0.94	0.85	0.78	0.71	0.91	0.83	0.76	0.6	0.78	0.72	0.67	0.73	0.68	0.64	0.69	0.65	0.61	0.59
3	0.86	0.74	0.66	0.59	0.83	0.72	0.64	0.5	0.68	0.61	0.55	0.64	0.58	0.53	0.6	0.56	0.51	0.49
4	0.78	0.66	0.56	0.49	0.75	0.64	0.55	0.43	0.6	0.53	0.47	0.57	0.5	0.45	0.54	0.48	0.44	0.41
5	0.72	0.59	0.49	0.42	0.69	0.57	0.48	0.37	0.54	0.46	0.4	0.51	0.44	0.39	0.48	0.43	0.38	0.36
6	0.66	0.53	0.43	0.37	0.64	0.51	0.43	0.33	0.49	0.41	0.35	0.46	0.39	0.34	0.44	0.38	0.33	0.31
7	0.62	0.48	0.39	0.32	0.59	0.46	0.38	0.29	0.44	0.37	0.31	0.42	0.35	0.3	0.4	0.34	0.3	0.27
8	0.57	0.43	0.35	0.29	0.55	0.42	0.34	0.26	0.4	0.33	0.28	0.38	0.32	0.27	0.37	0.31	0.26	0.24
9	0.53	0.4	0.32	0.26	0.52	0.39	0.31	0.24	0.37	0.3	0.25	0.35	0.29	0.24	0.34	0.28	0.24	0.22
10	0.5	0.37	0.29	0.23	0.48	0.36	0.28	0.21	0.34	0.27	0.23	0.33	0.27	0.22	0.31	0.26	0.22	0.2

RXL-4VH(46S)/835

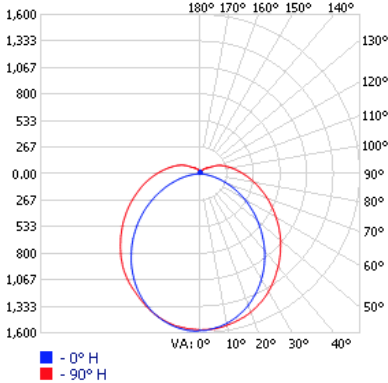

ZONE	LUMENS	% LUMINAIRE
0-30	1,060.80	21.60%
0-40	1,741.60	35.50%
0-60	3,134.50	63.80%
60-90	1,358.30	27.70%
70-100	1,002.90	20.40%
90-120	397.8	8.10%
0-90	4,492.80	91.50%
90-180	419.4	8.50%
0-180	4,912.20	100%

Coefficients of Utilization - Zonal Cavity Method

RCC	EFFECTIVE FLOOR CAVITY REFLECTANCE: 20%																	
	80		70		50		30		10		0							
RW %:	70	50	30	0	70	50	30	0	50	30	20	50	30	20	50	30	20	0
RCR: 0	1.17	1.17	1.17	1.17	1.13	1.13	1.13	0.91	1.06	1.06	1.06	1	1	1	0.94	0.94	0.94	0.91
1	1.04	0.99	0.93	0.89	1.01	0.95	0.91	0.72	0.89	0.86	0.82	0.84	0.81	0.78	0.79	0.77	0.74	0.71
2	0.94	0.85	0.77	0.71	0.91	0.82	0.75	0.59	0.77	0.71	0.66	0.72	0.68	0.63	0.68	0.64	0.61	0.58
3	0.85	0.74	0.65	0.58	0.82	0.72	0.63	0.5	0.67	0.6	0.55	0.63	0.58	0.53	0.6	0.55	0.51	0.48
4	0.78	0.65	0.56	0.49	0.75	0.63	0.54	0.42	0.6	0.52	0.46	0.56	0.5	0.45	0.53	0.48	0.43	0.41
5	0.71	0.58	0.48	0.42	0.69	0.56	0.47	0.37	0.53	0.46	0.4	0.5	0.44	0.38	0.48	0.42	0.37	0.35
6	0.66	0.52	0.43	0.36	0.63	0.51	0.42	0.32	0.48	0.4	0.35	0.45	0.39	0.34	0.43	0.37	0.33	0.3
7	0.61	0.47	0.38	0.32	0.59	0.46	0.37	0.28	0.43	0.36	0.3	0.41	0.35	0.3	0.39	0.33	0.29	0.27
8	0.57	0.43	0.34	0.28	0.55	0.42	0.34	0.25	0.4	0.32	0.27	0.38	0.31	0.26	0.36	0.3	0.26	0.24
9	0.53	0.39	0.31	0.25	0.51	0.38	0.3	0.23	0.37	0.29	0.24	0.35	0.28	0.24	0.33	0.27	0.23	0.21
10	0.5	0.36	0.28	0.23	0.48	0.35	0.28	0.21	0.34	0.27	0.22	0.32	0.26	0.22	0.31	0.25	0.21	0.19

-MMS control pre-commissioning**Sample Number: -MMS (10-3M-L3-S10M)**

10	3M	L3	S10M	(Blank)	
Detection Area 10 - 100% 7 - 75% 5 - 50% 1 - 10%	Hold Time 30M - 30 min. 20M - 20 min. 3M - 3 min. 30S - 30 sec. 5S - 5 sec.	Low Mode L5 - 50% L3 - 30% L2 - 20% L1 - 10%	Stand-by Period SN - ∞ S1H - 1 hr. S30M - 30 min. S10M - 10 min. S5M - 5 min. S5S - 5 sec. (Blank) - Disable	Daylight Sensor (Blank) - Disable D100 - 100 lux D50 - 50 lux D25 - 25 lux D10 - 10 lux D5 - 5 lux D2 - 2 lux	
<p>Detection Area: Detection area can be reduced to fit precisely each application.</p> <p>Hold Time: The time period the luminaire remains at 100% illumination after no motion detected.</p> <p>Low Mode: The selected low light level after the hold time.</p> <p>Stand-by Period: The time period the luminaire remains at "Low Mode" before it completely switched off in the long absence of people. When set to "∞" mode, the low light level is maintained until motion is detected.</p> <p>Daylight Sensor: The sensor can be set to only allow the luminaire to illuminate below a defined ambient brightness threshold. When set to "Disable" mode, the daylight sensor will switch on the luminaire when motion is detected regardless of ambient light level.</p> <p>**Noted that daylight sensor is active only when the luminaire switches off**</p>					

-OS control pre-commissioning**Sample Number: -OS (L2-5M-L3-S10M)**

L2	(Blank)	5M	L3	S10M	(Blank)	(Blank)	(Blank)
Lens / Coverage L2 - 8'H (48' dia.) L3 - 20'H (40' dia.) L4 - 40'H (60' dia.) L7 - 40'H (100' dia.)	High Mode (Blank) - 100% H9 - 90% H8 - 80% H7 - 70%	Hold Time #M - 1-30 min. 30S - 30 sec.	Low Mode L5 - 50% L3 - 30% L2 - 20% L1 - 10%	Stand-by Period SN - ∞ S#H - 1-5 hrs. S#M - 1-59 min. (Blank) - Disable	Ramp Up (Blank) - Disable #Up - 1-60 sec.	Fade Down (Blank) - Disable #Dn - 1-60 sec.	Photocell On/Off (Blank) - Disable PS - Active
<p>High Mode: The selected high light level when motion detected.</p> <p>Hold Time: Time period the luminaire remains at "High Mode" after no motion detected.</p> <p>Low Mode: The selected low light level after the hold time.</p> <p>Stand-by Period: Time period the luminaire remains at "Low Mode" before it completely switched off in the long absence of people. When set to "∞" mode, the low light level is maintained until motion is detected.</p> <p>Ramp Up: Time period for light level to increase from LOW to HIGH.</p> <p>Fade Down: Time period for light level to decrease from HIGH to LOW.</p> <p>Photocell On/Off: When the light level exceeds this setting, the lights will turn off even when the space is occupied. Once the light level exceeds this setting, the sensor will wait and monitor for a short period of time in order to confirm the light level increase is not temporary before forcing the lights to go off. When light level goes below the settings, the light will turn on even without motion detection. This feature is disabled by default. If using this setting in combination with the Hold Off set-point, there must be at least 10fc of dead band between the two settings. The Photocell set-point is automatically set to maintain at least 10fc of dead band above the Hold time set-point to help avoid load cycling.</p>							