

# Installation Instructions

## LED IP Rated High Bay

Installation guide valid for the following models:

**RWUX-(150/100/75)/8A**

**RWUX-(240/200/150)/8A**

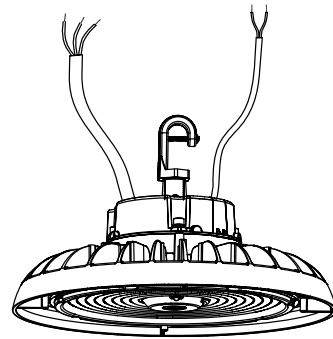

### WARNING

#### RISK OF FIRE OR ELECTRIC SHOCK

The LED IP Rated High Bay must be installed by a qualified electrician in accordance with applicable federal, state, and local laws and codes. Installation requires knowledge of luminaire electrical systems and installer should be familiar with the operation of this product. If not qualified, do not attempt installation; contact a qualified electrician. Manufacturer assumes no responsibility for the improper installation of this luminaire. When installing the fixture, drilling may damage luminaire wiring and electrical parts. Check for wiring and components in enclosure before drilling.

### WARNING

To prevent wiring damage or abrasion, do not expose wiring to edges of sheet metal or other sharp objects. When installing this kit, drilling may damage luminaire wiring and electrical parts. Check for wiring and components in enclosure before drilling.

### CAUTION

#### RISK OF PERSONAL INJURY

- Wear gloves or proper handling protection to prevent cuts or abrasions when handling and maintaining this product. This equipment may have sharp edges. To reduce the risk of death, personal injury or property damage from fire, electric shock, falling parts, cuts/abrasions, and other hazards read all warning and instructions included with and on the fixture box and all fixture labels.
- Avoid direct eye exposure to the light source while it is on.

### WARNING

#### RISK OF PERSONAL INJURY, FIRE OR ELECTRIC SHOCK

Turn OFF power before installation.

### NOTICE

- Green ground screw provided in proper location. Do not relocate.
- Minimum 90° supply conductors.
- Specifications and dimensions subject to change without notice.
- Suitable for Dry or Damp location.



Contact manufacturer with any questions or concerns regarding installation of this luminaire.

# Alphalite

# Installation Instructions

## LED IP Rated High Bay

### A: Hanging Mount (Hook or Ring)

#### Standard equipped Hook, optional Ring RWUX-RMK

1. Screw the hook or Ring into the fixture, tighten and fix it. (figure 1)
2. Hang the fixture on the ceiling hook or chain. (figure 2)
3. Loop the safety cable around a structural member of the building providing a secondary support for the mounted fixture. (figure 13)
4. Connect the wires of the fixture to the mains according to local wiring rules, ensure the connection is stable and make good protection on the connection.

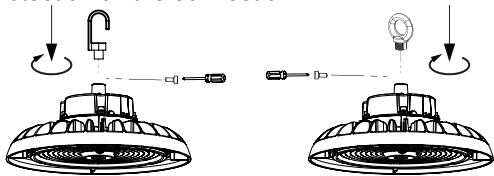

Figure 1

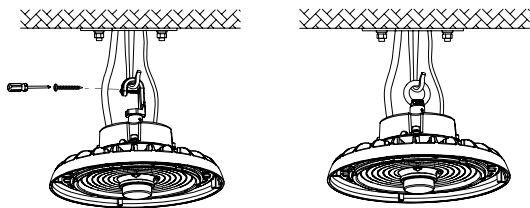

Figure 2

### C: Pendant mount (for 1/2" stem)

(The power cable passes thru the inside of stem)

#### Item No. RWUX-SMK

1. Unscrew the nuts on 1/2" stem (not provided) and insert it into the hole of RWUX-SMK (figure 6)
3. Re-screw the nut and loop the safety cable around a structural member of the building providing a secondary support for the mounted fixture.
4. Connect the wires of the fixture to the mains according to local wiring rules, ensure the connection is stable and make good protection on the connection (figure 10)
5. the RWUX-SMK supports adjust 50° to the left or right vertically by loosen and tighten the screws.

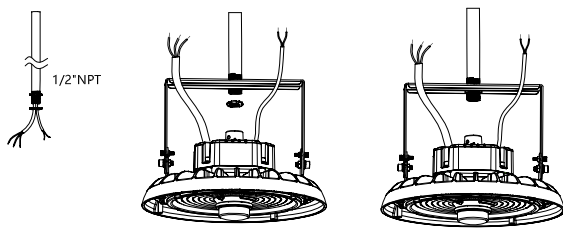

Figure 6

### B: Surface Mount

#### Item No. RWUX-SMK

1. Make a mark and drill the mounting surface and fix the screws (figure 3)
2. Install the RWUX-SMK on the fixture (figure 4)
3. Align the bracket holes with the screws, and push the fixture to one side and fix it. (figure 5)
4. Loop the safety cable around structural member (figure 13)
5. Connect the wires according to local wiring rules, ensure the connection is stable and good protection on the connection.
6. the RWUX-SMK supports adjust 50° to the left or right vertically by loosen and tighten the screws.

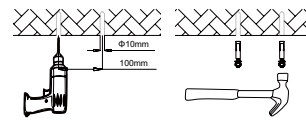

Figure 3

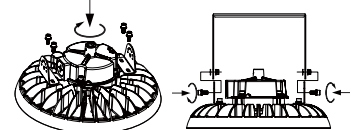

Figure 4

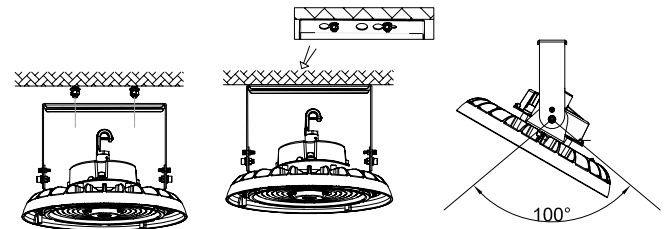

Figure 5

### D: Pendant mount (for 1/2" stem and 3/4" stem)

(Power cable doesn't pass thru the inside of stem, or with a hole on the side for cable, stems provided by others)

#### Optional RWUX-PMK3/4

1. Twist the 1/2" stem it into the hole of fixture. (figure 7)
2. Twist the RWUX-PMK3/4 into the hole of fixture, and then twist the 3/4" stem into the RWUX-PMK3/4. (figure 8)
3. Loop the safety cable around a structural member (figure 13)
4. Connect the wires of the fixture to the mains according to local wiring rules, ensure the connection is stable and make good protection on the connection.

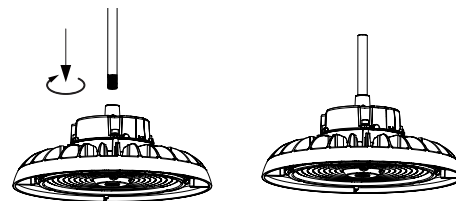

Figure 7

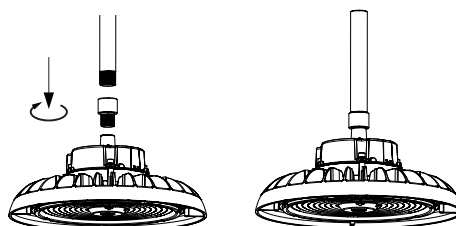

Figure 8

# Alphalite

# Installation Instructions

## LED IP Rated High Bay

### Accessory Installation (options)

#### 1. PIR / Microwave sensor (MMS-DC-PIR4T, MMS-DC4T)

- 1). Removed the 1/2" stopper from the fixture. (figure 9)
- 2). Twist-lock the DC sensor to the base (figure 10)
- 3). Be sure sensor is tighten befor use, setting the data according to the pec sheet of sensor and remote control RC-100.

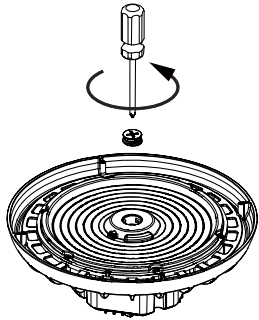

Figure 9

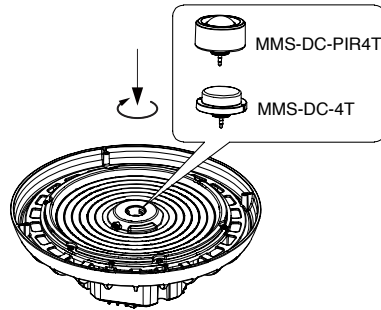

Figure 10

#### 2. Reflector Cone (RWUX-RPC, RWUX-RAL)

- 1). Lock the PC or Aluminum reflector to the fixture (figure 11)

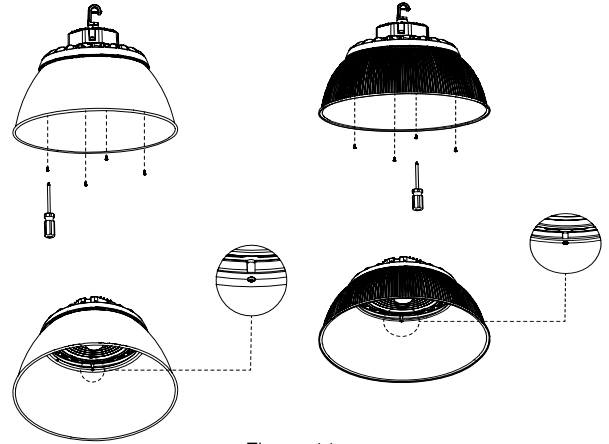

Figure 11

#### 3. Wire Guard (RWUX-WG)

- 1). Put the wire guard on the fixture and fix it. (figure 12)

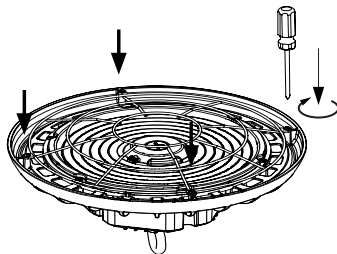

Figure 12

#### 4. Install safety cable

- 1). Loop the safety cable around a structural member of the building (figure 13)

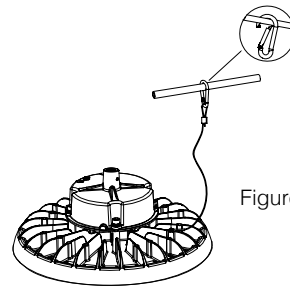

Figure 13

#### 5. Emergency (EM-RM40W-GW)

- 1). Install the EM according to EM spec sheet. (figure 14)

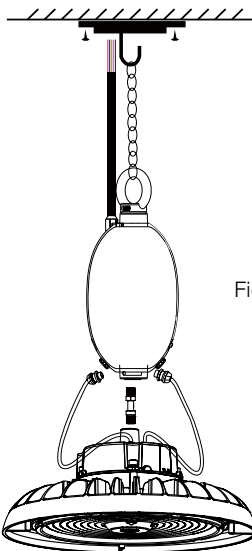

Figure 14

#### Wattage and CCT field adjust

- 1). Remove the stopper, pull the DIP switches to adjust the wattage and CCT, and then insert the stopper. (figure 15)

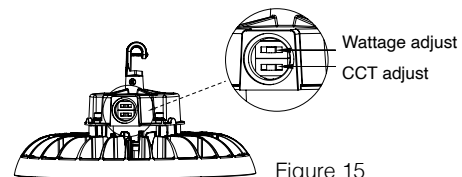

Figure 15

# Alphalite