

## MLE30-24DC-UD

**Class 2 Electronic UNIV 5 in 1 dimming**  
Outdoor Black Powder Coated Steel Enclosure  
Single Circuit: **24VDC 800Hz**  
Total Wattage: **30W max**  
Input Voltage: **100-277V 50/60Hz**

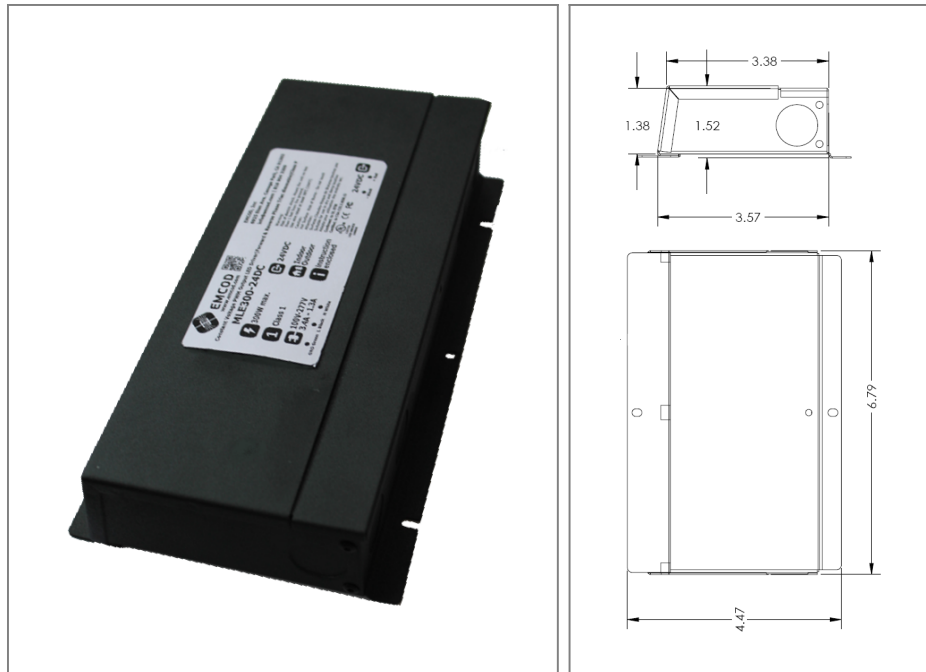

Conforms to UL STD. 8750 and 1310  
Certified to CSA  
STD. C22.2 No 250.0  
model MLE30-12DC-UD



### Transformer

Dimmable with triac forward and reverse phase, 0/1-10V , resistor, PWM  
Input leads are 18AWG 600V  
Output leads are 16AWG 300V  
Leads max. operational temperature is 105°C

### Housing

The actual transformer 30W is encapsulated in the enclosure  
The enclosure is Black Powder Coated Steel, NEMA 3R rated  
Wiring compartment has 6 knockouts sizes for 3/8 inch screw cable connectors  
Enclosure Temperature does not exceed 70°C at 45°C ambient and fully loaded  
Dimensions (inch): H = 4.47, W = 6.79, D = 1.38  
Weight (LBs): 1.8

### Electrical Parameters

Input Voltage:	<b>100-277V 50/60Hz</b>
Max. input current at full load:	<b>0.3A</b>
Output voltage without load:	<b>24.1VDC</b>
Output voltage fully loaded:	<b>24VDC</b>
Max. Total Wattage:	<b>30W</b>
Max. Output Current:	<b>1.2A</b>
Efficiency:	<b>87%</b>
Load regulation:	<b>1%</b>
Ripple:	<b>5%</b>

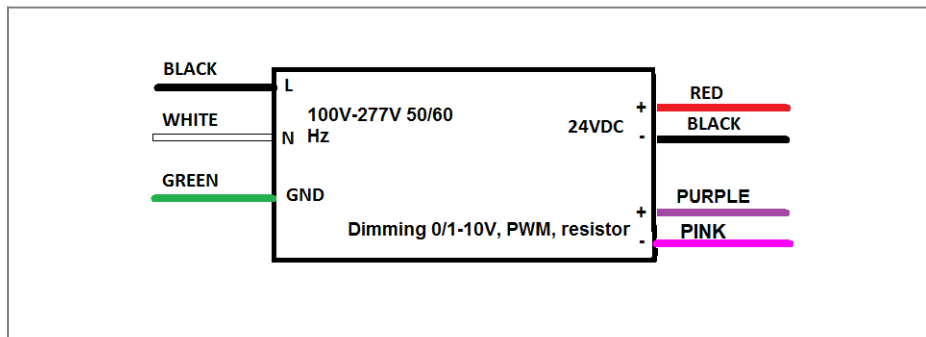

**Mailing Address: 646 Flinn Ave. Unit B, Moorpark , CA 93021 Tech support: Arik Nirenberg phone: 818-904-3309**  
**Fax: 818 904 3327 info@emcod.com techsupport@emcod.com**