

## MLE150-12DC-UD

### Electronic UNIV 5 in 1 dimming

Outdoor Black Powder Coated Steel Enclosure

Single Circuit: **12VDC 800Hz**

Total Wattage: **150W max**

Input Voltage: **100-277V 50/60Hz**



Conforms to UL STD. 8750 and 1310  
Certified to CSA  
STD. C22.2 No 250.0  
model MLE150-12DC-UD

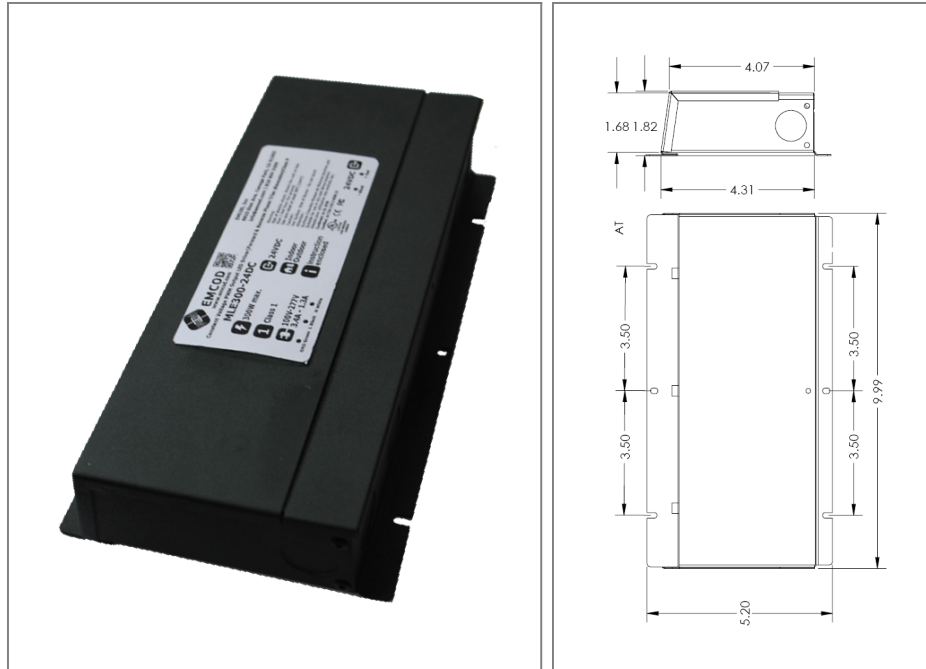

### Transformer

Dimmable with triac forward and reverse phase, 0/1-10V , resistor, PWM  
Input leads are 18AWG 600V  
Output leads are 16AWG 300V  
Leads max. operational temperature is 105°C

### Housing

The actual transformer 150W is encapsulated in the enclosure  
The enclosure is Black Powder Coated Steel, NEMA 3R rated  
Wiring compartment has 6 knockouts sizes for 3/8 inch screw cable connectors  
Enclosure Temperature does not exceed 70°C at 45°C ambient and fully loaded  
Dimensions (inch): H = 5.2, W = 9.99, D = 1.82  
Weight (LBs): 3

### Electrical Parameters

Input Voltage: **100-277V 50/60Hz**

Max. input current at full load: **1.8A**

Output voltage without load: **12.1VDC**

Output voltage fully loaded: **12VDC**

Max. Total Wattage: **150W**

Max. Output Current: **12.5A**

Efficiency: **87%**

Load regulation: **1%**

Ripple: **5%**

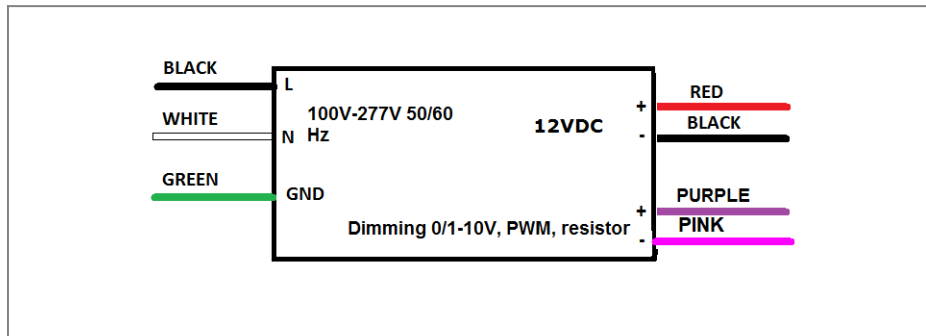

Mailing Address: 646 Flinn Ave. Unit B, Moorpark , CA 93021 Tech support: Arik Nirenberg phone: 818-904-3309  
Fax: 818 904 3327 info@emcod.com techsupport@emcod.com