

PRODUCT CATALOG

INNOVATIVE TECHNOLOGY+PRODUCTS

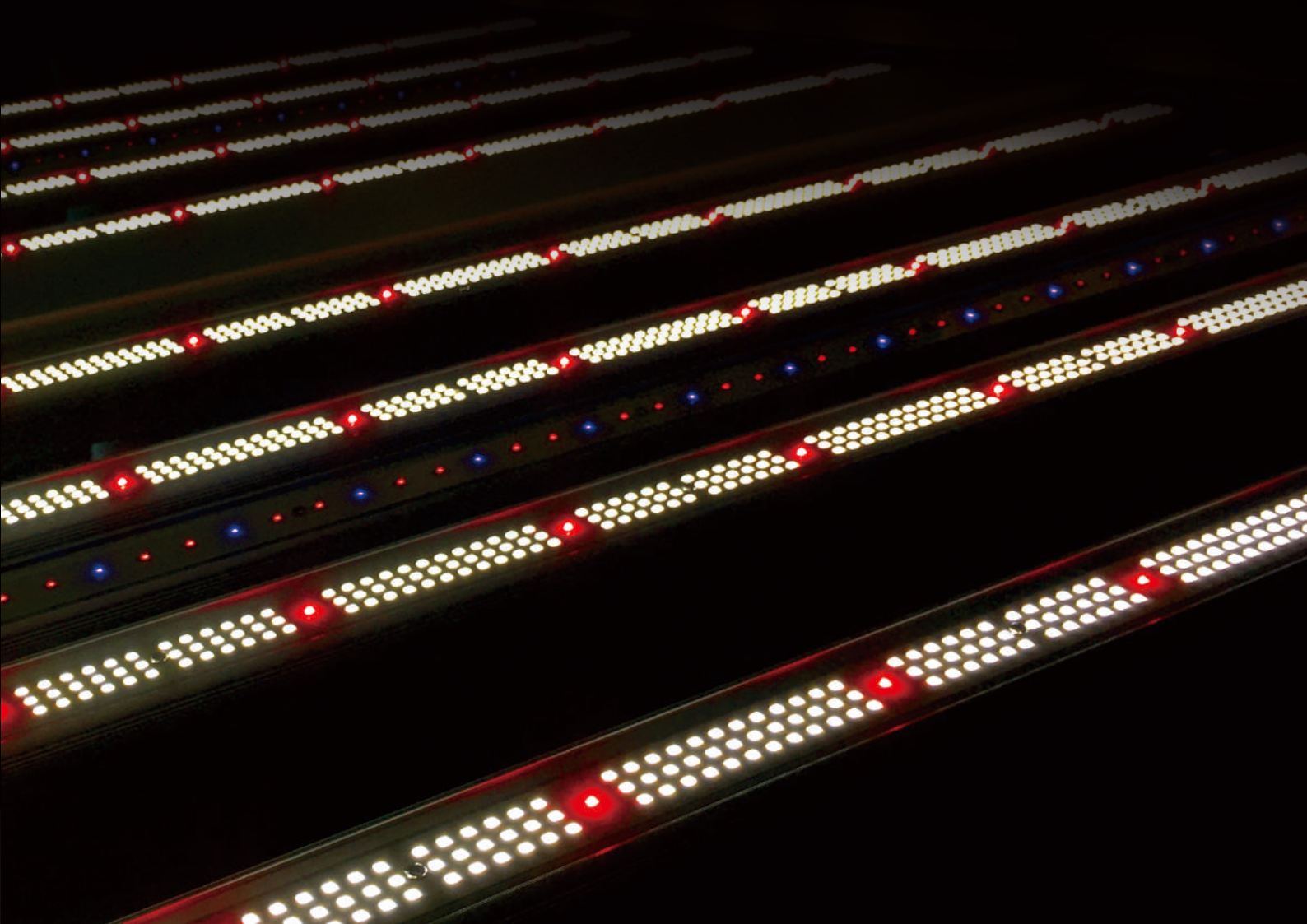



*Full Spectrum Tunable?
Time Scheduling?
Synchronization Chaining?*

**Here's what you need to know about
our amazingly smart MB4 LED Grow Light !**



MB4 MB4 Master MB4 Station

One master control 100 stations

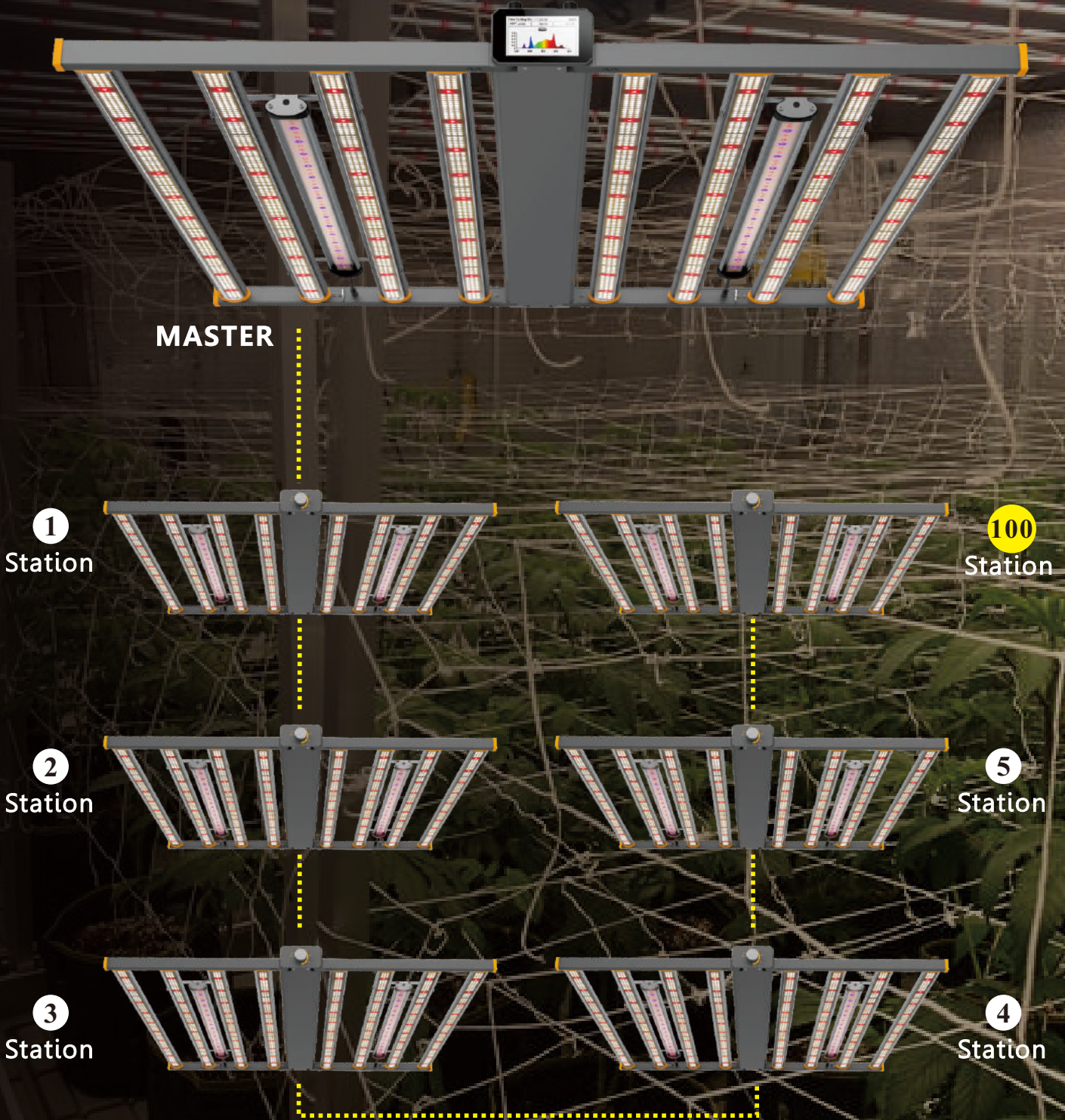

MAGIC BOOK 4

FIXTURE SPECIFICATIONS

	One fixture 4 spectrums tunable			
	Spectrum V1	Spectrum F1	Spectrum VS	Spectrum FS
Light source	Samsung+Osram LEDs			
PPF	1872 $\mu\text{Mol/s}$	2028 $\mu\text{Mol/s}$	2050 $\mu\text{Mol/s}$	2200 $\mu\text{Mol/s}$
Efficacy	2.6-2.8 $\mu\text{Mol/J}$			
Input power	720W	780W	820W	880W
Input voltage	AC120-277V, AC347-480V, 50/60Hz			
Fixture dimensions (L x W x H)	Master: 42.83 x 44.88 x 2.75 inch 1088 x 1140 x 70 mm		Station: 42.51 x 44.88 x 2.75 inch 1080 x 1140 x 70 mm	
Net Weight	31.96lbs / 14.5kg			
Dimming	0-10V			
Thermal management	Passive			
Max. Ambient Temperature	95°F/35°C			
Total Harmonic Distortion (THD)	<15%			
L90	50,000 hours			
Certifications	ETL, DLC, CE			

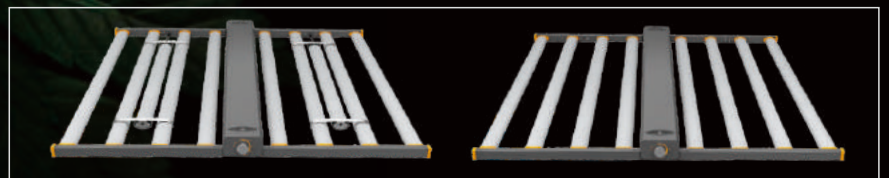
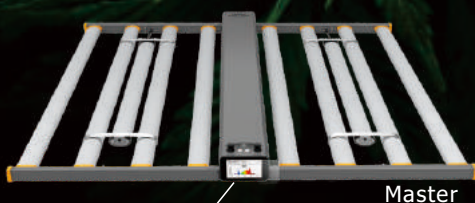

high-tech chips embedded



RED Button
F1 spectrum switch

UV+IR Button
UV+IR bar switch

Timer Knob
6hours/12hours/14hours / 16hours/18hours

Dimmer Knob
30% to 100% stepless dimming

LCD Display

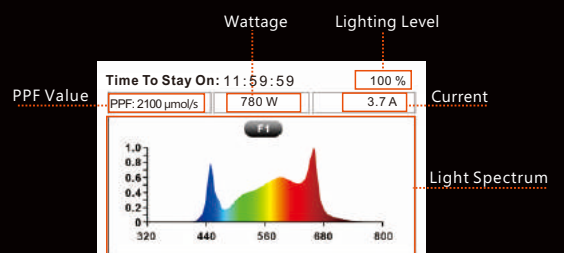

● Light ON Screen

MB4 Wireless Group Solution

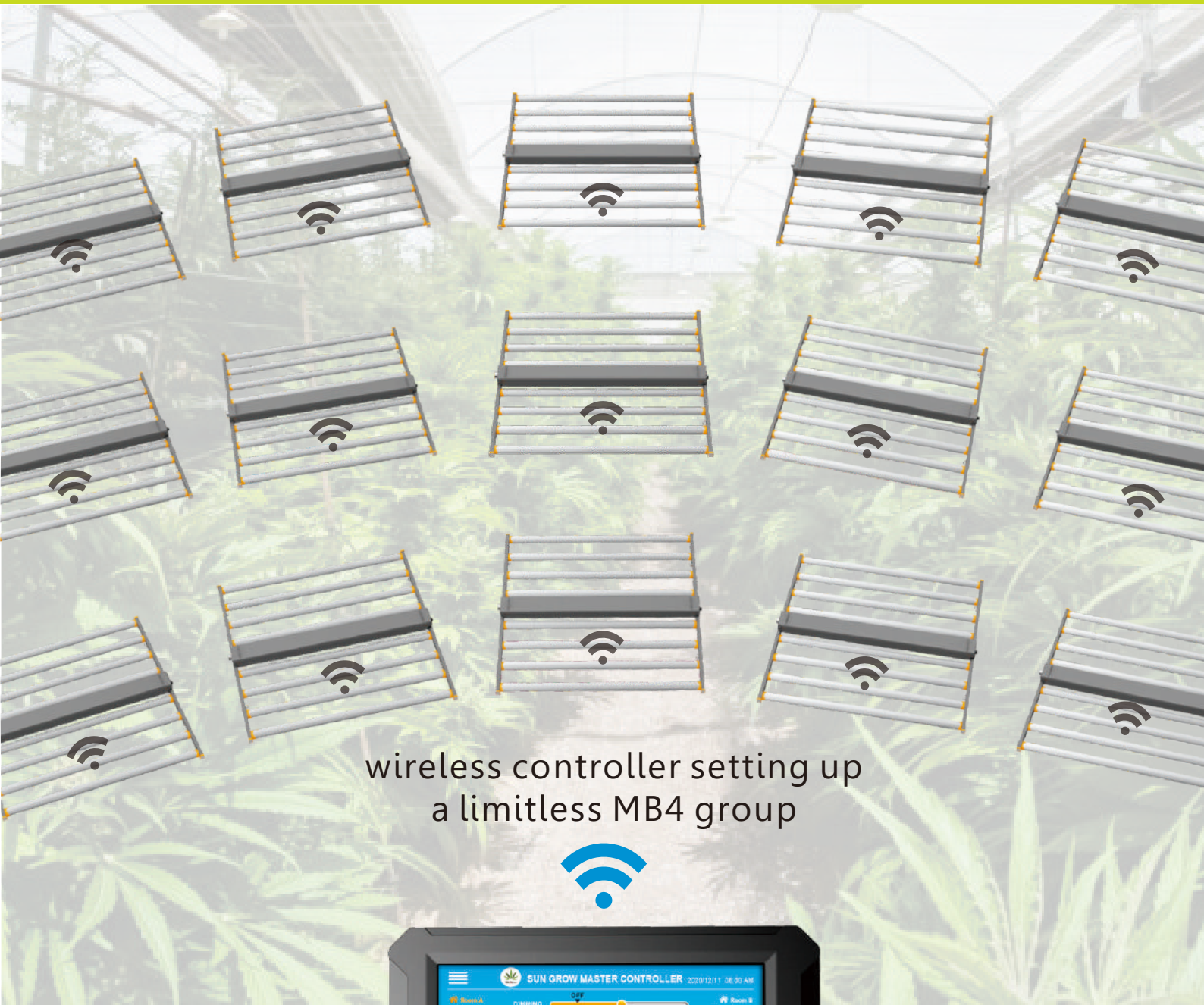

wireless controller setting up
a limitless MB4 group

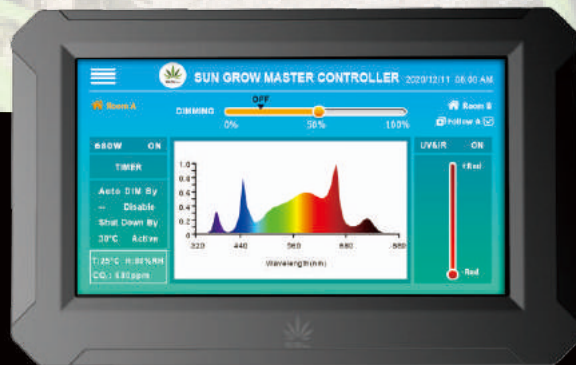

**Auto Wireless Group ,
Group with Unlimited Fixtures**

MAGIC BOOK 4

FIXTURE SPECIFICATIONS

4 Spectrum tunable

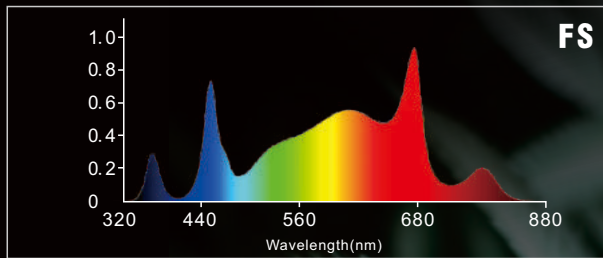
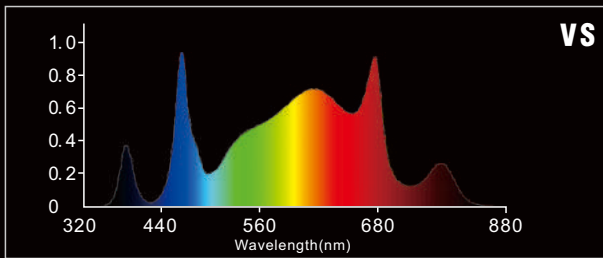
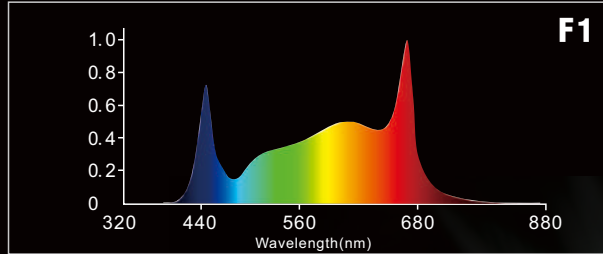
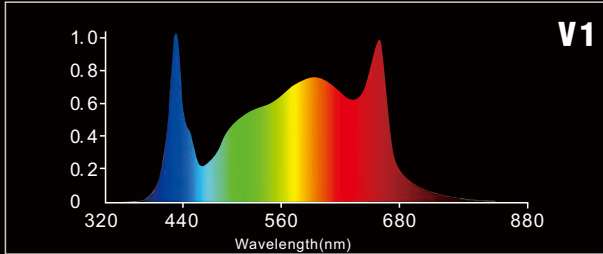

1.2M X 1.2M/4FT X 4FT

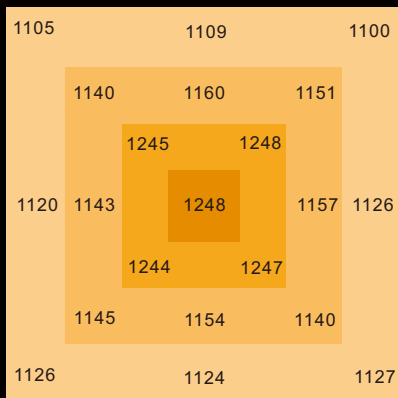

12" /305mm Height
MB4-720W V1 2.6 μMol/J

1.2M X 1.2M/4FT X 4FT

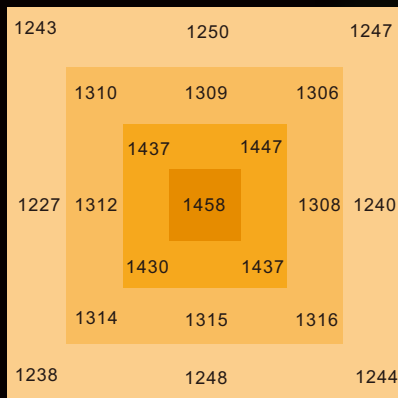

12" /305mm Height
MB4-780W F1 2.6 μMol/J

Smart installation

Our creative mechanism design enables you the most time-saving and a convenient way to install the fixture .

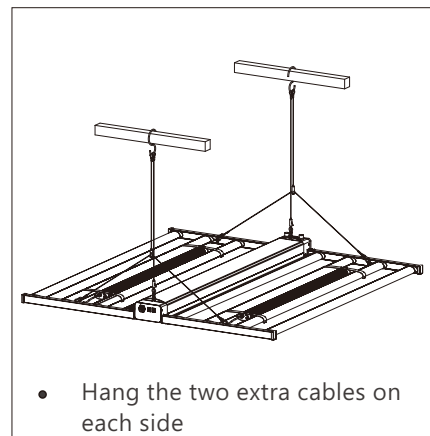
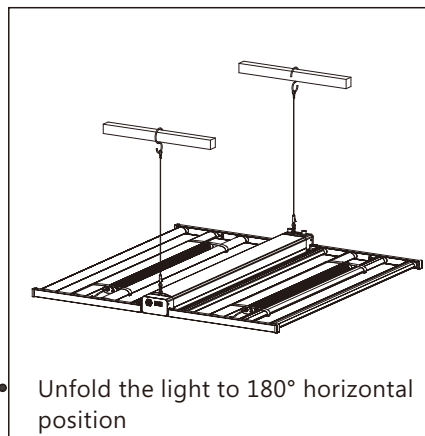
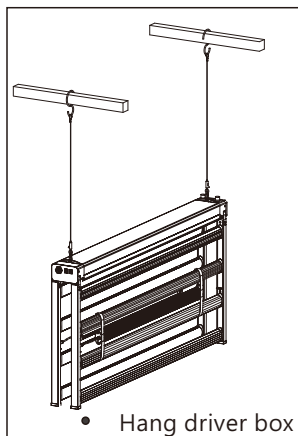

MAGIC BOOK 4S

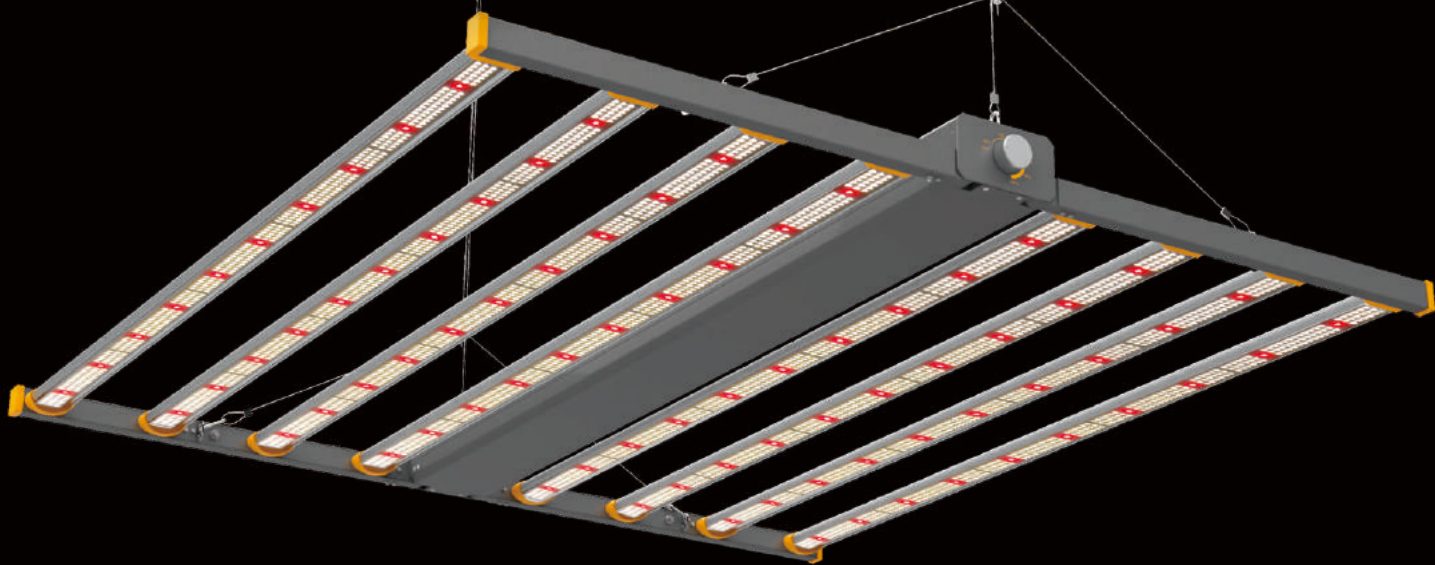

MB4 is too high level for you ??

MB4 S can meet your needs.



MAGIC BOOK 4 S

FIXTURE SPECIFICATIONS

Light source	Samsung+Osram LEDs
PPF	1872 $\mu\text{Mol/s}$
Efficacy	2.6-2.8 $\mu\text{Mol/J}$
Input power	720 W
Input voltage	AC120-277V, AC347-480V, 50/60Hz
Fixture dimensions (L x W x H)	42.51 x 44.88 x 2.75 inch 1080 x 1140 x 70 mm
Net Weight	27.55lbs /12.51kg
Dimming	0-10V stepless dimming
Thermal management	Passive
Max.Ambient Temperature	95°F/35°C
Total Harmonic Distortion(THD)	<15%
L90	50,000 hours
Certifications	ETL,DLC,CE

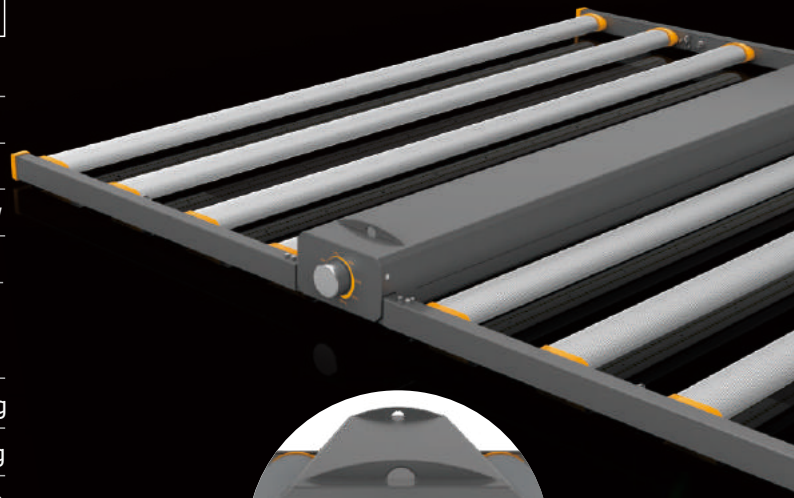

Stepless Dimmer

0-10V levels dimming function adjust lighting intensity as your plants need.

1.2M X 1.2M/4FT X 4FT

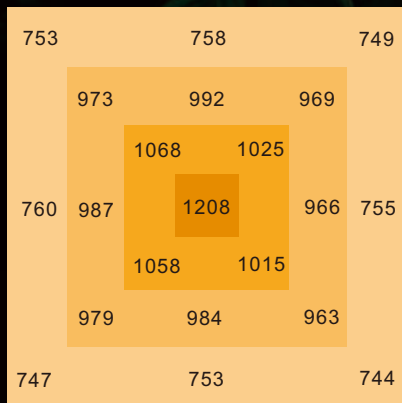

12" /305mm Height
MB4 S-720W 2.6 $\mu\text{Mol/J}$

1.2M X 1.2M/4FT X 4FT

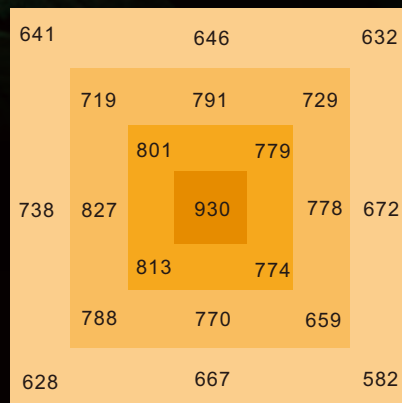

24" /609mm Height
MB4 S-720W 2.6 $\mu\text{Mol/J}$

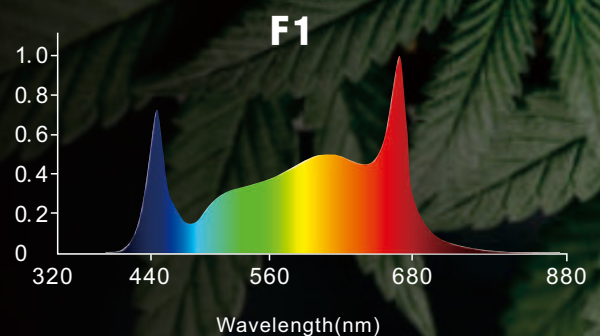
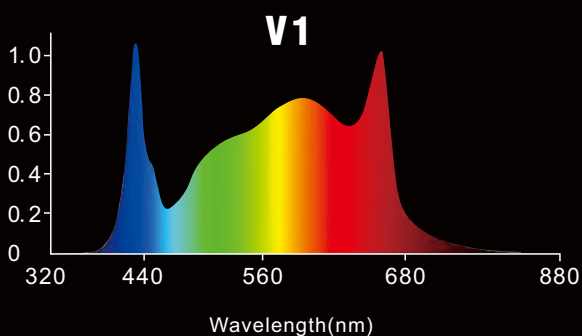



Timer Knob

(24-hour time system)
OFF/6Hours/12Hours
14Hours/16Hours/18Hours
(6 hrs=6 hours on,18 hours off in a
24 hours growing cycle)

Screen

Bloom
Press botton to switch
Spectrum from V1 to F1

Dimmer

EXT/OFF/100%/80%/60%/40%

Built-in controller

MAGIC BOOK 3 PRO

MB3 pro is a full-cycle top-lighting solution for commercial cannabis cultivation ,with the power to scale from vegetative growth to higher light intensities in bloom. The integrated LED display on the fixture create a smart but an easy way to control, it shows the selected spectrum, actual wattage, PPF value, time setting and more!

MAGIC BOOK 3 PRO

FIXTURE SPECIFICATIONS

Light source	Samsung+Osram LEDs
PPF	1976 $\mu\text{Mol/s}$
Efficacy	2.6-2.8 $\mu\text{Mol/J}$
Input power	760W
Input voltage	AC120-277V, AC347-480V, 50/60Hz
Fixture dimensions (L x W x H)	43.22L x 45.55W x 3.07H inch 1098 x 1157 x 78 mm
Net Weight	30.73lbs / 13.9kg
Dimming	0-10V
Thermal management	Passive
Max. Ambient Temperature	95°F/35°C
Total Harmonic Distortion (THD)	<15%
L90	50,000 hours
Certifications	ETL, DLC, CE

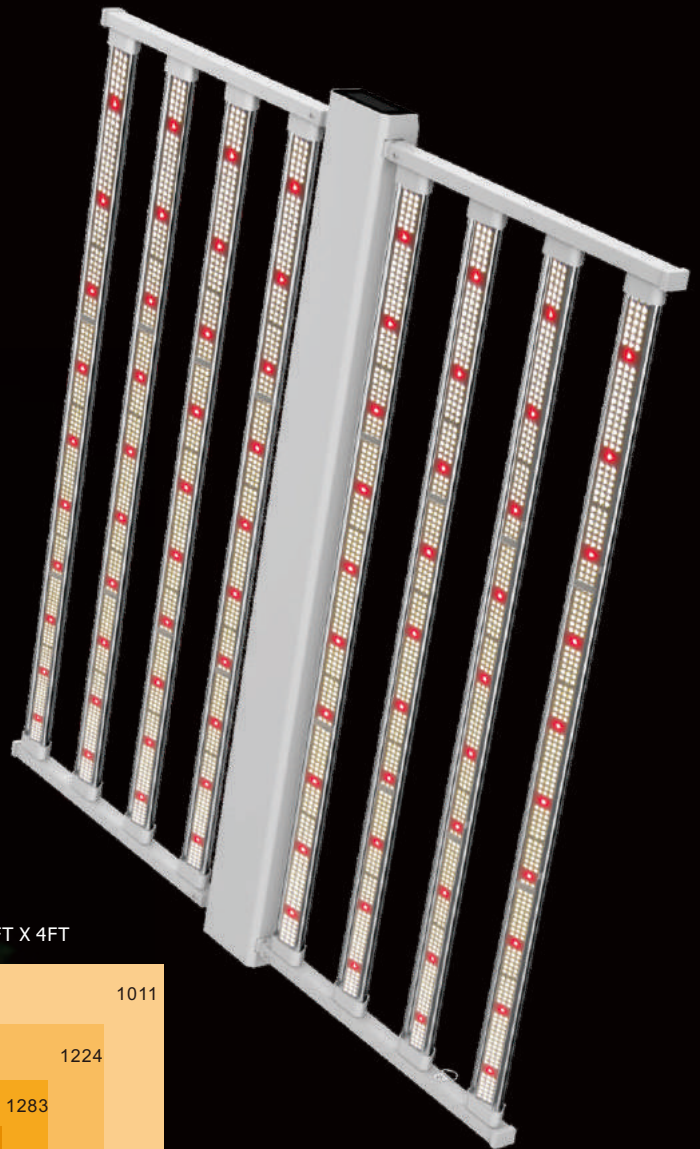

1.2M X 1.2M/4FT X 4FT

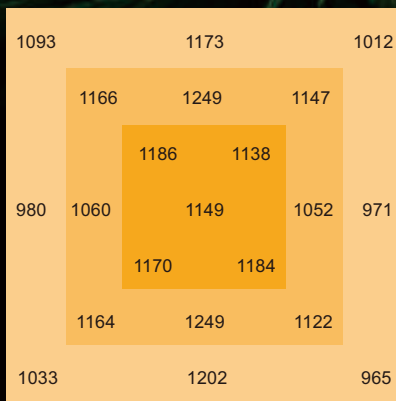

12" /305mm Height
MB3 pro-700W V1 2.6 $\mu\text{Mol/J}$

1.2M X 1.2M/4FT X 4FT

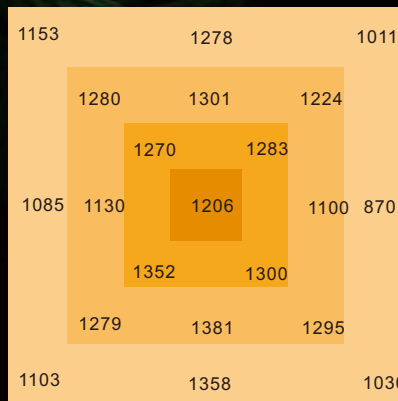

12" /305mm Height
MB3 pro-760W F1 2.6 $\mu\text{Mol/J}$

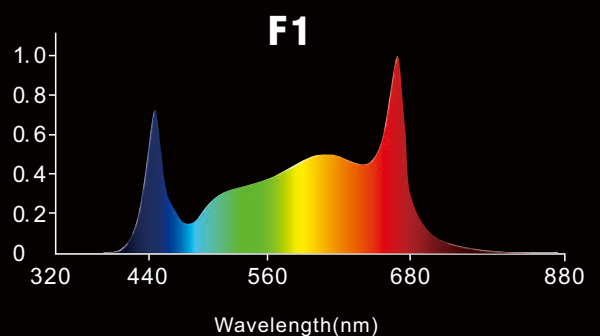
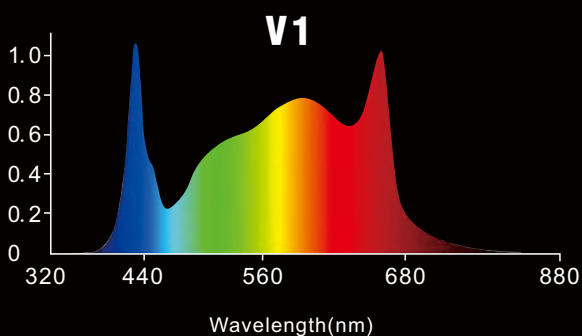

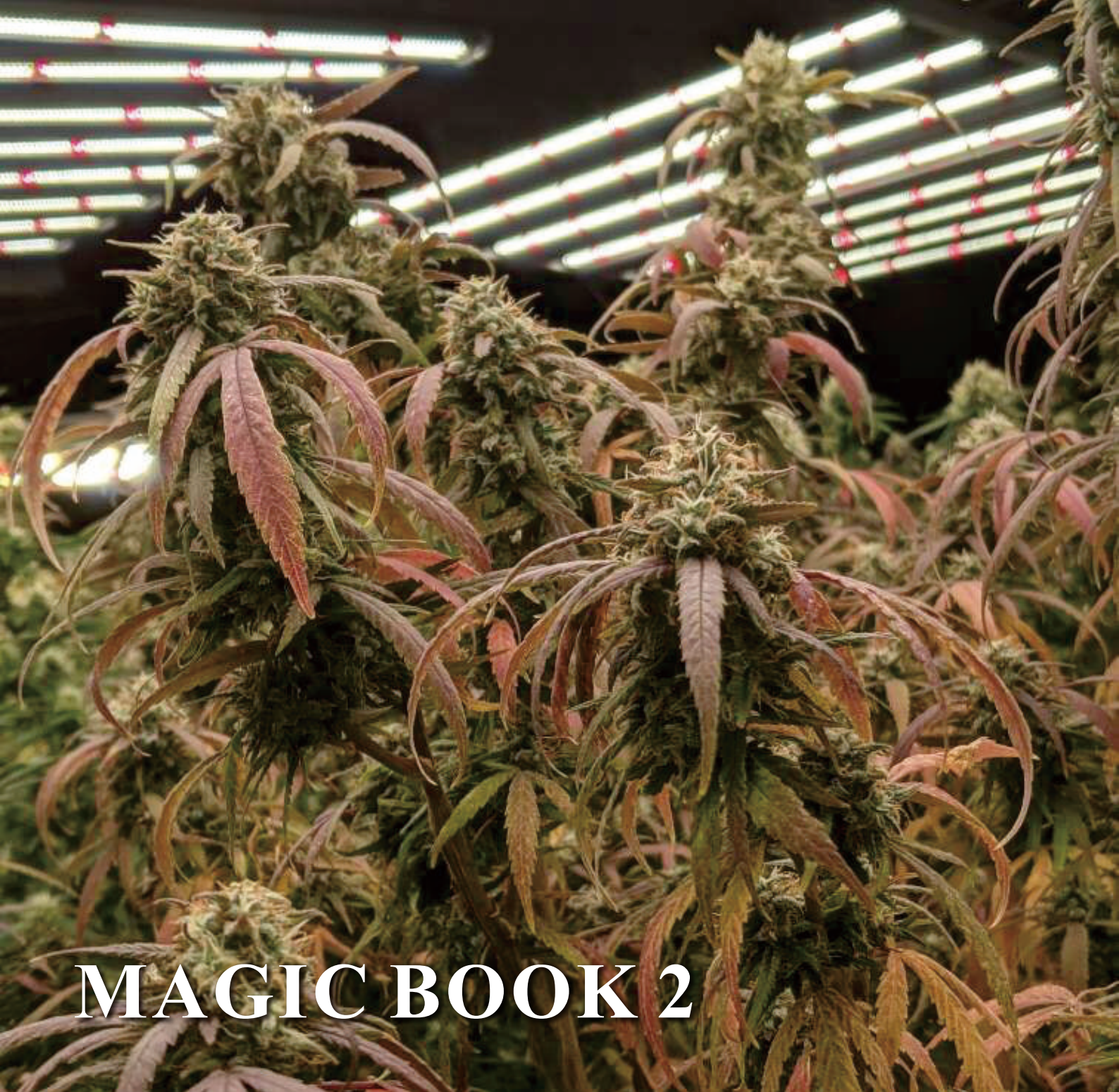

MAGIC BOOK 2

THE MOST POPULAR GROW LIGHT IN THE WORLD

The MB2 is foldable designed full spectrum grow light for indoor cannabis growing from veg to flowering stage. Offering 3-4 levels of PPF light output, it is a highly flexible grow light solution with easy installation for growers.

MAGIC BOOK 2 -720W

FIXTURE SPECIFICATIONS

Light source	Samsung+Osram LEDs
PPF	1872 $\mu\text{mol/s}$
Efficacy	2.6-2.8 $\mu\text{mol/J}$
Input power	720W
Input voltage	AC120-277V,AC347-480V,50/60Hz
Fixture dimensions (L x W x H)	46.46 x 44.88 x 2.76 inch 1180 x 1140 x 70 mm
Net Weight	24.91lbs / 11.3kg
Dimming	0-10V
Thermal management	Passive
Max.Ambient Temperature	95°F/35°C
Total Harmonic Distortion(THD)	<15%
L90	50,000 hours
Certifications	ETL,DLC,CE

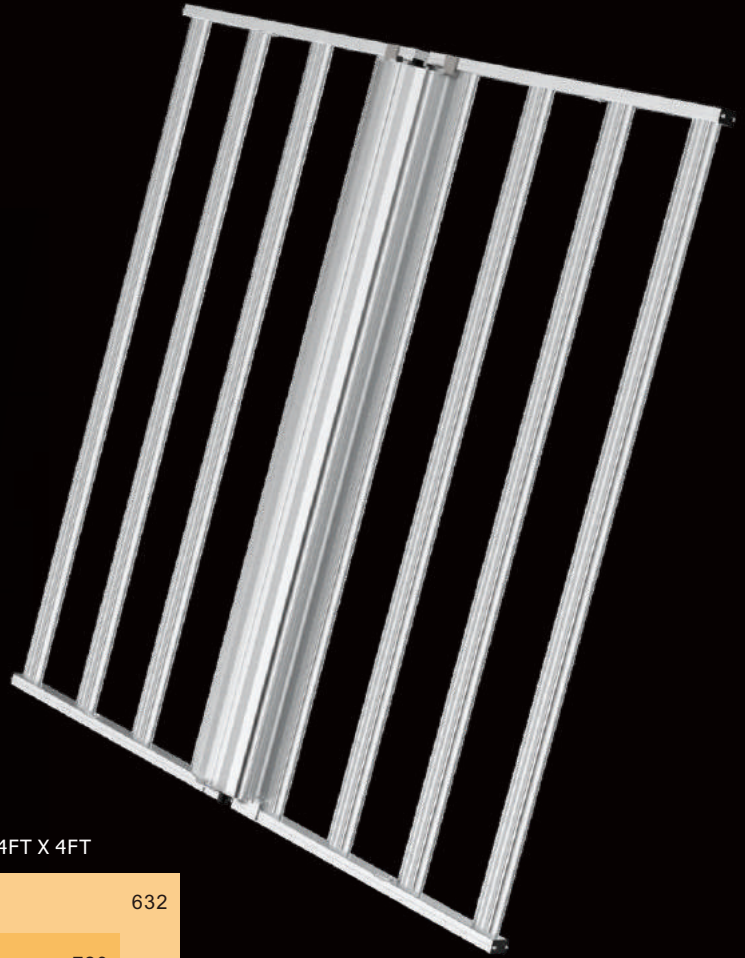

1.2M X 1.2M/4FT X 4FT

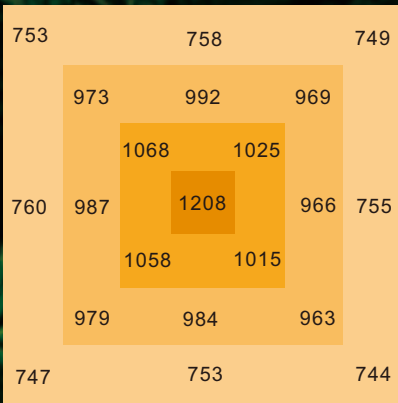

12"/305mm Height
MB2 -720W 2.6 $\mu\text{mol/J}$

1.2M X 1.2M/4FT X 4FT

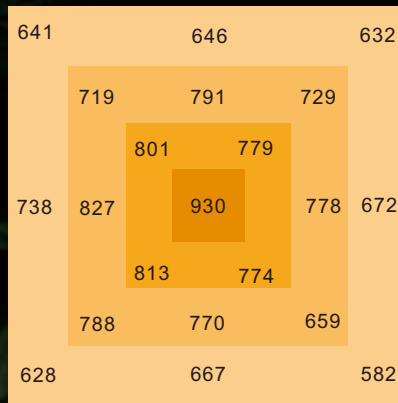

24"/609mm Height
MB2 -720W 2.6 $\mu\text{mol/J}$

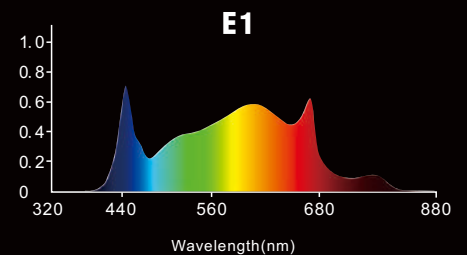
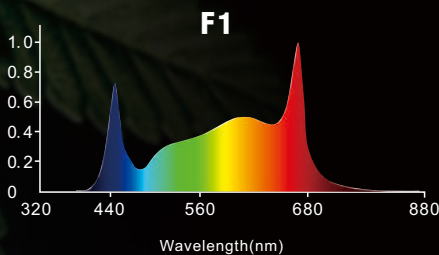
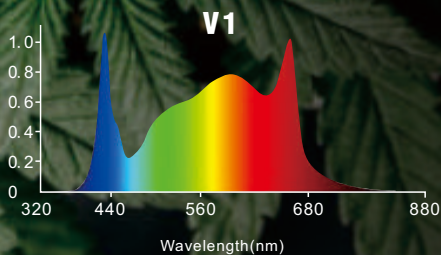



MB2 SLIM

The MB2 slim is foldable designed full spectrum grow light for indoor cannabis growing from veg to flowering stage. with 6 bars, it is an eco version of MB2 grow light.

MB2 SLIM

FIXTURE SPECIFICATIONS

Light source	Samsung+Osram LEDs
PPF	1716 $\mu\text{Mol/s}$
Efficacy	2.6-2.8 $\mu\text{Mol/J}$
Input power	660W
Input voltage	AC120-277V, AC347-480V, 50/60Hz
Fixture dimensions (L x W x H)	44.09 x 42.0 x 2.76 inch 1120 x 1067 x 70 mm
Net Weight	22.05lbs / 10kg
Dimming	0-10V
Thermal management	Passive
Max. Ambient Temperature	95°F/35°C
Total Harmonic Distortion (THD)	<15%
L90	50,000 hours
Certifications	ETL, DLC, CE



1.2M X 1.2M/4FT X 4FT

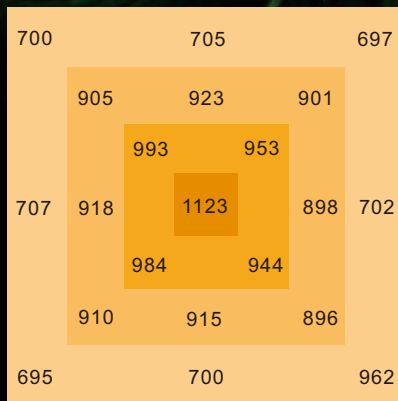

12"/305mm Height
MB2 SLIM-660W 2.6 $\mu\text{Mol/J}$

1.2M X 1.2M/4FT X 4FT

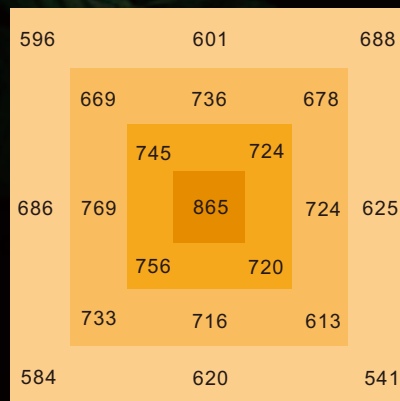

24"/609mm Height
MB2 SLIM-660W 2.6 $\mu\text{Mol/J}$

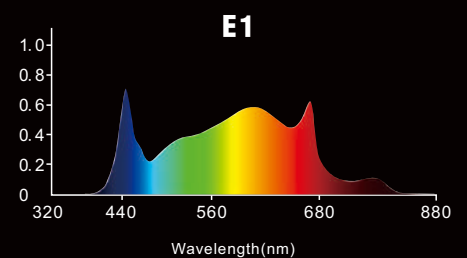
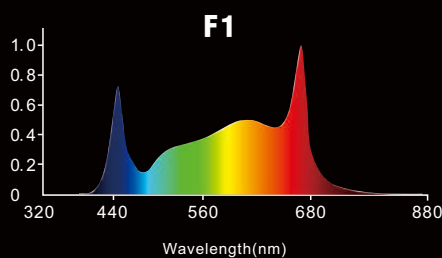
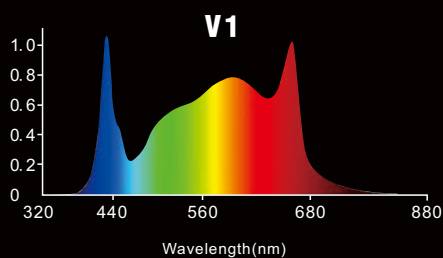



SK2

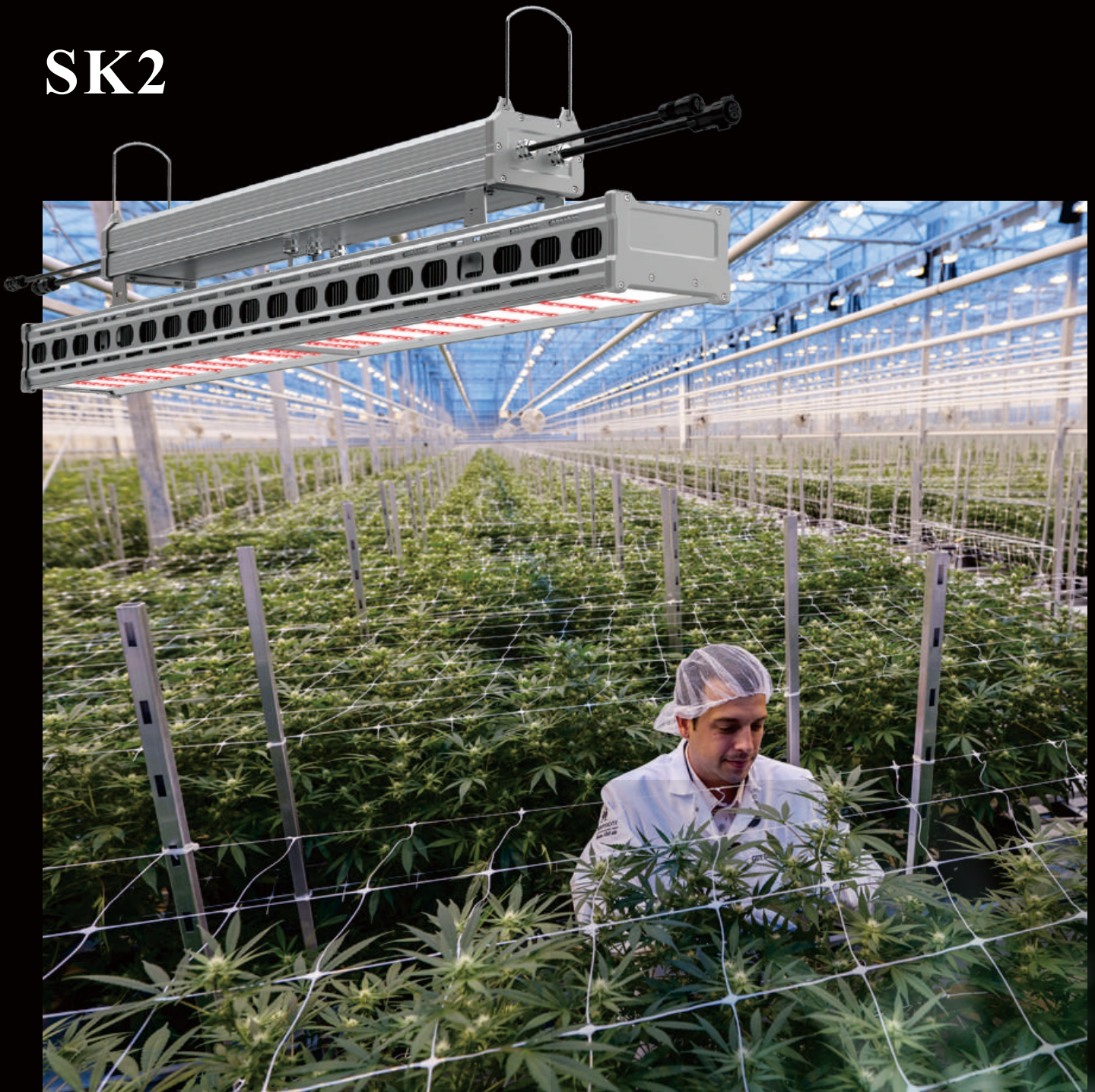

Featuring multiple spectra and high Efficacies.
SK2 is LLWINCS latest top lighting solution for greenhouse supplemental lighting.

SK2



FIXTURE SPECIFICATIONS

Light source	Samsung+Osram LEDs		
PPF	1120 $\mu\text{Mol/s}$	1540 $\mu\text{Mol/s}$	1960 $\mu\text{Mol/s}$
Efficacy	2.6-2.8 $\mu\text{Mol/J}$		
Input power	400W	550W	700W
Input voltage	AC120-277V, AC347-480V, 50/60Hz		
Fixture dimensions (L x W x H)	35.82 x 5.38 x 8.07 inch 910 x 136.7 x 204.9 mm	47.64 x 5.38 x 8.07 inch 1210 x 136.7 x 204.9 mm	59.45 x 5.38 x 8.07 inch 1510 x 136.7 x 204.9 mm
Net Weight	26.4 lbs / 11.99 kg	27.88 lbs / 12.65kg	32.16 lbs / 14.59kg
Dimming	0-10V		
Thermal management	Passive		
Max.Ambient Temperature	95°F/35°C		
Total Harmonic Distortion(THD)	<15%		
L90	50,000 hours		
Certifications	ETL,DLC,CE		

1.2M X 1.2M/4FT X 4FT

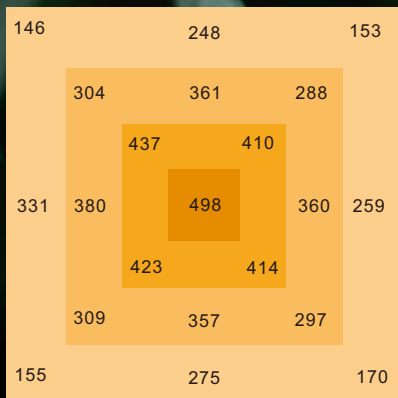

36" /90cm Height
Sk2 -550W 2.6 $\mu\text{Mol/J}$

1.2M X 1.2M/4FT X 4FT

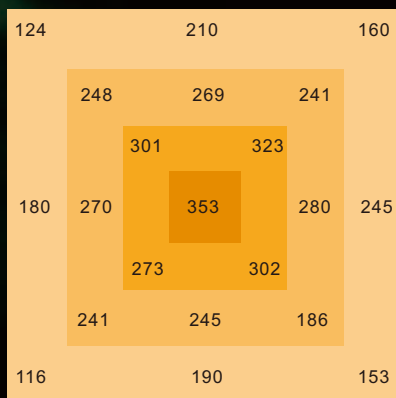

48" /1.2m Height
Sk2 -550W 2.6 $\mu\text{Mol/J}$

1.2M X 1.2M/4FT X 4FT

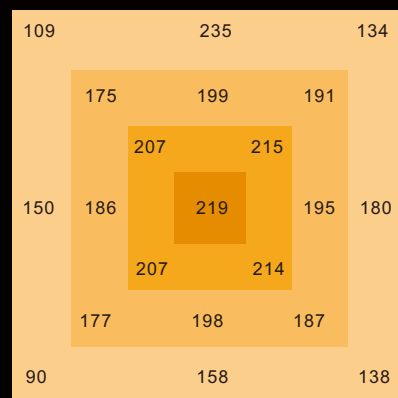

60" /1.5m Height
Sk2 -550W 2.6 $\mu\text{Mol/J}$

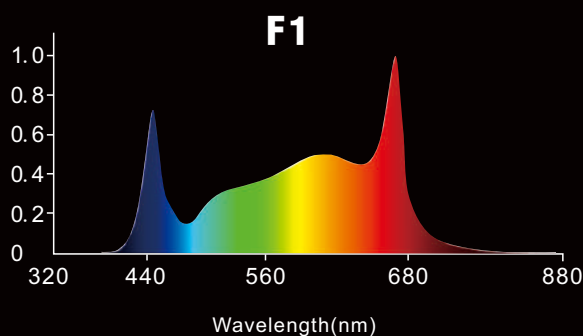
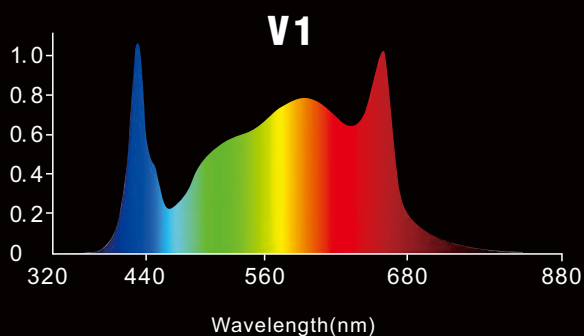

METEOR STORM

un-assembly packaged-save shipping cost
high customizable-Multiple size or watts choice
smart installation-snap in/out



METEOR STORM

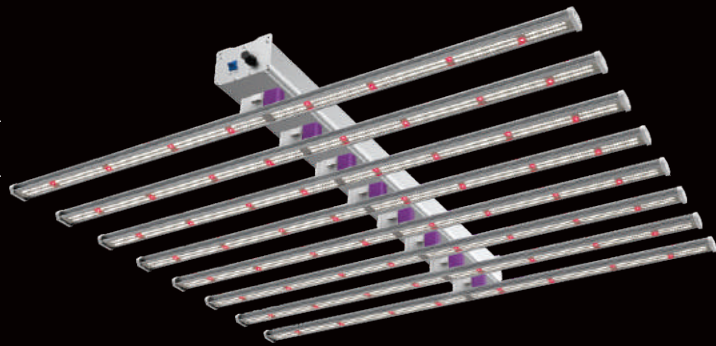

FIXTURE SPECIFICATIONS

	6 bar -700W	8 bar -800W	8bar-1000W
Light source	Samsung+Osram LEDs		
PPF	1820 $\mu\text{Mol/s}$	2080 $\mu\text{Mol/s}$	2600 $\mu\text{Mol/s}$
Efficacy	2.6-2.8 $\mu\text{Mol/J}$		
Input power	700W	800W	1000W
Input voltage	AC120-277V,AC347-480V,50/60Hz		
Fixture dimensions (L x W x H)	45 x 46.96 x 5.34 inch 1068 x 1193 x135.6 mm	45 x 46.96 x 5.34 inch 1068 x 1193 x135.6 mm	45 x46.96 x5.34 inch 1068 x 1193 x135.6 mm
Net Weight	22 lbs / 10kg	27.7 lbs / 12.6kg	30 lbs / 13.6kg
Dimming	0-10V		
Thermal management	Passive		
Max.Ambient Temperature	95°F/35°C		
Total Harmonic Distortion(THD)	<15%		
L90	50,000 hours		
Certifications	ETL,DLC,CE		

1.2M X 1.2M/4FT X 4FT

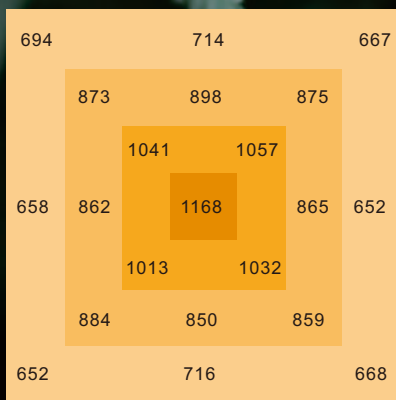

12" /305mm Height
MS6 -700W 2.6 $\mu\text{Mol/J}$

1.2M X 1.2M/4FT X 4FT

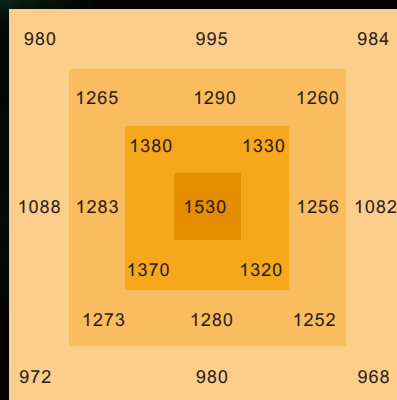

12" /305mm Height
MS8 -800W 2.6 $\mu\text{Mol/J}$

1.2M X 1.2M/4FT X 4FT

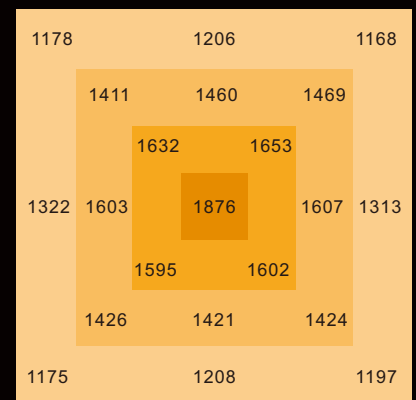

12" /305mm Height
MS8 -1000W 2.6 $\mu\text{Mol/J}$

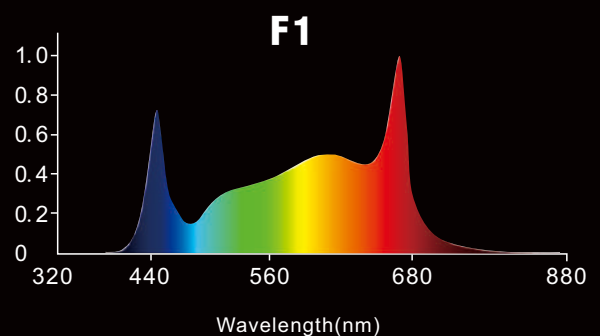
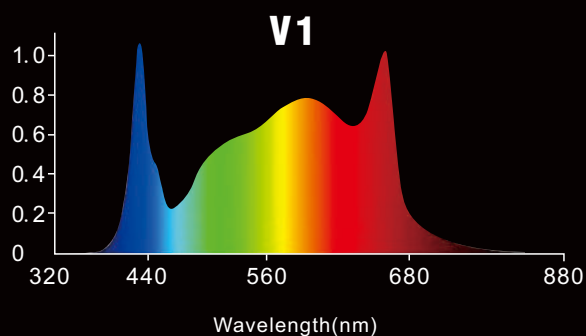

MASTER CONTROLLERS - Gen 2

AUTOMATED MANAGEMENT OF YOUR LED GROW LIGHT ARRAY



Touch screen controller



Max. control up to 100 fixtures



Spectrum Tunable



Automate time scheduling, brightness and spectrums



Independent sunrise/sunset settings



Automatic timer, intensity and spectrum

Overview of Touch screen

