

Date: \_\_\_\_\_ Location: \_\_\_\_\_  
 Product: \_\_\_\_\_ Project: \_\_\_\_\_  
 Quantity: \_\_\_\_\_ Catalog #: \_\_\_\_\_

## LED Multi Watt Multi CCT Troffer Series with Emergency Battery



**2x4**

24W, 29W, 32W and 39W



**2x2**

15W, 19W, 24W and 29W

### FEATURES

- Default Wattage is the highest wattage
  - 2x4 – 39W
  - 2x2 – 29W
- Default CCT: 5,000K
- Glare-free lighting
- 100,000 hours lifetime

### SUITABLE APPLICATIONS

- Warehouses
- Schools
- Factories
- Offices
- Supermarkets
- Logistic Centers
- Exhibition Halls

#### CONSTRUCTION:

Steel and Aluminum frame. Matte white finish. The entire fixture functions as a heat sink to keep the LEDs cooler to prolong the life of the light.

#### OPTICAL SYSTEM:

Samsung 2835 LED chips. 120° beam angle.

#### WARRANTY:

5-year limited warranty. Actual performance may differ as a result of end-user environment and application.

#### ELECTRICAL:

120-277V input standard.  
 -20°C to 50°C, -4°F to 122°F

#### INSTALLATION & MOUNTING:

Fits most preexisting troffers. Surface mount kit and recessed kit.

#### CONTROLS & DIMMING:

0-10V dimming comes standard. Suitable for use with LED dimmers.



MODEL NUMBER – 3,500K, 4,000K and 5,000K	SIZE	WATTAGE	LUMENS	EFFICACY	CRI	POWER FACTOR	THD	REPLACES
LOC-22TROF-DMWMCCT-EM	2x2	15W	2,109.75LM	140.65LM/W	82.1	0.9771	10.6%	150W HID
LOC-22TROF-DMWMCCT-EM	2x2	19W	2,672.35LM	140.65LM/W				150W HID
LOC-22TROF-DMWMCCT-EM	2x2	24W	3,375.6LM	140.65LM/W				150W HID
LOC-22TROF-DMWMCCT-EM	2x2	29W	4,078.1LM	140.65LM/W				150W HID
LOC-24TROF-DMWMCCT-EM	2x4	24W	3,262.32LM	135.93LM/W	82.6	0.9637	7.12%	200W HID
LOC-24TROF-DMWMCCT-EM	2x4	29W	3,941.97LM	135.93LM/W				200W HID
LOC-24TROF-DMWMCCT-EM	2x4	32W	4,349.76LM	135.93LM/W				200W HID
LOC-24TROF-DMWMCCT-EM	2x4	39W	5,296.5LM	135.93LM/W				200W HID

Series	Size	Dimming	2x2 Wattage	2x4 Wattage	Color Temperature	Accessory
LOC-TROF	22 = 2x2 24 = 2x4	D = Dimmable	15W 19W 24W 29W	24W 29W 32W 39W	3500K 4000K 5000K	EM = emergency backup

## MEASUREMENTS

2x2

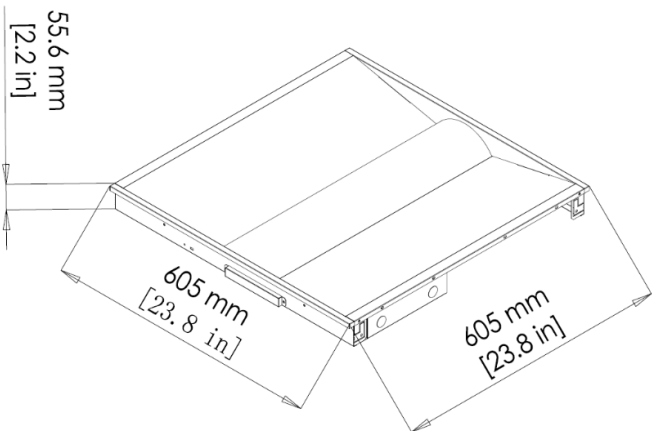

2x4

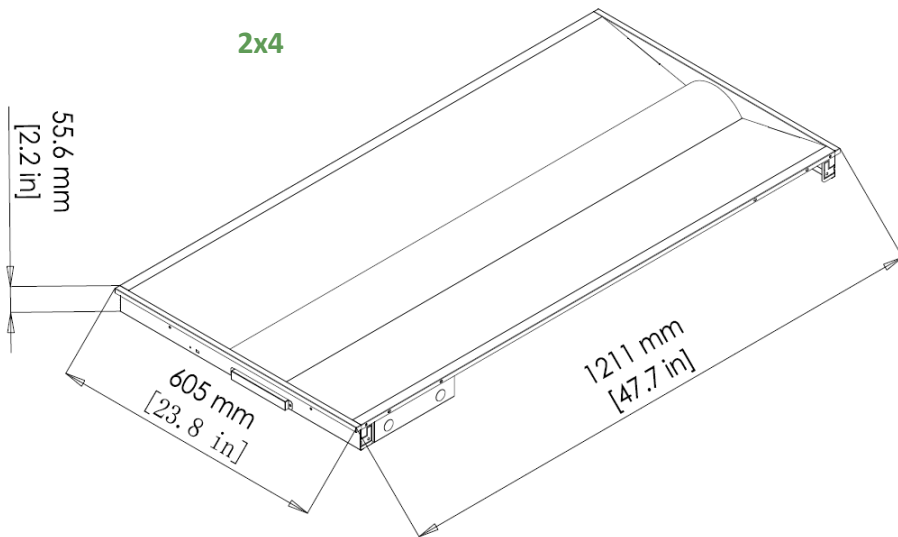

MODEL	QUANTITY	WEIGHT	UPC CODE
LOC-22TROF-DMWMCCT	1	lbs	00810050940726
LOC-24TROF-DMWMCCT	1	lbs	00810050940719

### 15W Emergency Battery

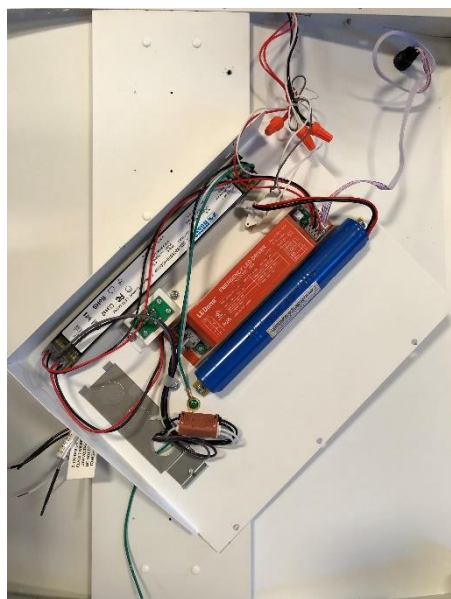

### Emergency Test Button



## 2x2 15W

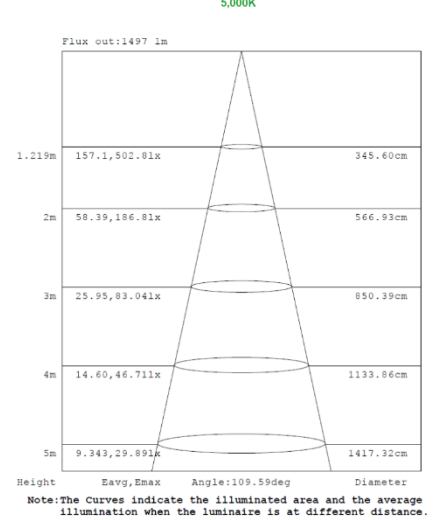
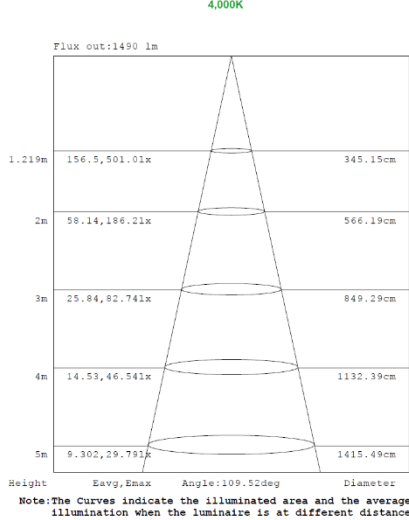
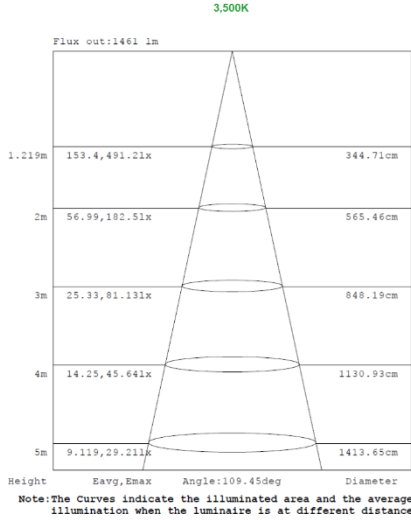
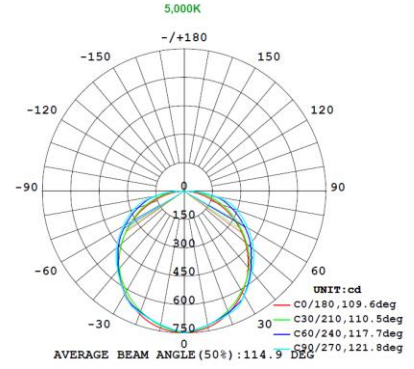
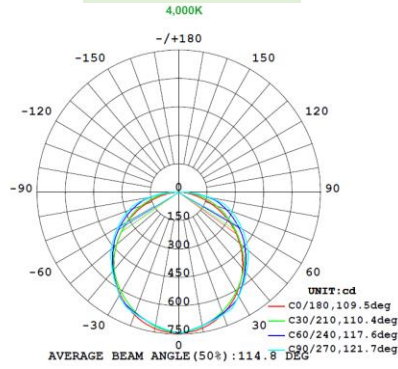
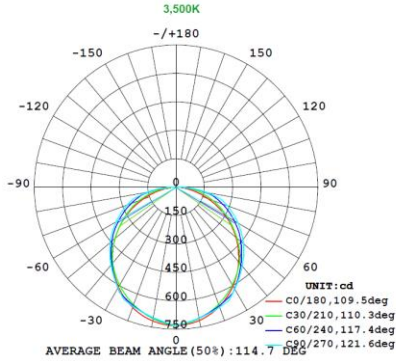

## 2x2 19W

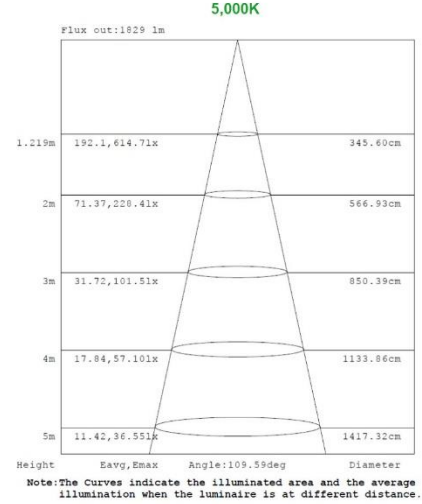
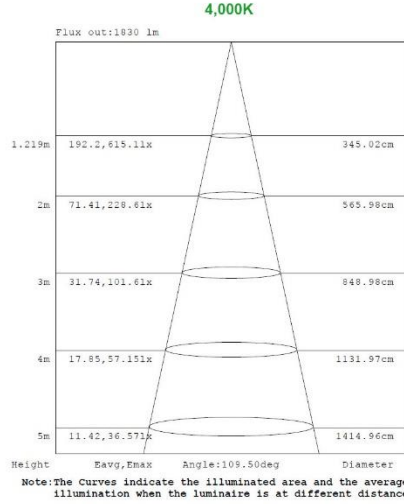
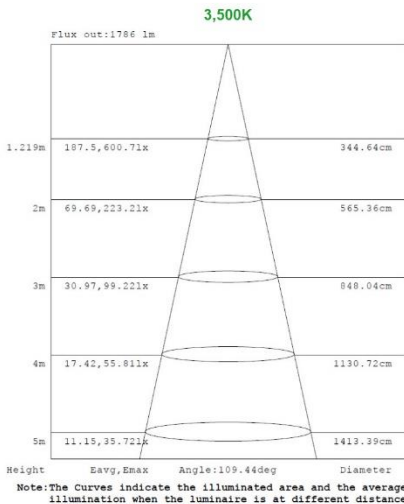
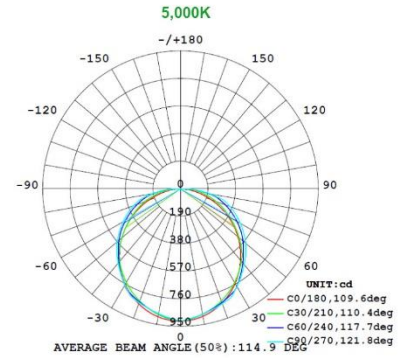
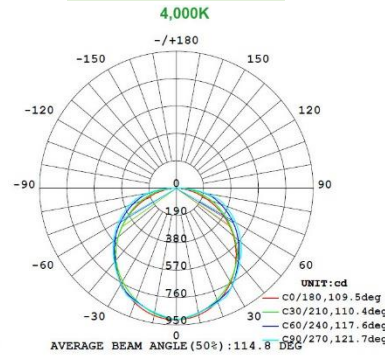
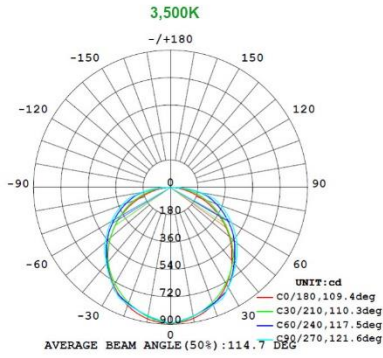

## 2x2 24W

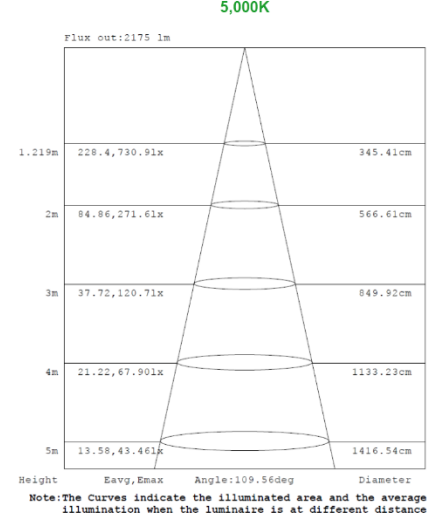
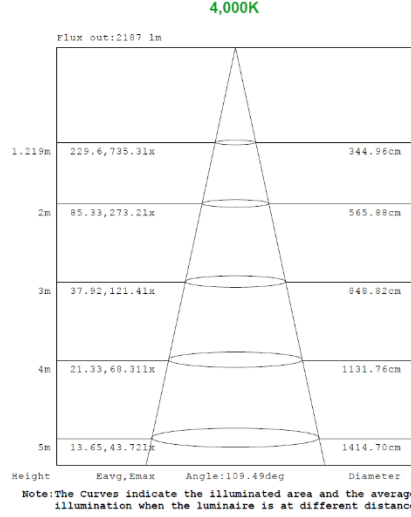
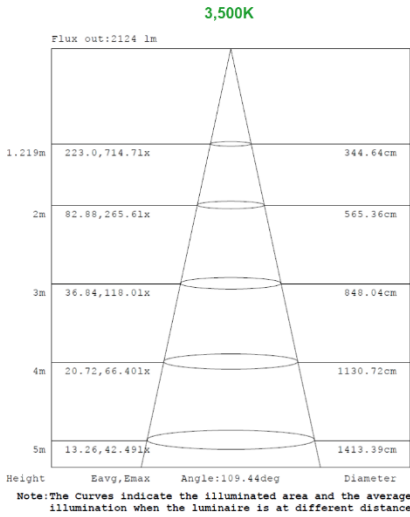
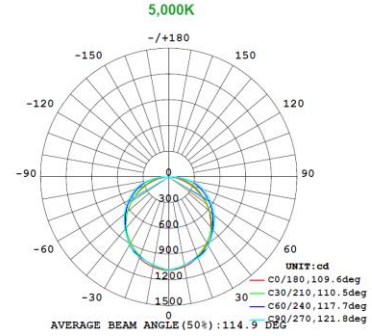
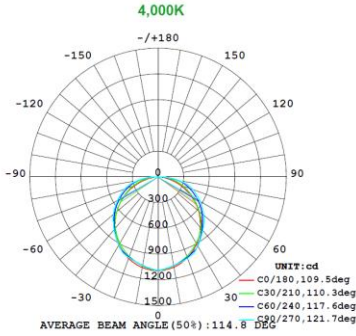
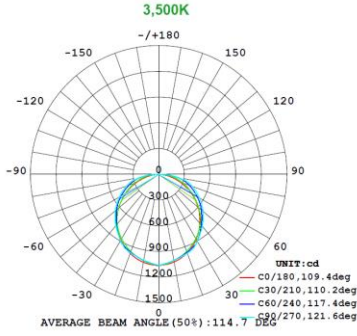

## 2x2 29W

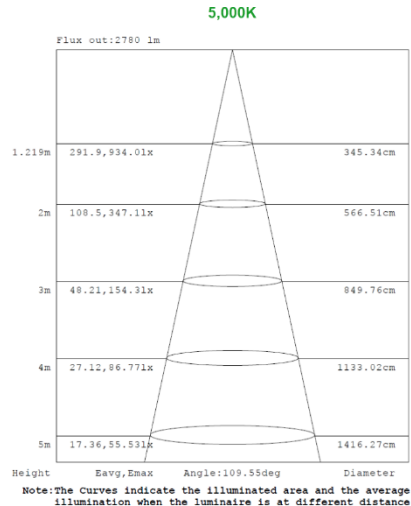
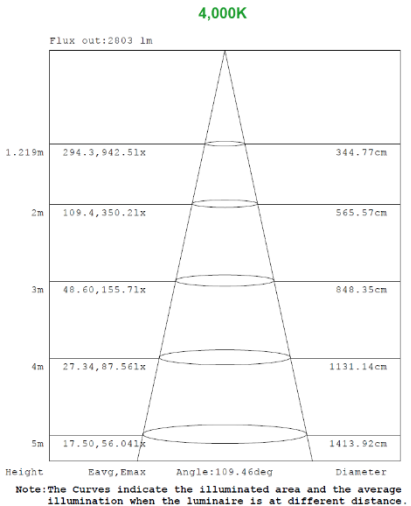
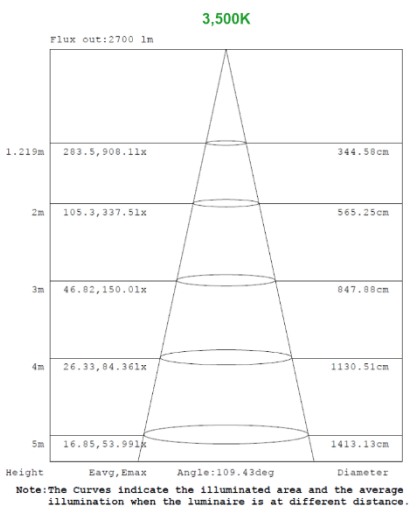
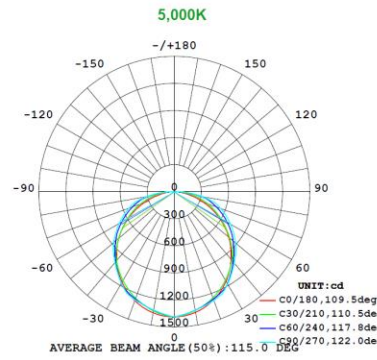
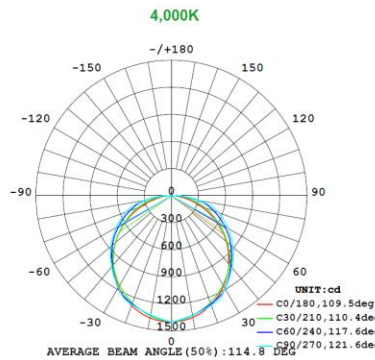
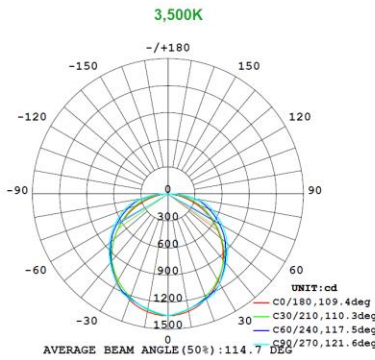

## 2x4 24W

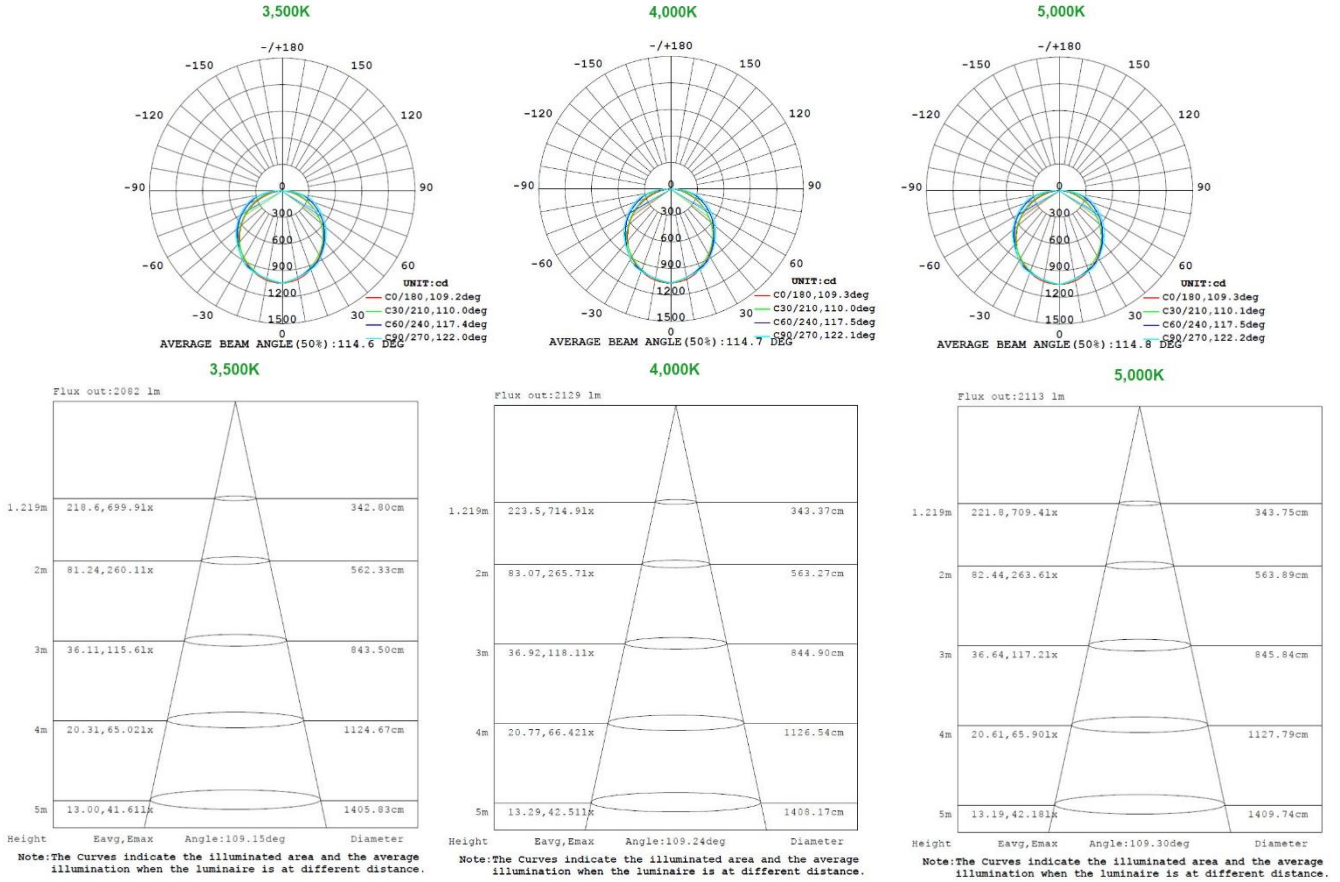

## 2x4 29W

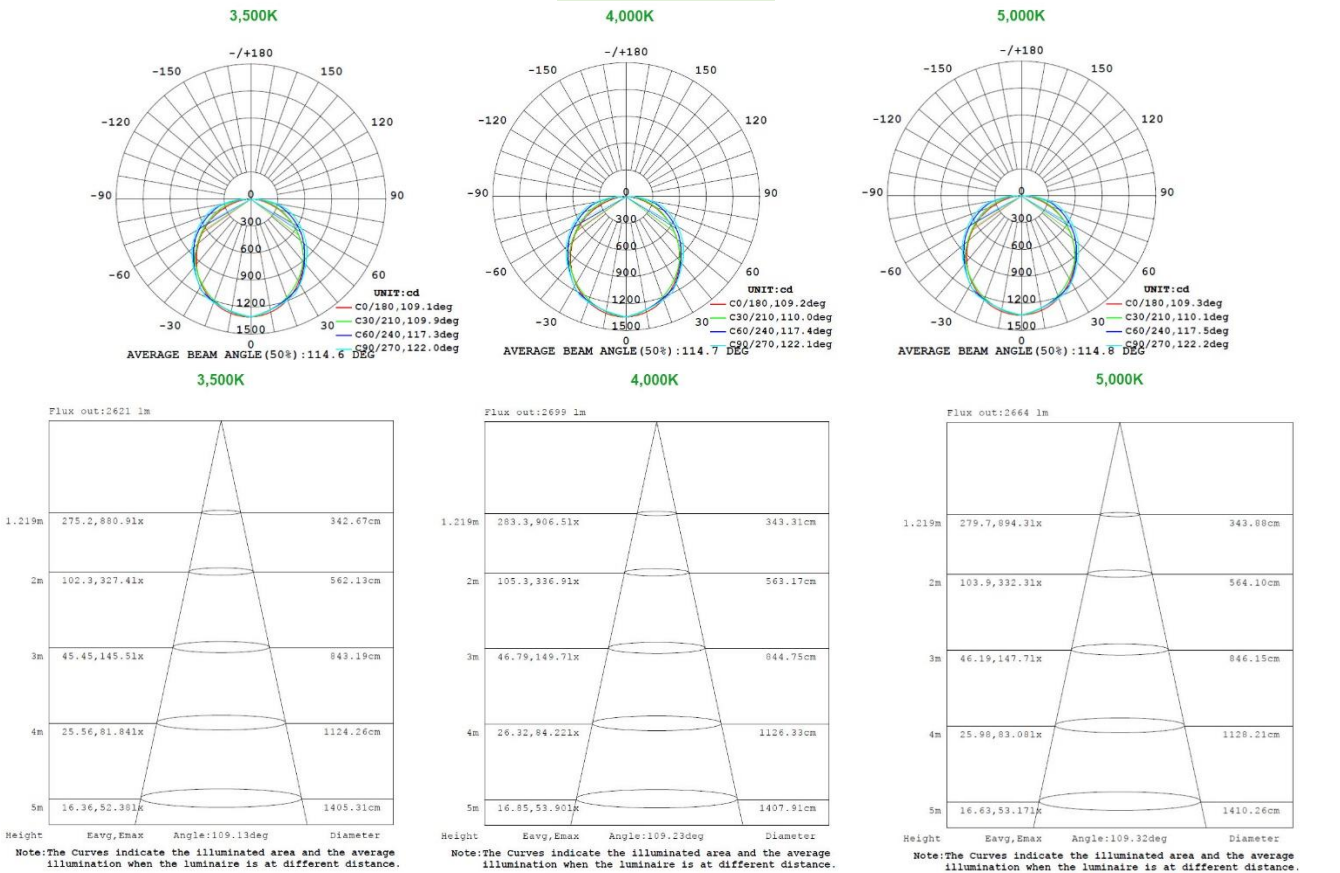

## 2x4 32W

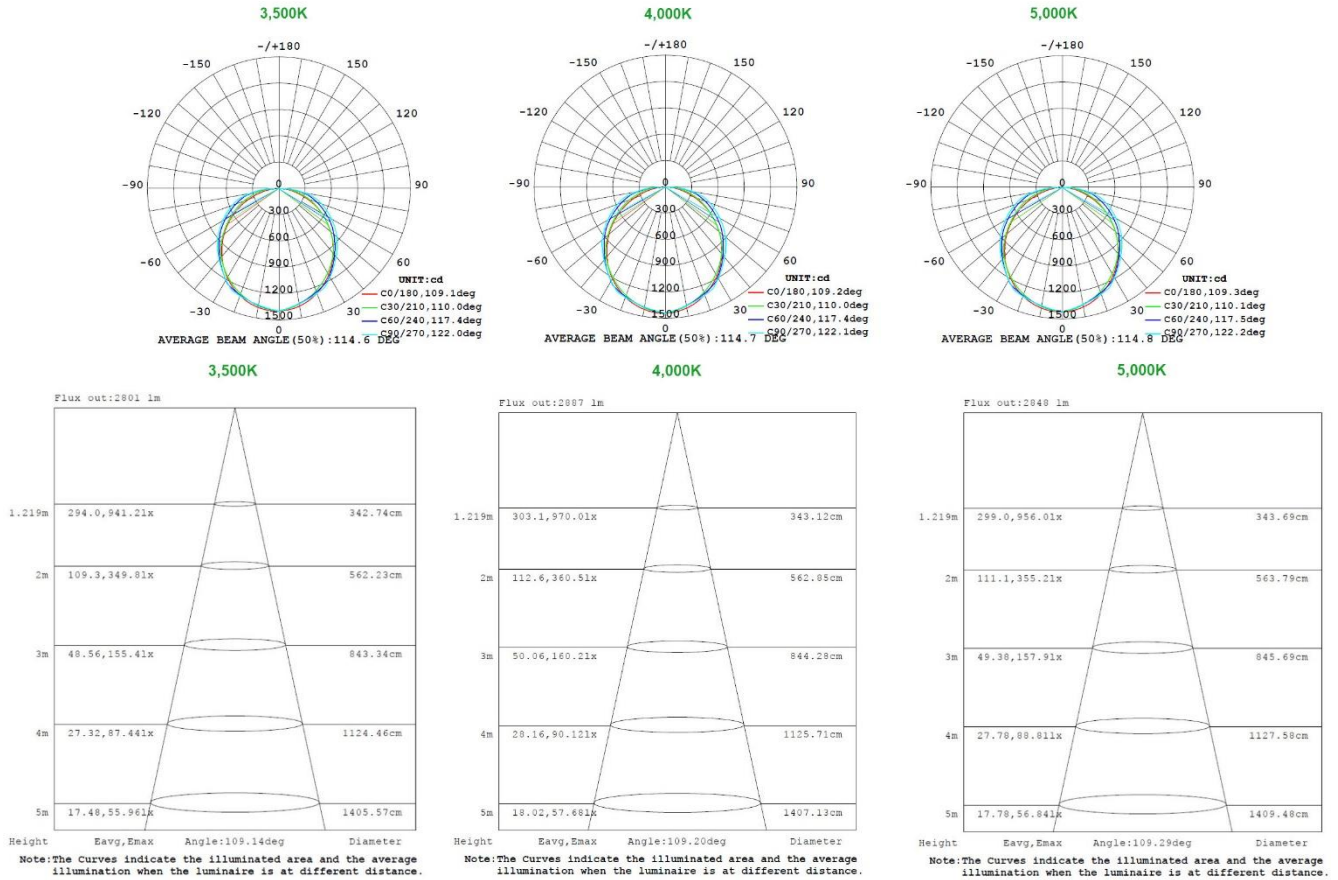

## 2x4 39W

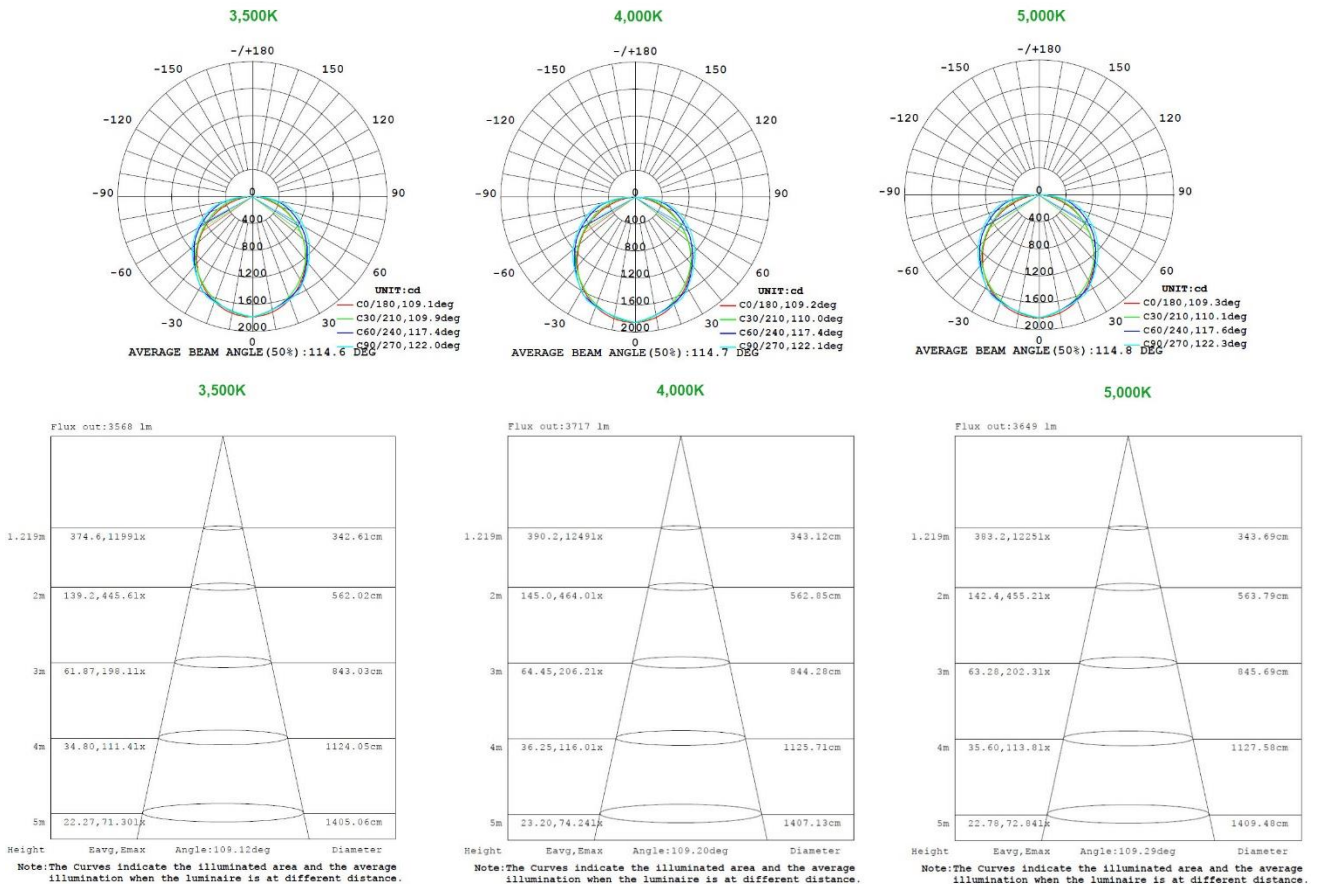

# MOUNTING OPTIONS

Surface Mount

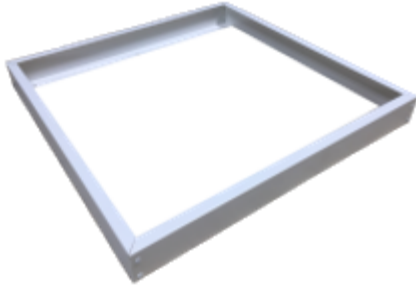

Recessed Mount

