

Date: _____ Location: _____
 Product: _____ Project: _____
 Quantity: _____ Catalog #: _____

LED LOC-SL Multi Watt Multi CCT Strip Light with Emergency Battery and Motion Sensor



FEATURES

- Default Wattage is the highest wattage:
 - 4 Foot – 44W
- Default CCT: 5,000K
- IP20 rated
- Linkable design (see page 2 for details)
- 50,000 hours lifetime

SUITABLE APPLICATIONS

- Stairwells
- Warehouses
- Stadiums
- Factories
- Parking Lots
- Shopping Malls
- Supermarkets
- Logistic Centers
- Auto dealerships

CONSTRUCTION:

22-gauge metal housing with matte white paint. PMMA cover lens. Frosted lens. PC endcaps, quick-connector adaptor for continuous-run mounting.

OPTICAL SYSTEM:

Seoul 2835 LED chips. High quality tempered glass optics. 120° beam angle.

WARRANTY:

5-year limited warranty. Actual performance may differ as a result of end-user environment and application.

ELECTRICAL:

Available as 120-277V input. -20°C to 50°C, -4°F to 122°F

INSTALLATION & MOUNTING:

Hanging chain, surface mount or J-adaptor. These can link together. See above features for how many.

CONTROLS & DIMMING:

0-10V dimming comes standard.



MODEL NUMBER – 3,500K 4,000K 5,000K	WATTAGE	LUMENS	EFFICACY	CRI	POWER FACTOR	THD	REPLACES
LOC-4FTSL-MW(22/28/36/44)MCCT(35/40/50)DF-EM-MS	22W	2,862.2LM	130.1LM/W	80	0.9	20%	2 pieces 17W T8 lamp or 2 pieces 32W T8 lamp
LOC-4FTSL-MW(22/28/36/44)MCCT(35/40/50)DF-EM-MS	28W	3,642.8LM	130.1LM/W	80	0.9	20%	2 pieces 17W T8 lamp or 2 pieces 32W T8 lamp
LOC-4FTSL-MW(22/28/36/44)MCCT(35/40/50)DF-EM-MS	36W	4,683.6LM	130.1LM/W	80	0.9	20%	2 pieces 17W T8 lamp or 2 pieces 32W T8 lamp
LOC-4FTSL-MW(22/28/36/44)MCCT(35/40/50)DF-EM-MS	44W	5,726.9LM	129.77LMW	84	0.9739	6.82%	2 pieces 17W T8 lamp or 2 pieces 32W T8 lamp

Series	Size	4FT Wattage	Color Temperature	Dimming	Material	Accessory
LOC-SL	4FT = 4 foot	22W 28W 36W 44W	3500K 4000K 5000K	Dimmable	F = Frosted Lens	EM = emergency backup MS = motion sensor

MEASUREMENTS

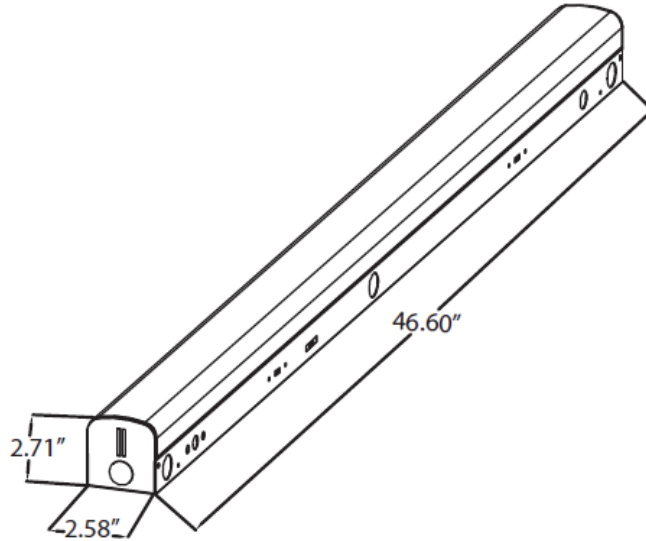

MODEL	QUANTITY	WEIGHT	UPC CODE
LOC-4FTSL-MW(22/28/36/44)MCCT(35/40/50)DF-EM-MS	1	lbs	00810050941624

LINKING TOGETHER

Model Number	Voltage (18AWG)	Linkable Qty	Voltage (16AWG)	Linkable Qty
LOC-4FTSL-MW(22/28/36/44)MCCT(35/40/50)DF-EM	120V	20	120V	30
	240V	40	240V	65
	277V	50	277V	75

Emergency Battery



Emergency Test Button



4FT 22W

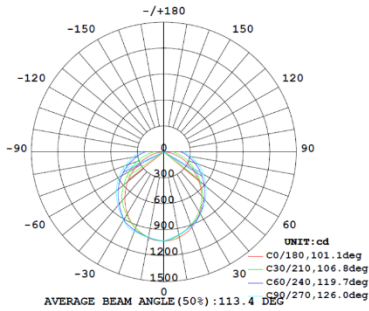

3,500K

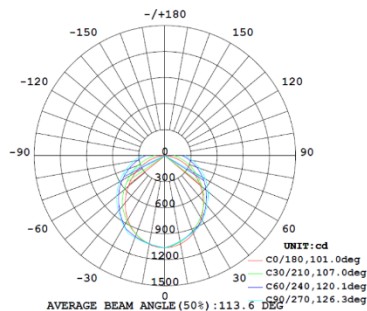

4,000K

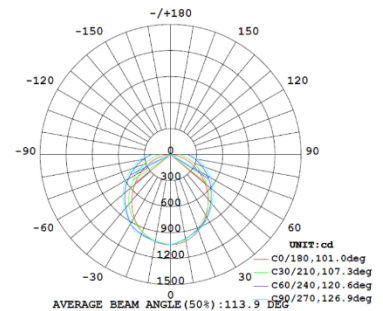

5,000K

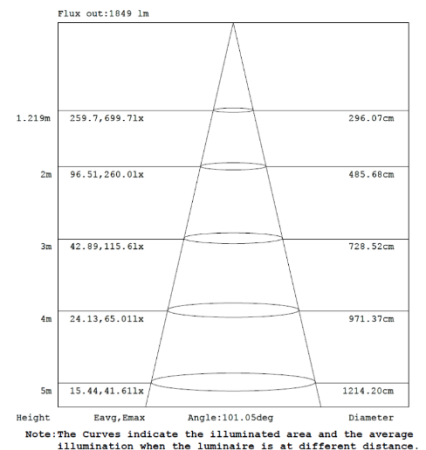
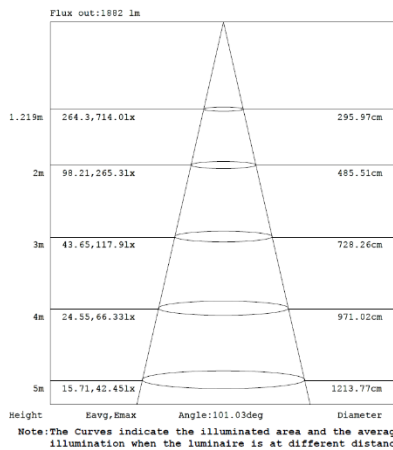
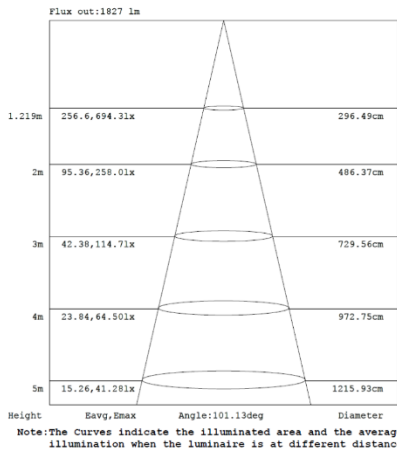

4FT 28W

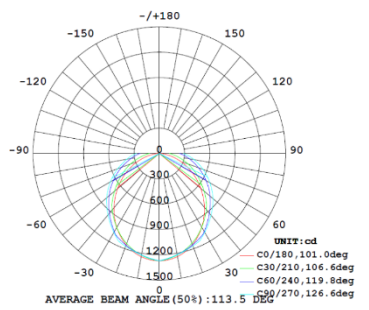

3,500K

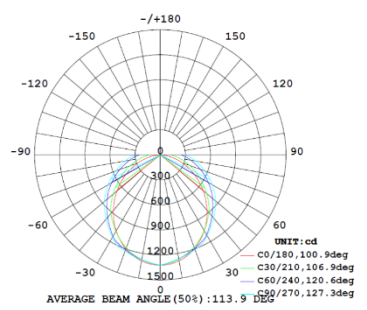

4,000K

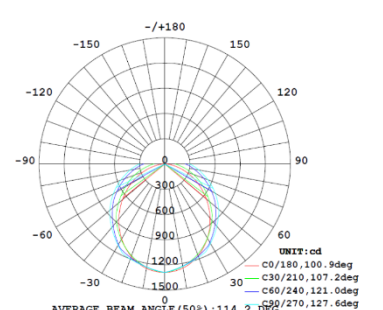

5,000K

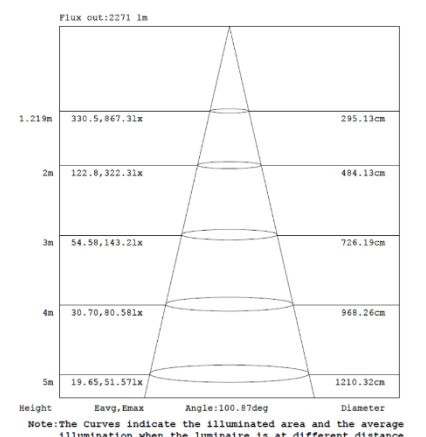
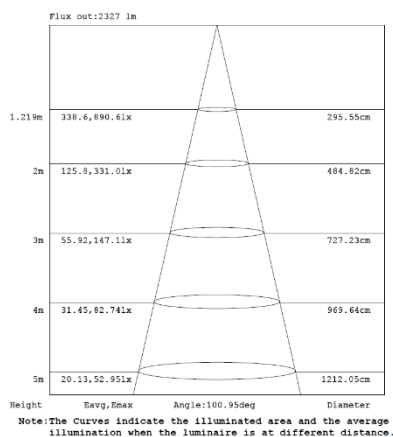
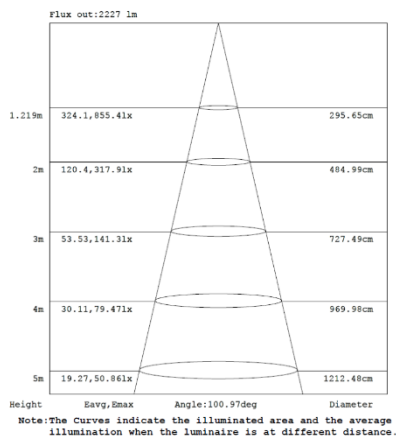

PHOTOMETRIC DATA

4FT 36W

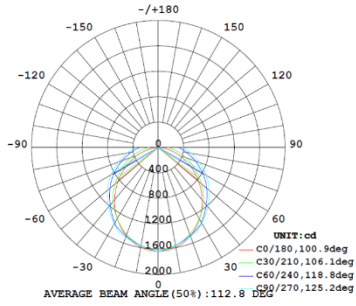

3,500K

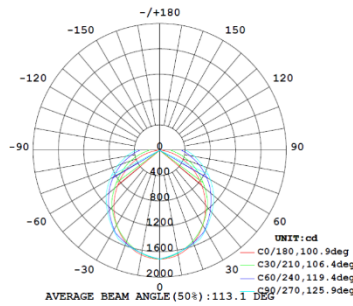

4,000K

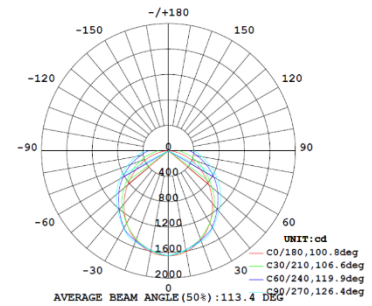

5,000K

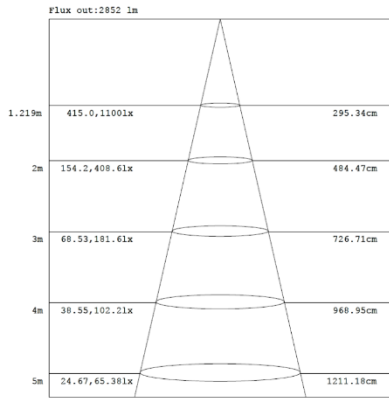

Note: The Curves indicate the illuminated area and the average illumination when the luminaire is at different distance.

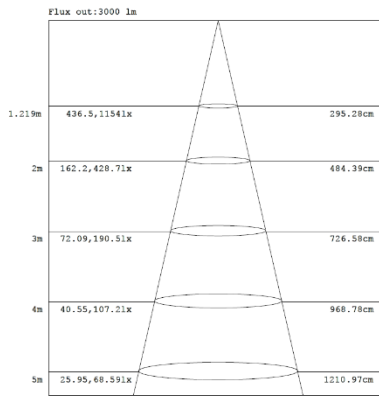

Note: The Curves indicate the illuminated area and the average illumination when the luminaire is at different distance.

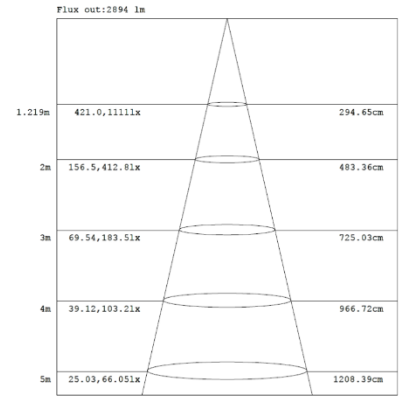

Note: The Curves indicate the illuminated area and the average illumination when the luminaire is at different distance.

4FT 44W

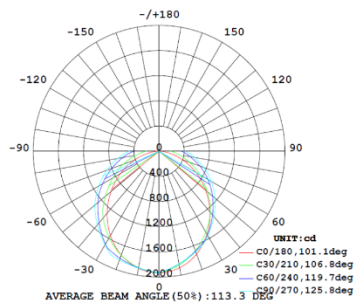

3,500K

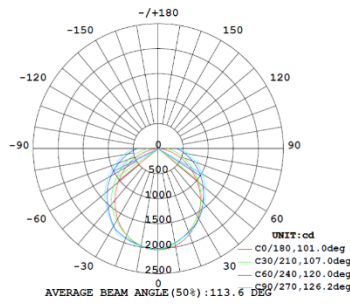

4,000K

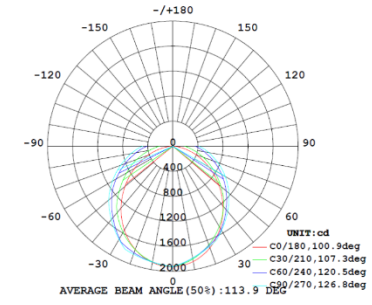

5,000K

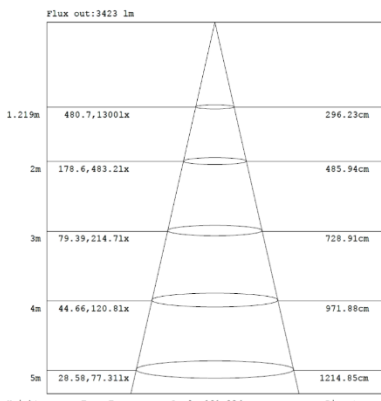

Note: The Curves indicate the illuminated area and the average illumination when the luminaire is at different distance.

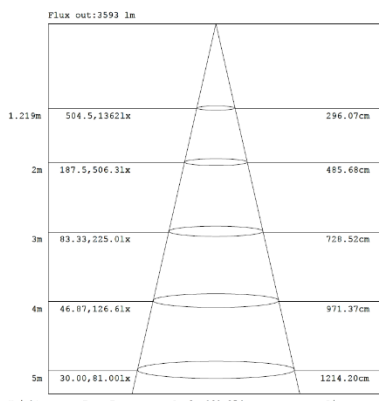

Note: The Curves indicate the illuminated area and the average illumination when the luminaire is at different distance.

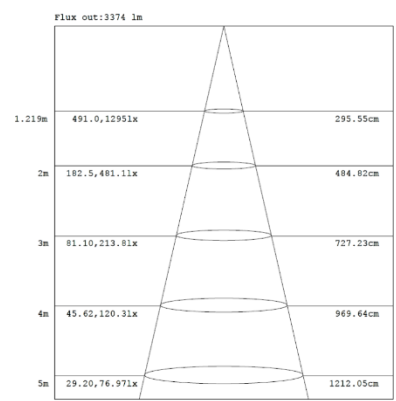

Note: The Curves indicate the illuminated area and the average illumination when the luminaire is at different distance.

OPTIONAL MOUNTING & ACCESSORIES

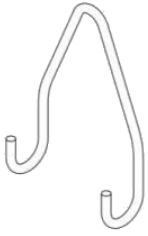

V-Hook (included)



Aircraft Cable



J-Box Cover (included)



Sensor



Remote Control
LOC-RC-100

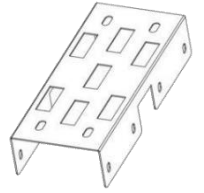

Bracket for linking
together (included)