

LFX-LG SERIES Outdoor Lighting

LFX-LG-50-150W-30K
LFX-LG-50-150W-40K
LFX-LG-50-150W-50K

WESTGATE
THE FUTURE IS HERE...AND IT'S QUITE BRIGHT!

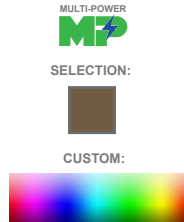

Customer Name: _____
Project Name: _____
Note: _____ | Type: _____

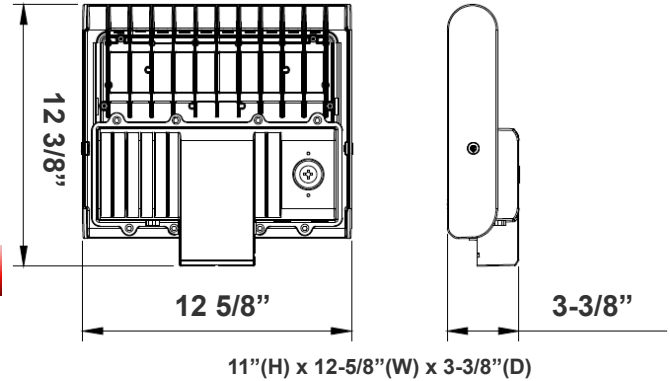

Ideal for general site lighting, alleys, loading docks, doorway, pathway, and parking areas.

Features

- DLC Premium & LED High-Lumen Flood lights
- Solid State Lighting Technology for Long Life
- No Maintenance Needed and High-Efficiency
- 70,000 Hours Rated Life
- 7-Year Warranty
- Optic Lens Type: III
- Multi-Power - The Switch is On the Bottom of the Fixture

Technical Specifications

Electrical:

- Voltage: 120~277V AC/50~60 Hz
- Wattage: 50/ 80/ 100/ 150W
- Power Factor: >0.9
- Efficacy: 135 LPW

Mechanical:

- With Snap-on & Bolt Mounting Options for One- Person Installations. Select a Mounting Option (Sold Separately)
- LED: Philips Lumileds Luxeon 2835 High Flux LED
- Die-cast Aluminum Housing with Powder Coat Finish (Dark Bronze)
- IP Rating: IP65
- Effective Projected Areas (EPA's) are: Front = 0.38 ft², Side = 0.30 ft², Face = 1.05 ft²
- Operating Temperature: -40°F to 104°F
- Suitable for Wet Locations

Lighting:

- Dimming: 0~10V dimmable
- Optic Lens Type: III
- Cord Type: 6' SJTW 18/3 AWG cable
- Total Lumens: 21400LM Max.
- Color Temperature: 3000K/ 4000K/ 5000K
- Color Rendering Index: ≥ 82
- Beam Angle: 120°X 90°

Applications:

- Ideal for general site lighting, alleys, loading docks, doorway, pathway and parking areas.
- Replace existing HID flood lights/ wall packs

Other Models:

- 300W | 44000LM | LFX-XL-150-300W-30K
- 300W | 44000LM | LFX-XL-150-300W-40K
- 300W | 44000LM | LFX-XL-150-300W-50K



Phone: (877) 805-2252 | Fax: (877) 805-2252
www.westgatemfg.com | www.westgatecontrols.co



Photometrics: LFX-LG-50-150W

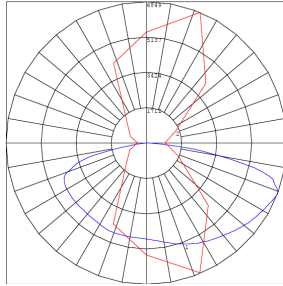
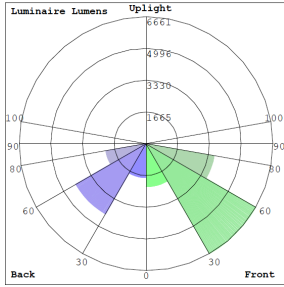

BUG Rating: B3-U0-G3

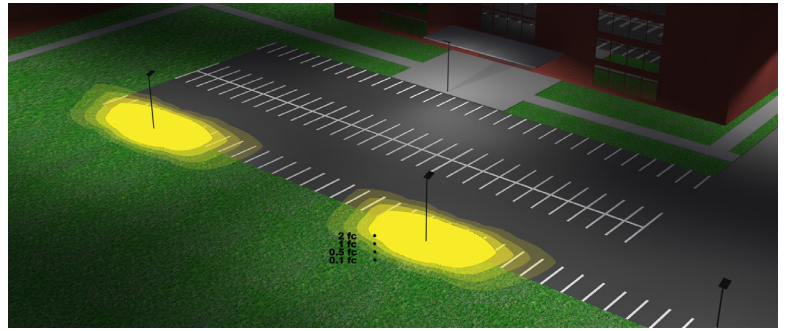

Area 55'x 100' Mounting Height: 20'

Other Views:



Side View



Front View



Back View

Performance Table: LFX-LG-50-150W

MODEL NO.	Wattage	Voltage	Lumens	Color Temp.	BUG Rating	LPW
LFX-LG-50-150W-30K	50W	120~277V	8500LM	3000K 4000K 5000K	B3-U0-G3	135
			8750LM			
			8850LM			
LFX-LG-50-150W-40K	80W		12900LM			
			13200LM			
			13400LM			
LFX-LG-50-150W-50K	100W		15500LM			
			16000LM			
			16150LM			
LFX-LG-50-150W-50K	150W	20850LM				
		21300LM				
		21400LM				

Example:

1. LFX-LG-50-150W-50K

(For LFX 150W 5000K fixture 120-277V)

2. LFX-LG-50-150W-50K
WEC-8RC

(For LFX 150W 5000K fixture 120-277V)
(For Remote Control)

3. LFX-LG-50-150W-50K
WEC-8RC
OPT-SEN-3MR-3

(For LFX 150W 5000K fixture 120-277V)
(For Remote Control)
(For Programmable Microwave BI-Level Motion Sensor)

WESTGATE

Phone: (877) 805-2252 | Fax: (877) 805-2252
www.westgatemfg.com | www.westgatecontrols.co



Sample Ordering

Model Size Min.Wattage Max.Wattage Color Temp.

LFX - LG - 50 - 150W -

30K = 3000K
40K = 4000K
50K = 5000K

Accessories Options

Blank = No Option for Accessories
WEC-8RC = Remote Control for OPT-SEN-3MR-4
*REFER TO PAGE 3 FOR MOUNTING OPTIONS

Factory Installed Options

Blank = No Factory Installed Options
OPT-LF3-PCK = Twist Lock Photocell
OPT-SEN-3MR-3 = Programmable Microwave Bi-Level
OPT-TLSOC7P = 7-Pin Receptacle Kit to accept Smart Control Twist-Lock Photocell (Photocell not incl.) (Shorting Cap incl.)
OPT-CLR-95 = Color Paint

SENSOR AND REMOTE CONTROL OPTIONS



LF3-HL-PCK
Twist-Lock
Photocell + Receptacle Kit



OPT-SEN-3MR-3
Bi-Level Motion
Sensor



WEC-8RC
Remote control



OPT-TLSOC7P
Smart Control
7-Pin Receptacle Kit
(Photocell not incl.)
(Shorting Cap incl.)



Smart Control
7-Pin Receptacle Kit
for
OPT-TLSOC7P

Mounting Options:

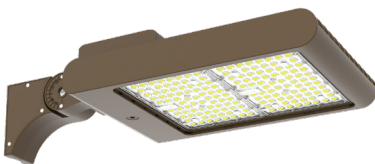

LFX-ASA
Adjustable Straight Arm
3 1/3" x 7 7/8"

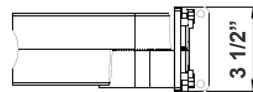
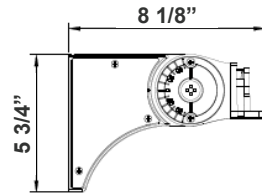

LFX-YK
Yoke
5 3/4" x 6" x 2"

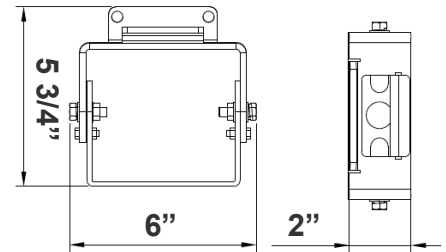

LFX-EXT
Straight Arm
3 1/3" x 6 3/4" x 4 3/8"

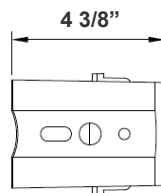
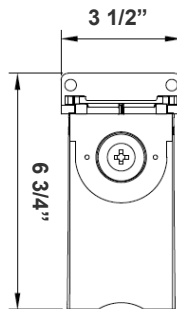

LFX-TR-A
U Bracket
13 3/8" x 10 1/8"

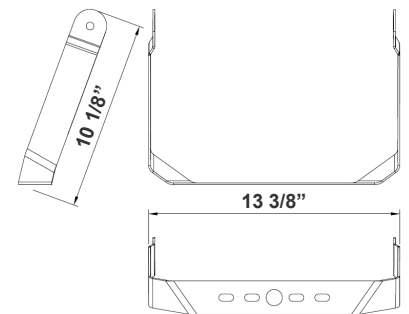

LFX-SF
Slip Fitter
3 1/3" x 7 7/8"

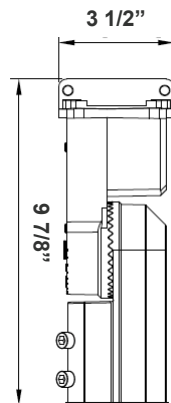

LFX-SF + LFX-PASF
Pole Adapter for Slip Fitter
6 1/8" x 3 1/4" x 3"

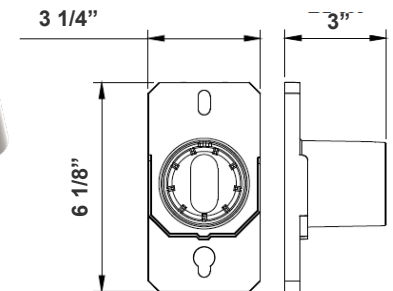

Color Options: LFX-LG-50-150W
 Custom Color Available

Black Silver White **Dark Bronze** Green Red Yellow
 Default color



Shroud & Wire Guard: LFX-LG-50-150W



LF-SHROUD-A
 Shroud
 6 1/8" x 10 5/8" x 4 3/4"

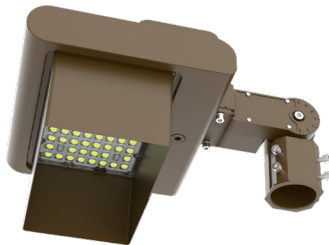
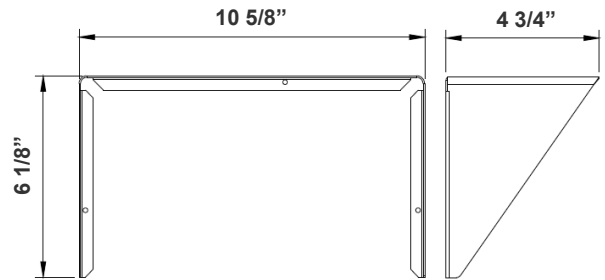

LF-SHROUD-D
 Full-Glare Shroud
 6 1/4" x 10 5/8" x 4 3/4"

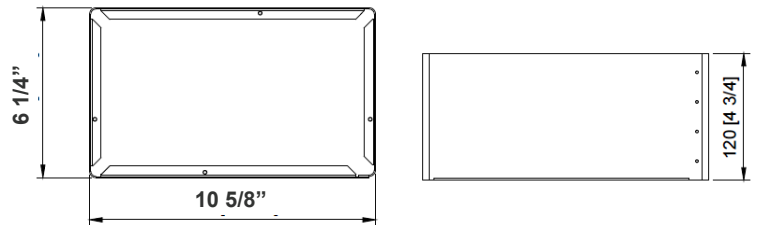

LFX-WG-A
 Wire Guard

