



KT-WPLED35PS-S3-8CSB-VDIM

ADJUSTABLE WALL PACK

DESCRIPTION

0° - 90° Adjustable LED Wall Pack | Power Select | Color Select | 120-277V | Bronze Housing

APPLICATION

Commercial wall mount applications for outdoor illumination (alleys, pathways, landscape lighting)



PRODUCT FEATURES

- Keystone Power Select technology (35/25/15W)
- Keystone Color Select technology (3000/4000/5000K)
- 0° - 90° field adjustable light positioning to illuminate areas missed by traditional forward throw wall packs
- Heavy duty, die cast aluminum housing with enhanced performance and reliability
- Built in dusk to dawn photocell behind translucent 3/4" threaded plug with antiyellowing agent
- Keystone 0-10V dimming driver
- Ambient operating temperature: -40°C/-40°F - 50°C/122°F
- UL certified, DLC listed, IP65 rated
- THD: < 20%
- LED chip lifetime: L70 > 100,000 hrs @ 25°C/77°F ambient fixture temperature
- Meets FCC Part 15, Part B, Class A standards for conducted and radiated emissions

PRODUCT SPECIFICATIONS

Catalog Number	Wattage	CCT	Lumens	Efficacy	Dimming	CRI	Input Voltage	Mounting	Photocell	Housing Color	Rated Life	Legacy Equivalent
KT-WPLED35PS-S3-8CSB-VDIM	35W	3000K	4375	125 lm/W	0-10V	>80	120-277V	Wall Mount	Included	Bronze	50,000 hrs	150W MH
		4000K	5075	145 lm/W								
		5000K	4725	135 lm/W								
	25W	3000K	3375	135 lm/W								
		4000K	3750	150 lm/W								
		5000K	3625	145 lm/W								
	15W	3000K	2178	145 lm/W								
		4000K	2325	155 lm/W								
		5000K	2250	150 lm/W								

PHYSICAL SPECIFICATIONS

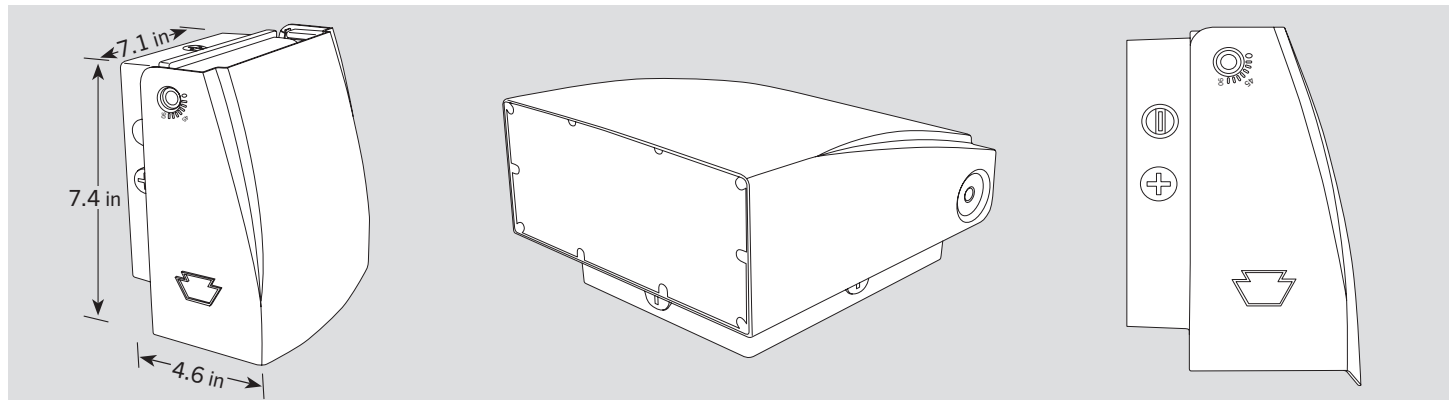

KT-WPLED35PS-S3-8CSB-VDIM

ADJUSTABLE WALL PACK

PHOTOMETRICS

Full cutoff wall pack
35W 5000K
Building mounted 15'

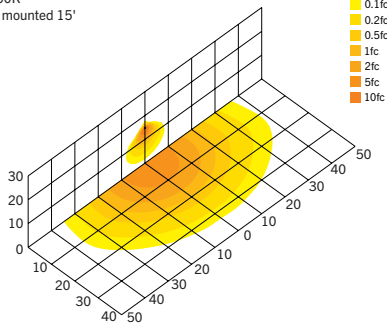

Full cutoff wall pack
25W 5000K
Building mounted 15'

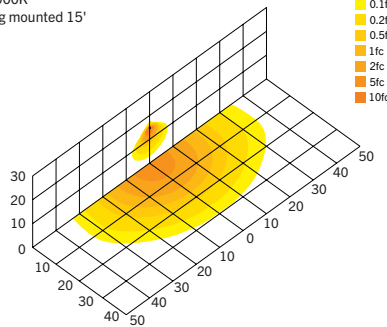

Full cutoff wall pack
15W 5000K
Building mounted 15'

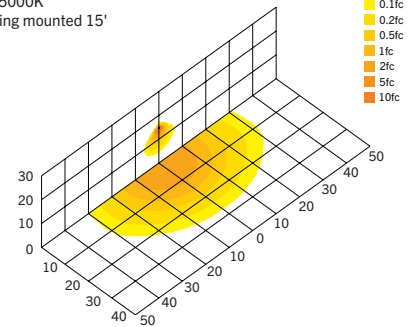

Luminous Intensity Distribution Curve

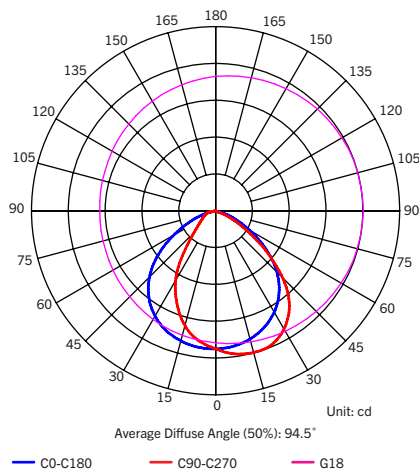

Isocandela (Rectangle)

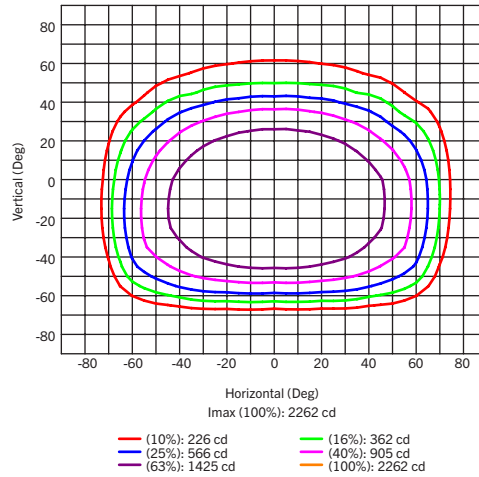

ZONE	LUMENS	% LAMP LUMENS
FORWARD LIGHT	2938	60.3
FL (0° - 30°)	904	18.6
FM (30° - 60°)	1674	34.4
FH (60° - 80°)	352	7.2
FVH (80° - 90°)	9	0.2

BACK LIGHT	1886	38.7
BL (0° - 30°)	768	15.8
BM (30° - 60°)	917	18.8
BH (60° - 80°)	175	3.6
BVH (80° - 90°)	23	0.5

UP LIGHT	49	1.0
UL (90° - 100°)	5	0.1
UH (100° - 180°)	44	0.9

TRAPPED LIGHT	NA	NA
----------------------	-----------	-----------

BUG (Backlight, Uplight, Glare) Rating Base On TM-15-07	
Asymmetrical Luminaire Types (Type I, II, III, IV)	B2 U2 G1
Quadrilateral Symmetrical Luminaire Types (Type V, Area Light)	B2 U2 G1



KT-WPLED35PS-S3-8CSB-VDIM

ADJUSTABLE WALL PACK

GENERAL SETUP INSTRUCTIONS

GENERAL WIRING DIAGRAM

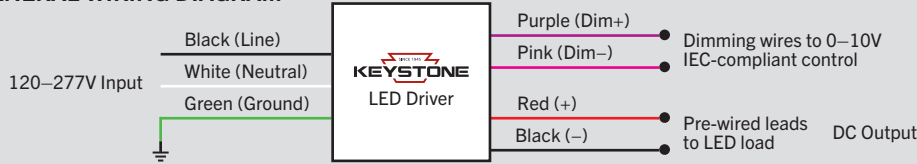

Caution: Before installing, make certain that AC power to the fixture is off.

Caution: The electrical rating of this product is 120–277V. Installer must confirm that there is 120–277V at the fixture before installation.

Note: *In accordance with NEC-20 410.69 2022, all 0-10V negative wires have been updated from gray to pink. Please contact Keystone for details

ANGLE ADJUSTMENT INSTRUCTIONS

1. Loosen the screw on the side of the housing using an Allen wrench.
2. Adjust housing to desired setting, 0° - 90° in 15° intervals.
3. Tighten the screw on the side of the housing using the Allen wrench in Step 1.

PHOTOCELL AND CCT ADJUSTMENT

This fixture is equipped with a dusk to dawn photocell behind the translucent knockout (KO). Enable or disable the photocell by removing the cap and adjusting the dip switch to your desired setting. Fixture comes preset with photocell enabled. This fixture is also equipped with Keystone Color Select technology. The CCT dip switch is located in the same KO as the photocell. Remove the cap and adjust to your desired setting. This fixture comes preset to 5000K.

WATTAGE ADJUSTMENT

This fixture is equipped with Keystone Power Select technology. The adjustable knob is located in the driver compartment. See instructions below on how to access. Fixture comes preset to either 75W or 35W, depending on model ordered.

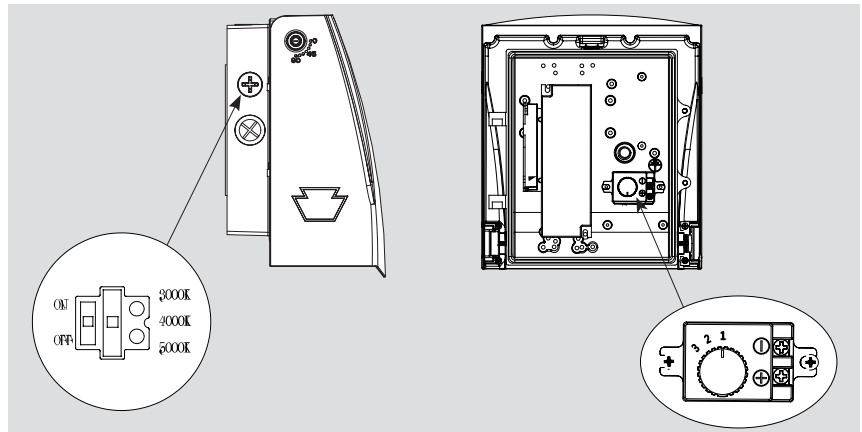

Photocell and CCT Adjustment

Wattage Adjustment

Note: Settings in drawing used for reference. Different models will show different settings.

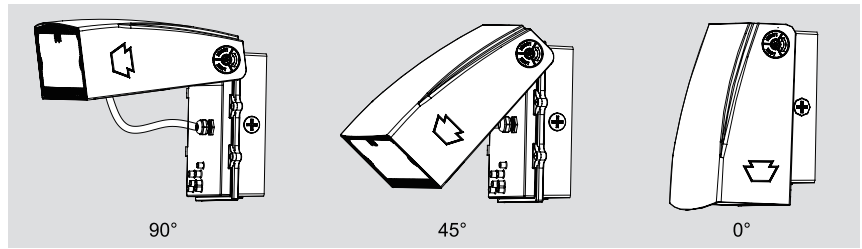

ORDERING INFORMATION

Catalog Number	Easy Code	UPC
KT-WPLED35PS-S3-8CSB-VDIM	ZRH-81	843654141848

CATALOG NUMBER BREAKDOWN

KT-WPLED35PS-S3-8CSB-VDIM

1	2	3	4	5	6	7	8	9	10	11
1 Keystone Technologies	2 Wall Pack	3 LED	4 Max Wattage	5 Power Select	6 Size	7 Style	8 CRI	9 Color Select	10 Color Select Designation	11 0-10V Dimming
					S Small	3 Adjustable Full Cutoff	8 >80		B 3000/4000/5000K	