

KT-WDLED14PS-6B-9CSF-VDIM

6" LED RECESSED WAFER DOWNLIGHT

DESCRIPTION

6" LED Recessed Wafer Downlight | Power Select Technology | Color Select Technology | Remote Driver with Built-in Junction Box

APPLICATION

Ideal for residential, hospitality, retail, office, and other retrofit and new construction applications



PRODUCT FEATURES

- Keystone Power Select and Color Select technologies offer SKU reduction and allow for easy, on-the-job adjustments
- Utilizes a remote driver with built-in junction box and quick disconnect; Eliminates the need for a traditional, multi-piece fixture setup
- CEC Compliant Flicker Rate (CEC JA10 std.)
- Ideal for new construction, remodel, and retrofit applications
- Flat body allows fit for shallow ceilings
- Edge-lit LED technology provides even illumination
- Interchangeable trims available in matte black, brushed nickel, and bronze
- Powered by Keystone 0–10V dimming LED driver; 10–100% dimming
- Ambient operating temperature: –30°C/–22°F to 40°C/104°F
- Suitable for use in wet locations
- Airtight and Type IC-rated
- Power factor: >0.90
- THD: <20%
- LED chip lifetime: L70 >80,000 hrs @ 25°C/77°F ambient fixture temp
- FCC Part 15, Subpart B, Class A

PERFORMANCE SPECIFICATIONS

Catalog Number	Input Voltage	Wattage (Selectable)	CCT (Selectable)*	Lumen Output	Efficacy	CRI	Power Factor	Beam Angle	Lifetime
KT-WDLED14PS-6B-9CSF-VDIM	120–277V	14W	2700K	1,150	82 lm/W	>90	>0.9	110°	50,000 hrs
			3000K	1,175	84 lm/W				
			3500K	1,200	86 lm/W				
			4000K	1,220	87 lm/W				
			5000K	1,205	86 lm/W				
		12W	2700K	980	82 lm/W				
			3000K	1,010	84 lm/W				
			3500K	1,040	87 lm/W				
			4000K	1,070	89 lm/W				
			5000K	1,045	87 lm/W				
		10W	2700K	820	82 lm/W				
			3000K	840	84 lm/W				
			3500K	865	87 lm/W				
			4000K	885	89 lm/W				
			5000K	870	87 lm/W				

*Preset to highest CCT: 5000K
 Color Uniformity: CCT (Correlated Color Temperature) range as per guidelines outlined in ANSI C78.377-2017

KT-WDLED14PS-6B-9CSF-VDIM

6" LED RECESSED WAFER DOWNLIGHT

PHOTOMETRIC SPECIFICATIONS

POLAR CANDELA DISTRIBUTION

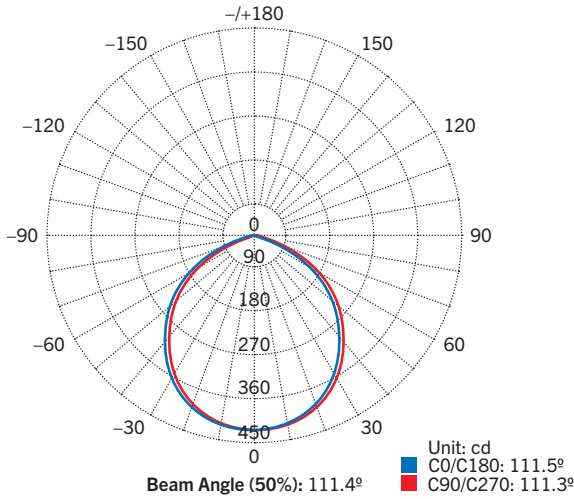

LUX DISTANCE CURVE

Flux Out: 868.7 lm

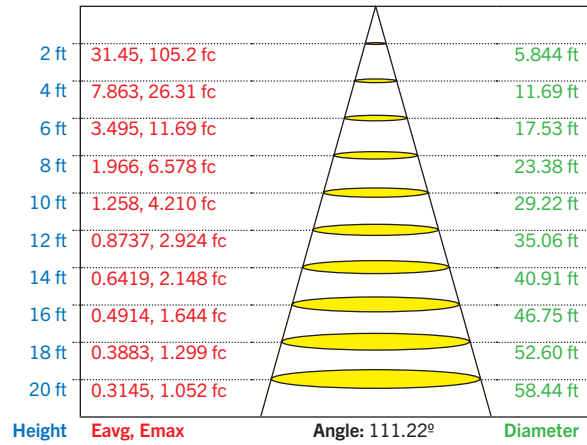

Curves show illuminated area and average illumination when lamp is at various distances.

PHYSICAL SPECIFICATIONS

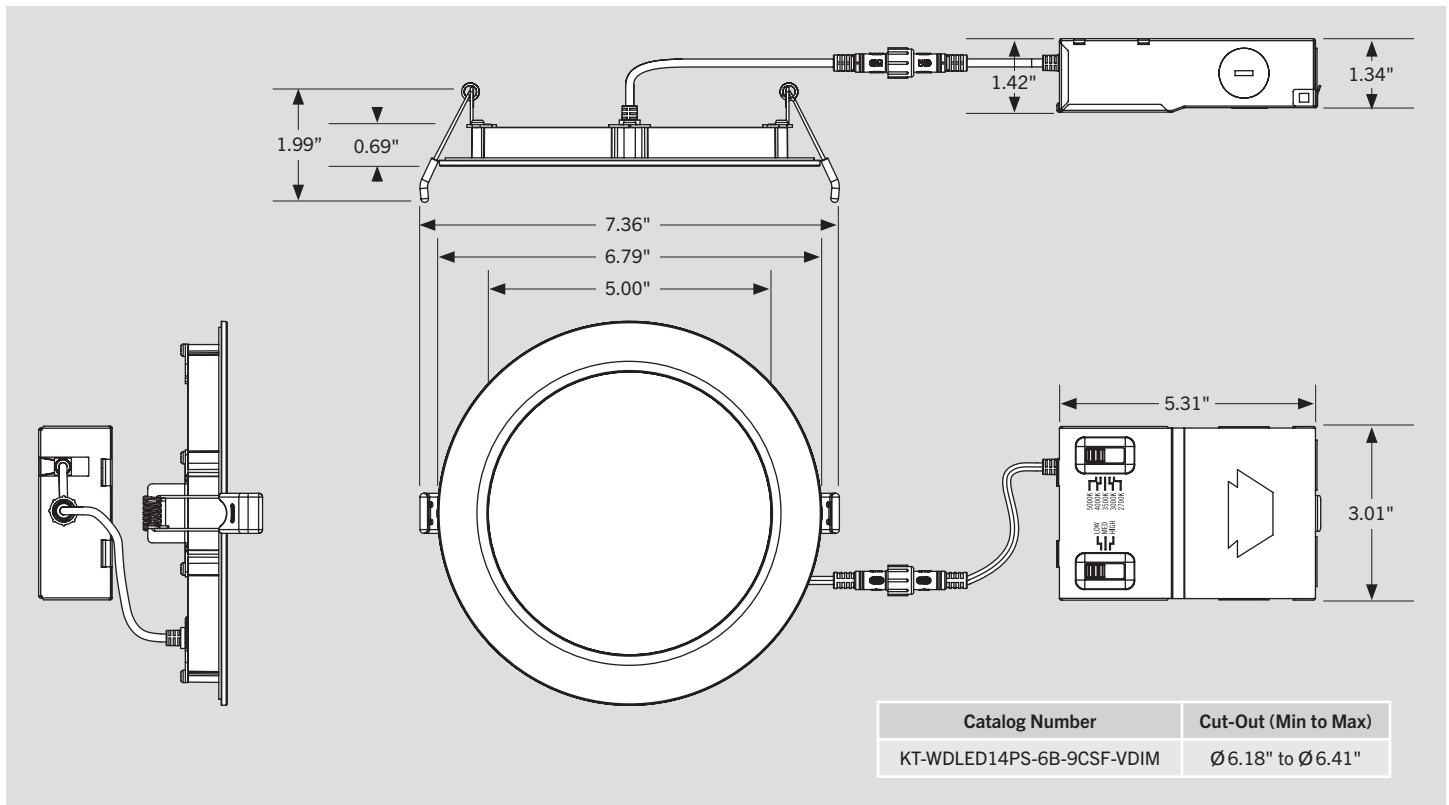

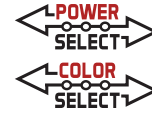

KT-WDLED14PS-6B-9CSF-VDIM

6" LED RECESSED WAFER DOWNLIGHT

POWER SELECT (WATTAGE) AND COLOR SELECT (CCT) ADJUSTMENT

This fixture is equipped with field-adjustable Keystone Power Select and Color Select technology.

1. Ensure power is off to the fixture.
2. Adjust dip switches to desired settings.

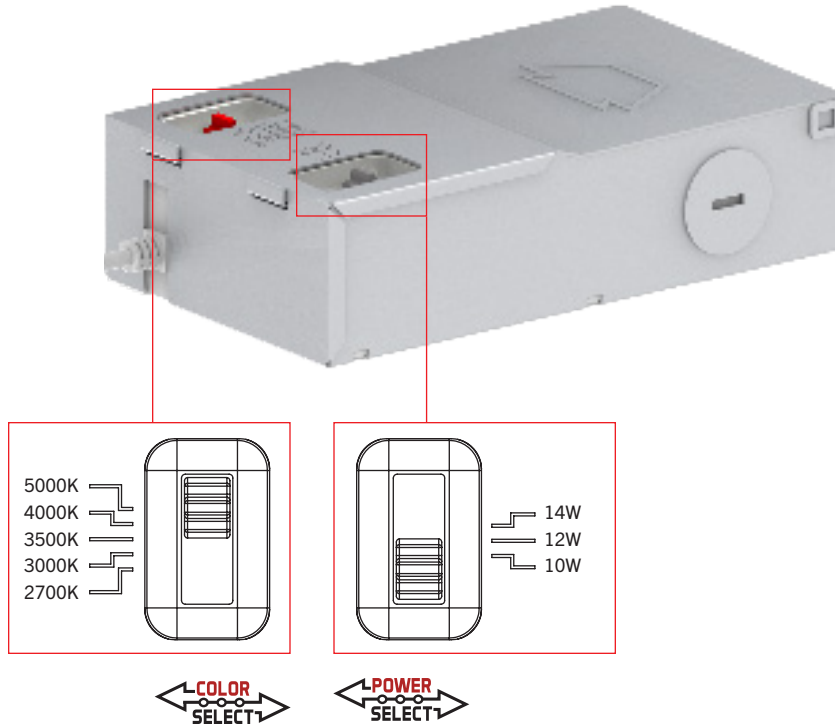

COLOR SELECT ADJUSTMENT SWITCH
 Set dip switch to adjust CCT between 2700K, 3000K, 3500K, 4000K, and 5000K. Fixture comes preset at 5000K.

POWER SELECT ADJUSTMENT SWITCH
 Set dip switch to adjust wattage between 10W, 12W, and 14W. Fixture comes preset at 14W.

WIRING DIAGRAM

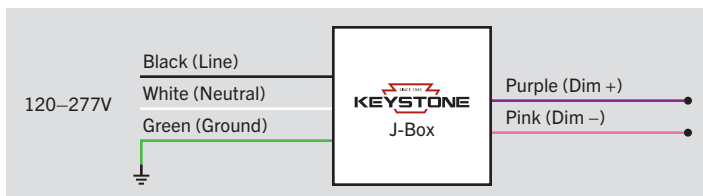

KT-WDLED14PS-6B-9CSF-VDIM

6" LED RECESSED WAFER DOWNLIGHT

INSTALLATION INSTRUCTIONS

RETROFIT INSTALLATION

- 1. Shut off power at the source of the fixture housing into which you are installing fixture.**

Remove existing trim, CFL or incandescent bulb.

Note: Follow all federal and local regulations when disposing of lamps and removed components.

- 2. Measure ceiling opening to ensure that the edge of the luminaire will cover the entire opening and still sit firmly in the ceiling (see *Dimensions* on page 2).**

- 3. Select desired Wattage and CCT using adjustment switches on fixture (see *Power Select (Wattage) and Color Select (CCT) Adjustment* on page 3).**

- 4. Open the driver box and remove the knockout(s) (KO).**

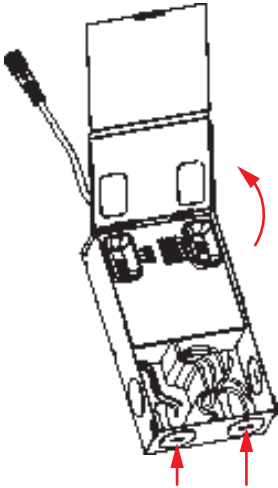

- 5. Insert the electrical supply cable through the KO; use appropriate bushing to prevent wire abrasion. Wire driver box (see *Wiring Diagram* on page 3 and illustration below).***

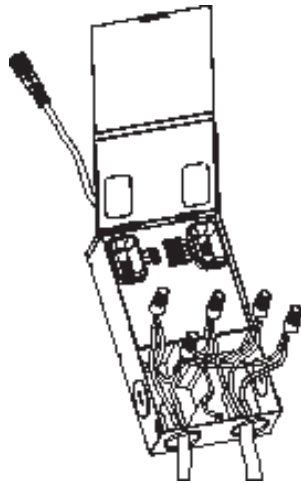

- 6. Place all wiring and connections back into the box and close the cover.**

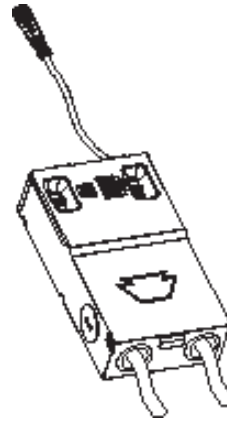

- 7. Insert driver box into ceiling in accordance with local/national codes and connect the male and female connectors. Screw threaded nut over connectors to secure.**

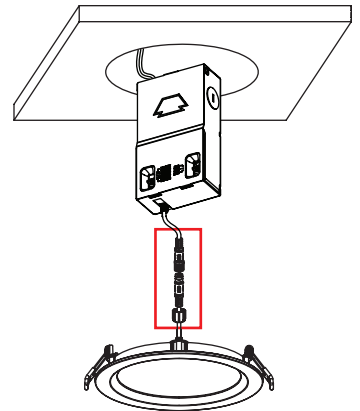

- 8. Lifting both retention tabs upward, push the fixture into the hole until trim sits flush with ceiling.**

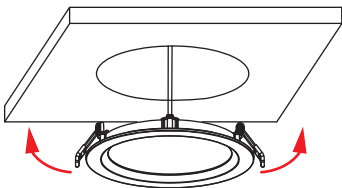

- 9. Restore power when ready.**

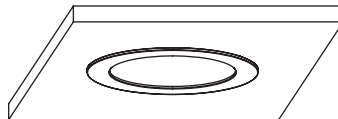

* Keystone offers an optional cable accessory to assist with wiring to existing fixture J-box. See KT-MC-NP-1-18/3, Optional Accessories (sold separately) on page 6.

(Installation Instructions continued on next page)

KT-WDLED14PS-6B-9CSF-VDIM

6" LED RECESSED WAFER DOWNLIGHT

INSTALLATION INSTRUCTIONS (continued)

NEW-CONSTRUCTION INSTALLATION*

- 1. Shut off power at the source of the fixture housing into which you are installing fixture.**
- 2. Using installation hole template, create ceiling opening to ensure that the edge of the luminaire will cover the entire opening and still sit firmly in the ceiling (see *Dimensions* on page 2).**
- 3. Select desired Wattage and CCT using adjustment switches on fixture (see *Power Select (Wattage) and Color Select (CCT) Adjustment* on page 3).**

- 4. Open the driver box and remove the knockout(s) (KO).**

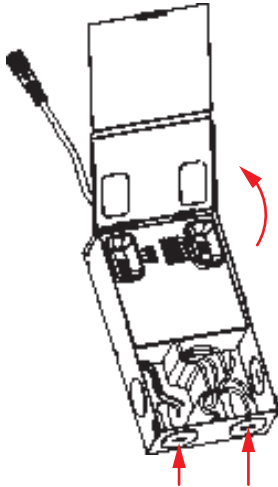

- 5. Insert the electrical supply cable through the KO; use appropriate bushing to prevent wire abrasion. Wire driver box (see *Wiring Diagram* on page 3 and illustration below).***

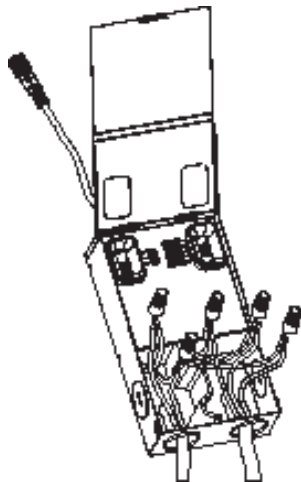

- 6. Place all wiring and connections back into the box and close the cover.**

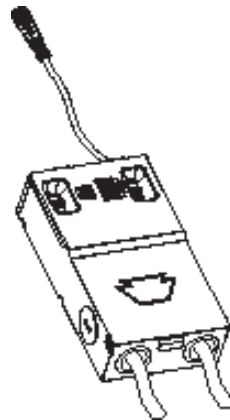

- 7. Insert driver box into ceiling in accordance with local/national codes and connect the male and female connectors. Screw threaded nut over connectors to secure.**

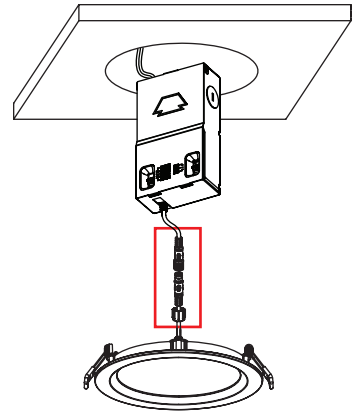

- 8. Lifting both retention tabs upward, push the fixture into the hole until trim sits flush with ceiling.**

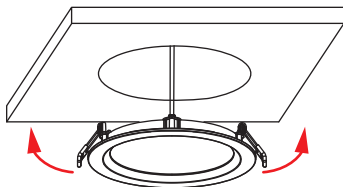

- 9. Restore power when ready.**

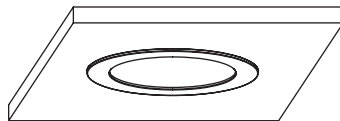

* Keystone offers an optional cable accessory to assist with wiring to existing fixture J-box. See KT-MC-NP-1-18/3, Optional Accessories (sold separately) on page 6.

KT-WDLED14PS-6B-9CSF-VDIM

6" LED RECESSED WAFER DOWNLIGHT

OPTIONAL ACCESSORIES (sold separately)

INTERCHANGEABLE TRIM

Catalog Number	Description	UPC	Easy Code
KT-WDLED-6B-MB-TRIM	6" Interchangeable Trim for 6B LED Recessed Wafer Downlight; Matte Black	843654139425	WDA-66
KT-WDLED-6B-BN-TRIM	6" Interchangeable Trim for 6B LED Recessed Wafer Downlight; Brushed Nickel	843654139456	SDC-23
KT-WDLED-6B-BR-TRIM	6" Interchangeable Trim for 6B LED Recessed Wafer Downlight; Bronze	843654139487	HEB-17

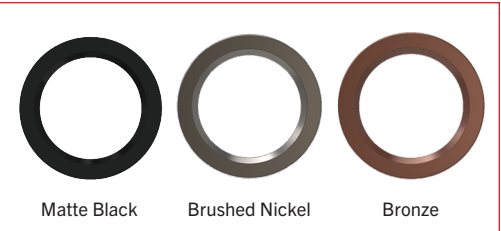

GOOF RING

Catalog Number	Description	UPC	Easy Code
KT-WDLED-6AB-GOOF	Goof Ring for 6A/6B LED Wafer Downlights; 8" outer diameter	843654139654	MKE-35

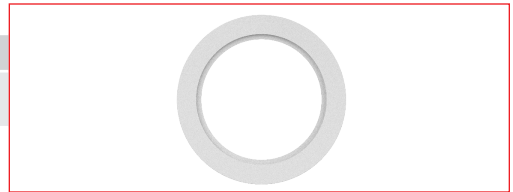

NEW-CONSTRUCTION PLATE

Catalog Number	Description	UPC	Easy Code
KT-WDLED-PLATE-2	New Construction Mounting Plate for all A and B LED Wafer Downlights for joist and T-grid installations	843654139791	FZT-71

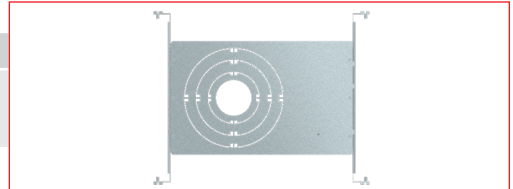

EXTENSION CABLES

Catalog Number	Description	UPC	Easy Code
KT-WDLED-EC-6	6' Extension Cord for LED Wafer Downlights	843654139739	GOK-14
KT-WDLED-EC-12	12' Extension Cord for LED Wafer Downlights	843654139746	ECE-88
KT-WDLED-EC-20	20' Extension Cord for LED Wafer Downlights	843654139753	JLM-06

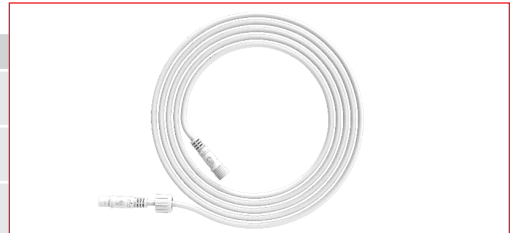

METAL-CLAD CABLE

Catalog Number	Description	UPC	Easy Code
KT-MC-NP-1-18/3	Metal-Clad Cable for LED Recessed Downlights; No plug; UL 16AWG 18/3 wire (live, neutral, ground)	843654139777	AYT-71

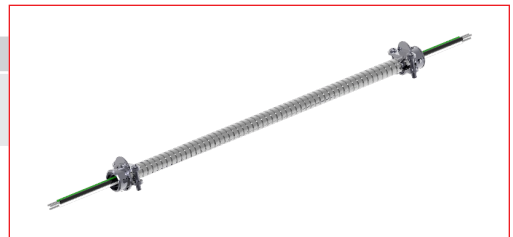

EMERGENCY PACK

Catalog Number	Description	UPC	Easy Code
KT-EMRG-LED-12-1200-AC/DF	LED Emergency Backup, 12W - 1200 Lumen Constant Power Design. 120-277V Input. Dual Flex Cable Design. Installs on Primary Side of AC Powered LED load.	843654139890	MPM-43



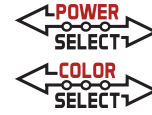

KT-WDLED14PS-6B-9CSF-VDIM

6" LED RECESSED WAFER DOWNLIGHT

ORDERING INFORMATION

Catalog Number	Pack Qty.	UPC	Easy Code
KT-WDLED14PS-6B-9CSF-VDIM	1	843654139234	EQA-80

CATALOG NUMBER BREAKDOWN

KT-WDLED14PS-6B-9CSF-VDIM

1 2 3 4 5 6 7 8 9 10 11

- 1 Keystone Technologies
- 2 Fixture Type

WD	Wafer Downlight
----	-----------------
- 3 LED Technology
- 4 Maximum Wattage
- 5 Power Select Technology
- 6 Size

6	6" Nominal
---	------------
- 7 Style/Design Designation

B	Series B
---	----------
- 8 CRI

9	90
---	----
- 9 Color Select Technology
- 10 Color Select Designation

F	2700K, 3000K, 3500K, 4000K, 5000K
---	-----------------------------------
- 11 Dimming

VDIM	0-10V Dimming
------	---------------