

# KT-RKIT45PS-24DB-8CSA-VDIM

## DOORFRAME RETROFIT KIT

**DESCRIPTION**

2x4' LED DoorFrame Retrofit Kit | 120-277V | 0-10V Dimming



**PRODUCT FEATURES**

- Features Keystone Color Select technology. Adjust CCT between 3500K, 4000K, or 5000K
- Features Keystone Power Select technology. Adjust power between 45W, 38W, and 30W
- Used to Upgrade existing 2x4 fluorescent recessed troffer, without modifying existing fixture mounting.
- Powered by Keystone 0 –10V dimming LED drivers with 12V Aux
- Ambient operating temperature: -20°C/-4°F to 50°C/122°F
- Compatible with Keystone SmartSafe emergency backups
- Available with optional integral occupancy sensor accessory, KTSL-FC2-12V-SM-PIR
- Low optical flicker
- THD: < 20%
- Power factor > 0.95

**POWER AND COLOR TEMPERATURE SELECTABILITY**

- Keystone Color Select Technology: Adjustable CCT (3500K/4000K/5000K)
- Keystone Power Select Technology: Adjustable Wattage (45W/38W/30W)

**PRODUCT SPECIFICATIONS**

Catalog Number	Input Voltage	Wattage	CCT	Lumen Output	Efficacy	CRI	Power Factor	Lifetime
KT-RKIT45PS-24DB-8CSA-VDIM	120–277V	45W	3500K	5,760	128 lm/W	> 80	> 0.90	50,000 hrs
			4000K	5,805	129 lm/W			
			5000K	5,850	130 lm/W			
		38W	3500K	4,978	131 lm/W			
			4000K	5,016	132 lm/W			
			5000K	5,054	133 lm/W			
		30W	3500K	4,110	137 lm/W			
			4000K	4,140	138 lm/W			
			5000K	4,170	139 lm/W			

**ONE CATALOG NUMBER WITH 9 DIFFERENT OPTIONS**

\* Preset to highest lumen output (45W / 5000K)  
 \* Color Uniformity: CCT (Correlated Color Temperature) range as per guidelines outlined in ANSI C78.377-2017.

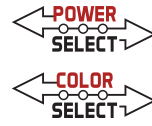

# KT-RKIT45PS-24DB-8CSA-VDIM

## LED CENTER BASKET FIXTURE

### PHOTOMETRIC SPECIFICATIONS

#### ISOCANDELA PLOT

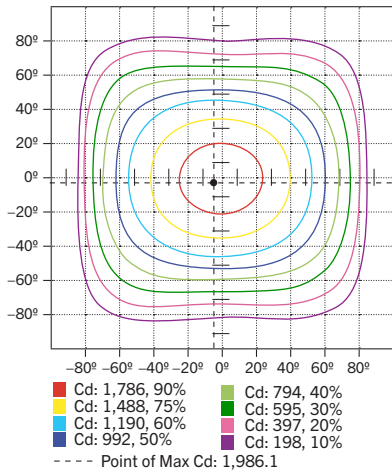

#### POLAR CANDELA DISTRIBUTION

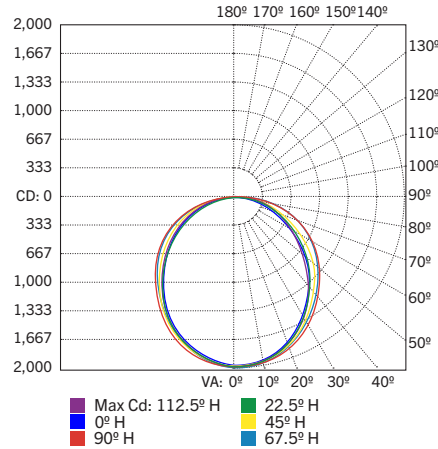

#### ZONAL LUMEN SUMMARY

Zone	Lumens	% Luminaire
0-60	4,408.2	75.50%
60-90	1,415.4	24.20%
0-90	5,823.5	99.70%
90-180	15.9	0.30%
0-180	5,839.5	100%

### PHYSICAL SPECIFICATIONS

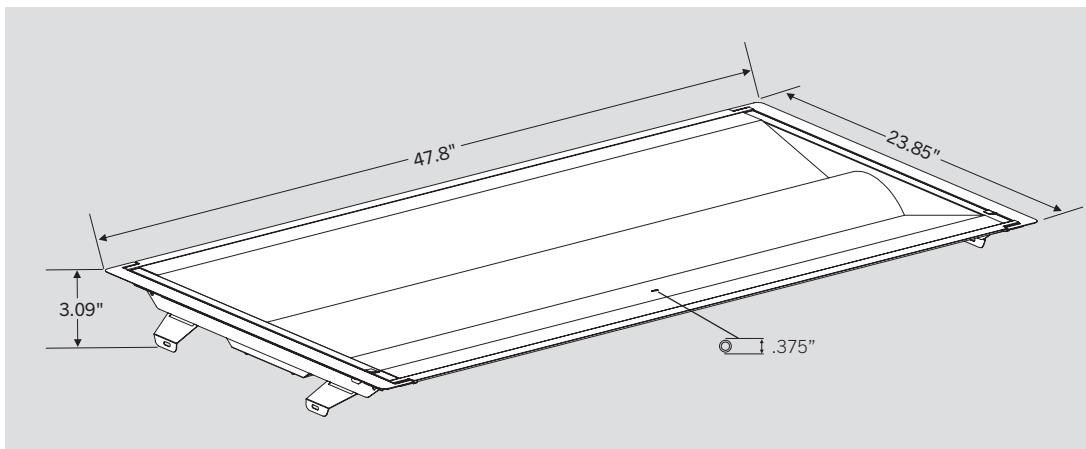

### WIRING DIAGRAMS

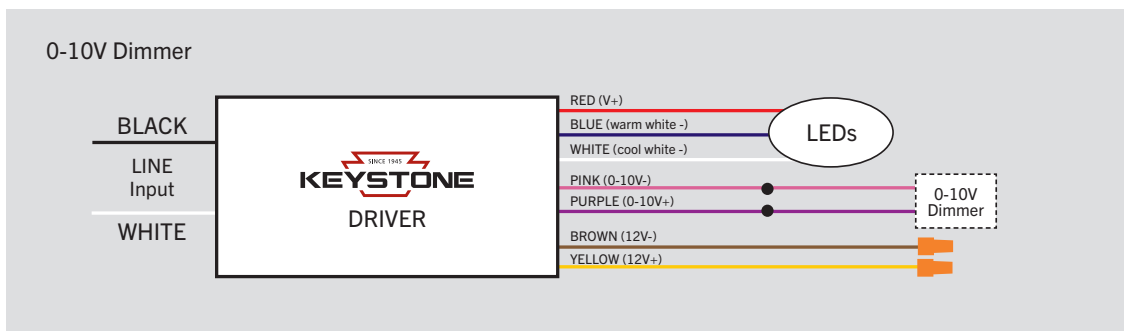

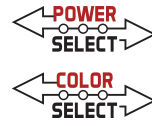

# KT-RKIT45PS-24DB-8CSA-VDIM

## LED CENTER BASKET FIXTURE

**WIRING DIAGRAMS** (continued)

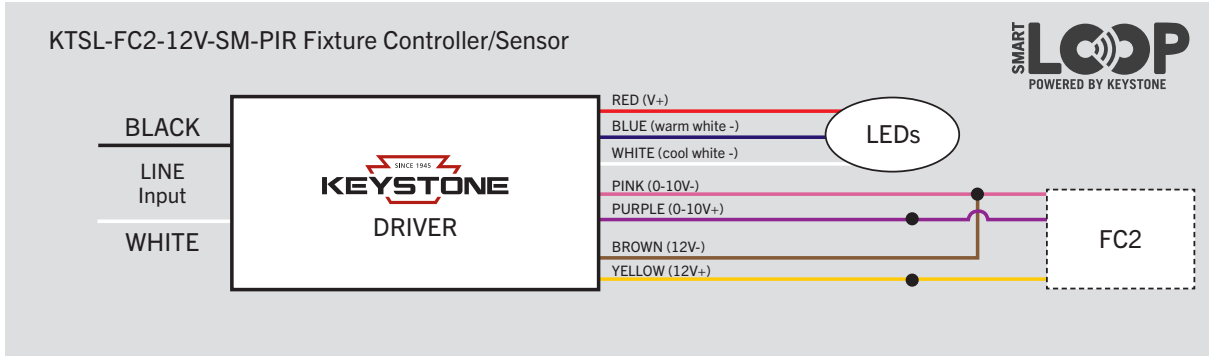

**ADDITIONAL ACCESSORIES (SOLD SEPARATELY)**

Catalog Number	Description
KT-EMRG-LED-5C-500	LED Emergency Back-Up, 5W Constant Wattage Design, Approx 500 lumens
KT-EMRG-LED-12C-1200	LED Emergency Back-Up, 12W Constant Wattage Design, Approx 1200 lumens.
KTSL-FC2-12V-SM-PIR	Bluetooth mesh wireless low voltage fixture controller for SmartLoop system with integrated daylight and PIR motion sensors

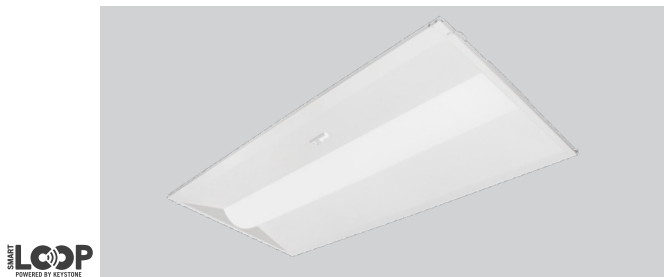

Fixture installed with KTSL-FC2-12V-SM-PIR

**ORDERING INFORMATION**

Catalog Number	Pack Quantity	Easy Code	UPC
KT-RKIT45PS-24DB-8CSA-VDIM	TBD	ONZ-96	843654134840

**CATALOG NUMBER BREAKDOWN**

# KT-RKIT45PS-24DB-8CSA-VDIM

- 1
- 2
- 3
- 4
- 5
- 6
- 7
- 8
- 9
- 10
- 11

- 1 Keystone Technologies
- 2 Retrofit Kit
- 3 Wattage
- 4 Power Select
- 5 2X4' Nominal Length
- 6 Lamp Type
- 7 80 CRI
- 8 Color Select
- 9 Color Select Designation
- 10 0–10V Dimming
- 11 Sensor Options

**9 Color Select Designation**

A	3500K, 4000K, 5000K
---	---------------------

**11 Sensor Options**

	No option
/FC2-PIR	SmartLoop PIR sensor included