

KT-RKIT35PS-14DB-8CSA-VDIM

DOORFRAME RETROFIT KIT

DESCRIPTION

1x4 LED DoorFrame Retrofit Kit | 120-277V | Frosted Lens | 0-10V Dimming



5 YEAR
WARRANTY

PRODUCT FEATURES

- Features Keystone Color Select technology. Adjust CCT between 3500K, 4000K, or 5000K
- Features Keystone Power Select technology. Adjust power between 35W, 30W, and 24W
- Used to Upgrade existing 1X4 fluorescent recessed troffer, without modifying existing fixture mounting.
- Powered by Keystone 0 –10V dimming LED drivers with 12V Aux
- Ambient operating temperature: -20°C/-4°F to 50°C/122°F
- Compatible with Keystone SmartSafe emergency backups
- Available with optional integral occupancy sensor accessory, KTSL-FC2-12V-SM-PIR
- Low optical flicker
- THD: < 20%
- Power factor > 0.95

POWER AND COLOR TEMPERATURE SELECTABILITY

- Keystone Color Select Technology: Adjustable CCT (3500K/4000K/5000K)
- Keystone Power Select Technology: Adjustable Wattage (35W/30W/24W)

PRODUCT SPECIFICATIONS

Catalog Number	Input Voltage	Wattage	CCT	Lumen Output	Efficacy	CRI	Power Factor	Lifetime
KT-RKIT35PS-14DB-8CSA-VDIM	120–277V	35W	3500K	4,375	125 lm/W	> 80	> 0.90	50,000 hrs
			4000K	4,410	126 lm/W			
			5000K	4,445	127 lm/W			
		30W	3500K	3,840	128 lm/W			
			4000K	3,870	129 lm/W			
			5000K	3,900	130 lm/W			
		24W	3500K	3,144	131 lm/W			
			4000K	3,168	132 lm/W			
			5000K	3,192	133 lm/W			

ONE CATALOG NUMBER WITH 9 DIFFERENT OPTIONS

* Preset to highest lumen output (35W / 5000K)

* Color Uniformity: CCT (Correlated Color Temperature) range as per guidelines outlined in ANSI C78.377-2017

KT-RKIT35PS-14DB-8CSA-VDIM

DOORFRAME RETROFIT KIT

PHOTOMETRIC SPECIFICATIONS

POLAR CANDELA DISTRIBUTION

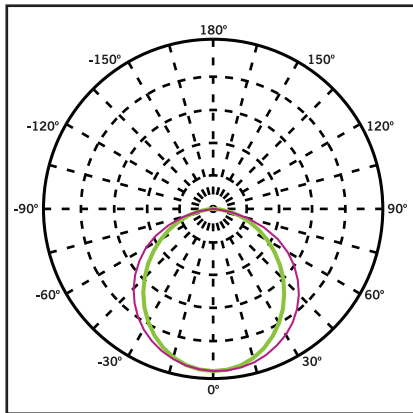

Maximum Candela = 1525.2
Located at Horizontal Angle = 0,
Vertical Angle 0

1. Violet Vertical Plane through Horizontal Angles (90-270)
2. Green Vertical Plane through Horizontal Angles (0-180)

Beam Angle: 220°

Visible Light Area: 325°

RELATIVE SPECTRAL POWER DISTRIBUTION

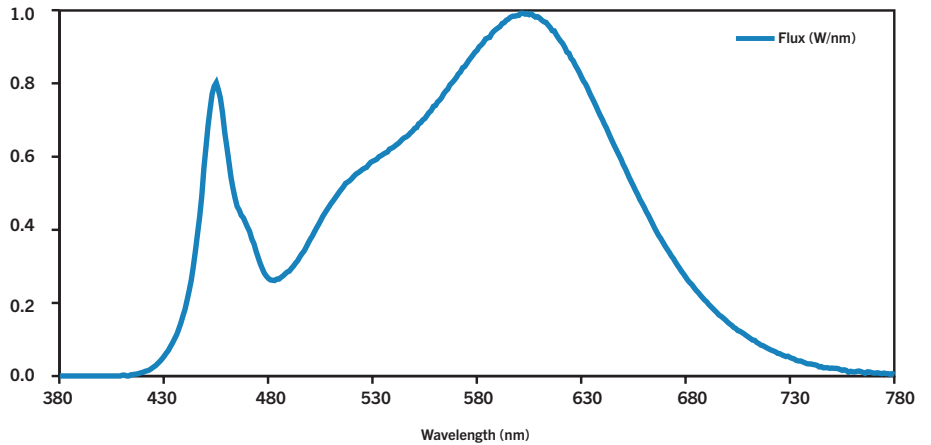

PHYSICAL SPECIFICATIONS

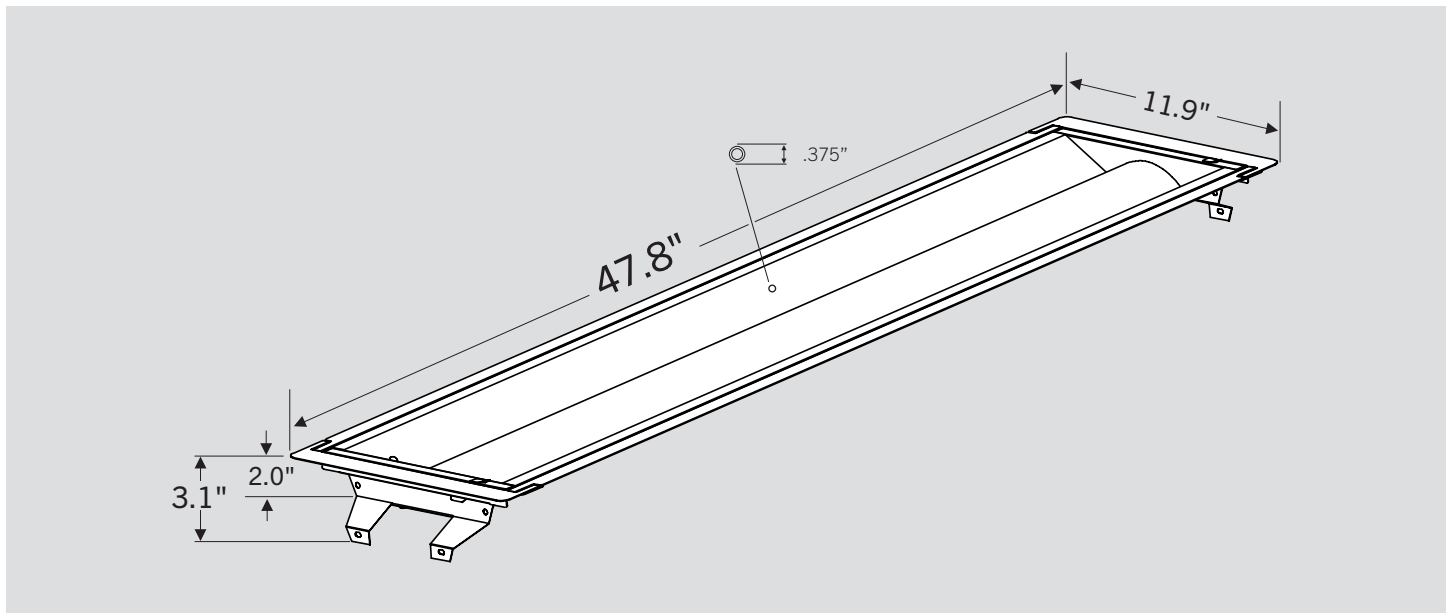

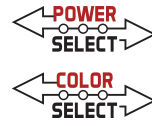

KT-RKIT35PS-14DB-8CSA-VDIM

DOORFRAME RETROFIT KIT

WIRING DIAGRAMS

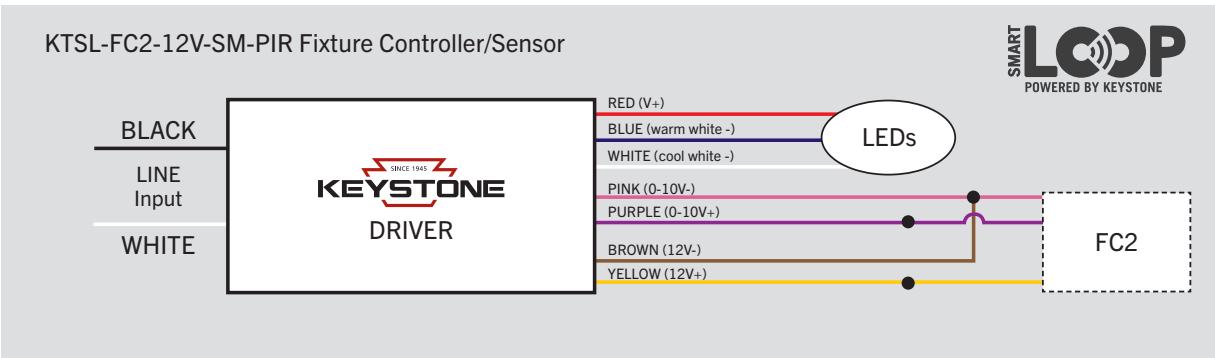
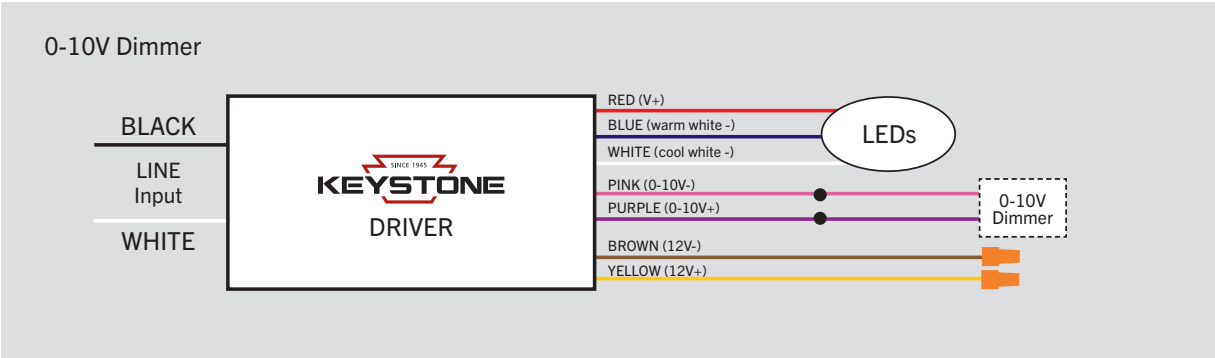

ADDITIONAL ACCESSORIES (SOLD SEPARATELY)

Catalog Number	Description
KT-EMRG-LED-5C-500	LED Emergency Back-Up, 5W Constant Wattage Design, Approx 500 lumens
KT-EMRG-LED-12C-1200	LED Emergency Back-Up, 12W Constant Wattage Design, Approx 1200 lumens.
KTSL-FC2-12V-SM-PIR	Bluetooth mesh wireless low voltage fixture controller for SmartLoop system with integrated daylight and PIR motion sensors



2x4 fixture installed with KTSL-FC2-12V-SM-PIR

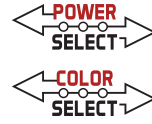

KT-RKIT35PS-14DB-8CSA-VDIM

DOORFRAME RETROFIT KIT

ORDERING INFORMATION

Catalog Number	Pack Quantity	Easy Code	UPC
KT-RKIT35PS-14DB-8CSA-VDIM	TBD	CTB-90	843654136868

CATALOG NUMBER BREAKDOWN

KT-RKIT35PS-14DB-8CSA-VDIM

1
2
3
4
5
6
7
8
9
10
11

- 1** Keystone Technologies
- 2** Retrofit Kit
- 3** Wattage
- 4** Power Select
- 5** 1X4' Nominal Length
- 6** Lamp Type
- 7** 80 CRI
- 8** Color Select
- 9** Color Select Designation
- 10** 0–10V Dimming
- 11** Sensor Options

9 Color Select Designation

A	3500K, 4000K, 5000K
---	---------------------

11 Sensor Options

	No Option
/FC2-PIR	SmartLoop PIR sensor included