

KT-RKIT30PS-24DB-8CSA-VDIM

DOORFRAME RETROFIT KIT

DESCRIPTION

2x4 LED DoorFrame Retrofit Kit | 120-277V | 0-10V Dimming



PRODUCT FEATURES

- Features Keystone Color Select technology. Adjust CCT between 3500K, 4000K, or 5000K
- Features Keystone Power Select technology. Adjust power between 30W, 25W, 20W
- Used to Upgrade existing 2x4 fluorescent recessed troffer, without modifying existing fixture mounting.
- Powered by Keystone 0 –10V dimming LED drivers with 12V Aux
- Ambient operating temperature: -20°C/-4°F to 50°C/122°F
- Compatible with Keystone SmartSafe emergency backups
- Available with optional integral occupancy sensor accessory, KTSL-FC2-12V-SM-PIR
- Low optical flicker
- THD: < 20%
- Power factor > 0.95

POWER AND COLOR TEMPERATURE SELECTABILITY

- Keystone Color Select Technology: Adjustable CCT (3500K/4000K/5000K)
- Keystone Power Select Technology: Adjustable Wattage (30W/25W/20W)

PRODUCT SPECIFICATIONS

Catalog Number	Input Voltage	Wattage	CCT	Lumen Output	Efficacy	CRI	Power Factor	Lifetime
KT-RKIT30PS-24DB-8CSA-VDIM	120–277V	30W	3500K	3,840	128 lm/W	> 80	> 0.90	50,000 hrs
			4000K	3,870	129 lm/W			
			5000K	3,900	130 lm/W			
		25W	3500K	3,350	134 lm/W			
			4000K	3,375	135 lm/W			
			5000K	3,400	136 lm/W			
		20W	3500K	2,740	137 lm/W			
			4000K	2,760	138 lm/W			
			5000K	2,780	139 lm/W			

ONE CATALOG NUMBER WITH 9 DIFFERENT OPTIONS

* Preset to highest lumen output (30W / 5000K)
 * Color Uniformity: CCT (Correlated Color Temperature) range as per guidelines outlined in ANSI C78.377-2017.

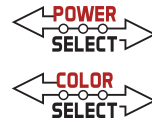

KT-RKIT30PS-24DB-8CSA-VDIM

DOORFRAME RETROFIT KIT

PHOTOMETRIC SPECIFICATIONS

ISOCANDELA PLOT

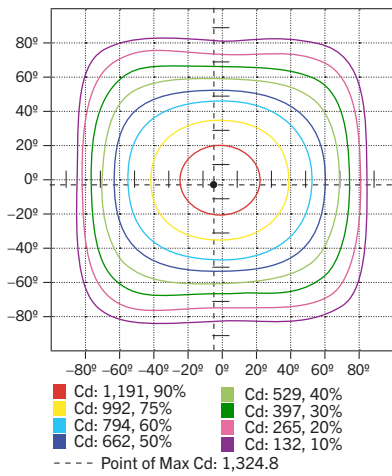

POLAR CANDELA DISTRIBUTION

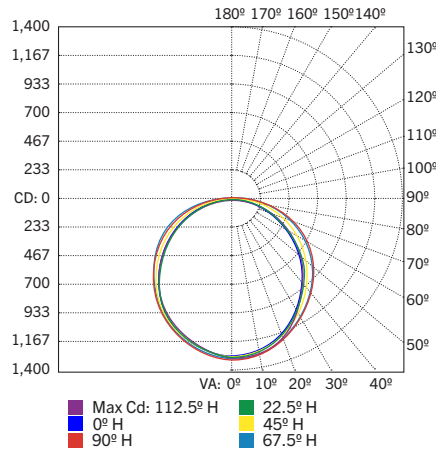

ZONAL LUMEN SUMMARY

Zone	Lumens	% Luminaire
0-60	2,940.2	75.0%
60-90	968.9	24.70%
0-90	3,909.1	99.70%
90-180	10.9	0.30%
0-180	3,920.0	100%

PHYSICAL SPECIFICATIONS

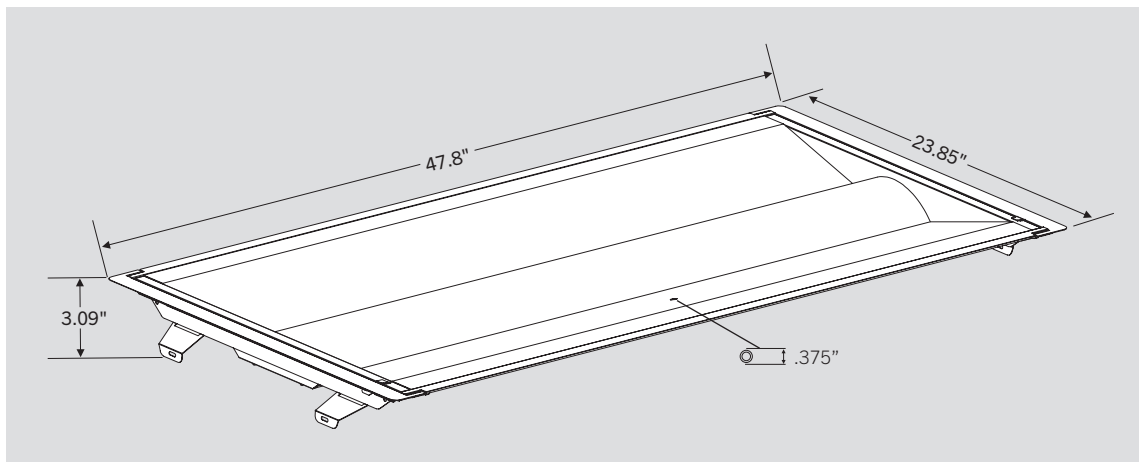

WIRING DIAGRAMS

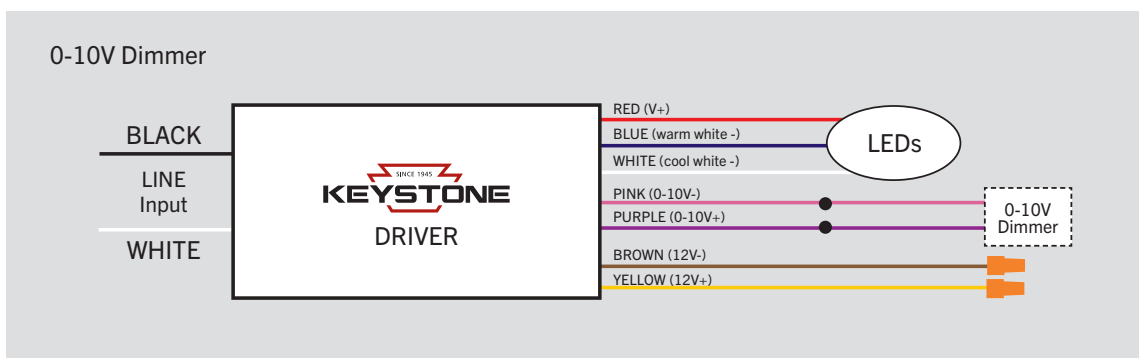

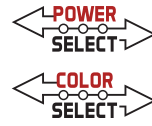

KT-RKIT30PS-24DB-8CSA-VDIM

DOORFRAME RETROFIT KIT

WIRING DIAGRAMS (CONTINUED)

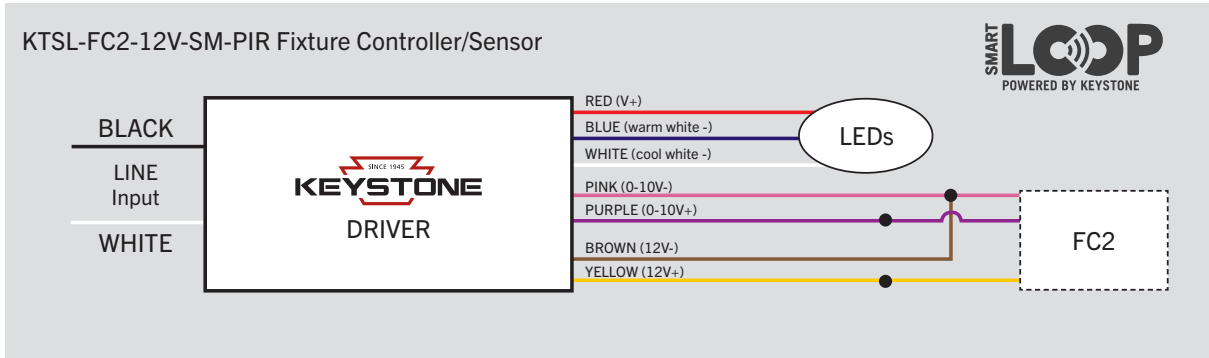

ADDITIONAL ACCESSORIES (SOLD SEPARATELY)

Catalog Number	Description
KT-EMRG-LED-5C-500	LED Emergency Back-Up, 5W Constant Wattage Design, Approx 500 lumens
KT-EMRG-LED-12C-1200	LED Emergency Back-Up, 12W Constant Wattage Design, Approx 1200 lumens.
KTSL-FC2-12V-SM-PIR	Bluetooth mesh wireless low voltage fixture controller for SmartLoop system with integrated daylight and PIR motion sensors

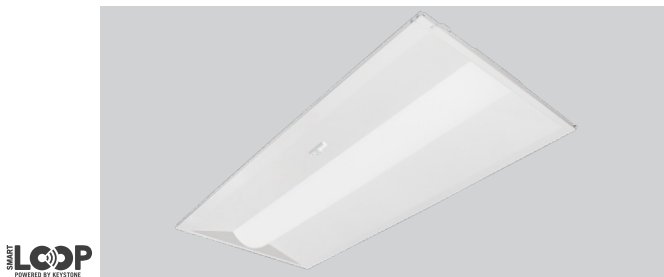

Fixture installed with KTSL-FC2-12V-SM-PIR

ORDERING INFORMATION

Catalog Number	Pack Quantity	Easy Code	UPC
KT-RKIT30PS-24DB-8CSA-VDIM	TBD	AEB-84	843654134833

CATALOG NUMBER BREAKDOWN

KT-RKIT30PS-24DB-8CSA-VDIM

1 2 3 4 5 6 7 8 9 10 11

- 1 Keystone Technologies
- 2 Retrofit Kit
- 3 Wattage
- 4 Power Select
- 5 2X4' Nominal Length
- 6 Lamp Type
- 7 80 CRI
- 8 Color Select
- 9 Color Select Designation
- 10 0–10V Dimming
- 11 Sensor Options

9 Color Select Designation

A	3500K, 4000K, 5000K
---	---------------------

11 Sensor Options

	No option
/FC2-PIR	SmartLoop PIR sensor included