

KT-RKIT24PS-22DB-8CSA-VDIM

DOORFRAME RETROFIT KIT

DESCRIPTION

2x2 LED DoorFrame Retrofit Kit | 120-277V | 0-10V Dimming



PRODUCT FEATURES

- Features Keystone Color Select technology. Adjust CCT between 3500K, 4000K, or 5000K
- Features Keystone Power Select technology. Adjust power between 24W, 18W, and 15W
- Used to Upgrade existing 2x2 fluorescent recessed troffer, without modifying existing fixture mounting.
- Powered by Keystone 0 –10V dimming LED drivers with 12V Aux
- Ambient operating temperature: -20°C/-4°F to 50°C/122°F
- Compatible with Keystone SmartSafe emergency backups
- Available with optional integral occupancy sensor accessory, KTSL-FC2-12V-SM-PIR
- Low optical flicker
- THD: < 20%
- Power factor > 0.95

POWER AND COLOR TEMPERATURE SELECTABILITY

- Keystone Color Select Technology: Adjustable CCT (3500K/4000K/5000K)
- Keystone Power Select Technology: Adjustable Wattage (24W/18W/15W)

PRODUCT SPECIFICATIONS

Catalog Number	Input Voltage	Wattage	CCT	Lumen Output	Efficacy	CRI	Power Factor	Lifetime
KT-RKIT24PS-22DB-8CSA-VDIM	120–277V	24W	3500K	3,000	125 lm/W	> 80	> 0.90	50,000 hrs
			4000K	3,024	126 lm/W			
			5000K	3,048	127 lm/W			
		18W	3500K	2,358	131 lm/W			
			4000K	2,376	132 lm/W			
			5000K	2,394	133 lm/W			
		15W	3500K	2,010	134 lm/W			
			4000K	2,025	135 lm/W			
			5000K	2,040	136 lm/W			

ONE CATALOG NUMBER WITH 9 DIFFERENT OPTIONS

* Preset to highest lumen output (24W / 5000K)
 * Color Uniformity: CCT (Correlated Color Temperature) range as per guidelines outlined in ANSI C78.377-2017

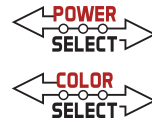

KT-RKIT24PS-22DB-8CSA-VDIM

DOORFRAME RETROFIT KIT

PHOTOMETRIC SPECIFICATIONS

ISOCANDELA PLOT

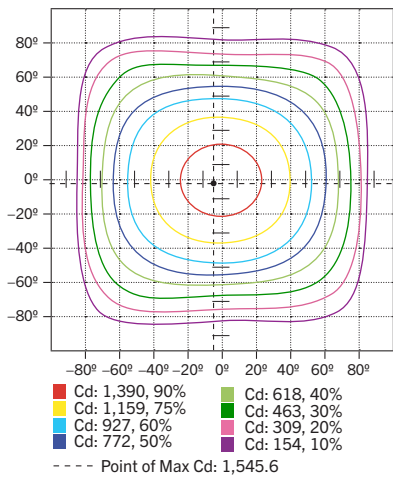

POLAR CANDELA DISTRIBUTION

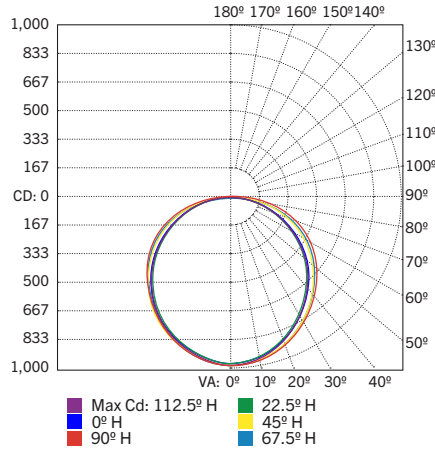

ZONAL LUMEN SUMMARY

Zone	Lumens	% Luminaire
0-60	2,249.5	74.60%
60-90	756.7	25.10%
0-90	3,006.1	99.70%
90-180	9.1	0.30%
0-180	3,015.2	100%

PHYSICAL SPECIFICATIONS

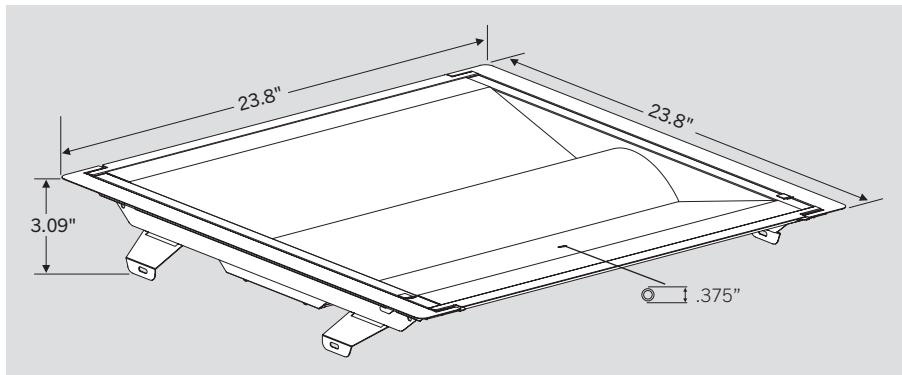

WIRING DIAGRAMS

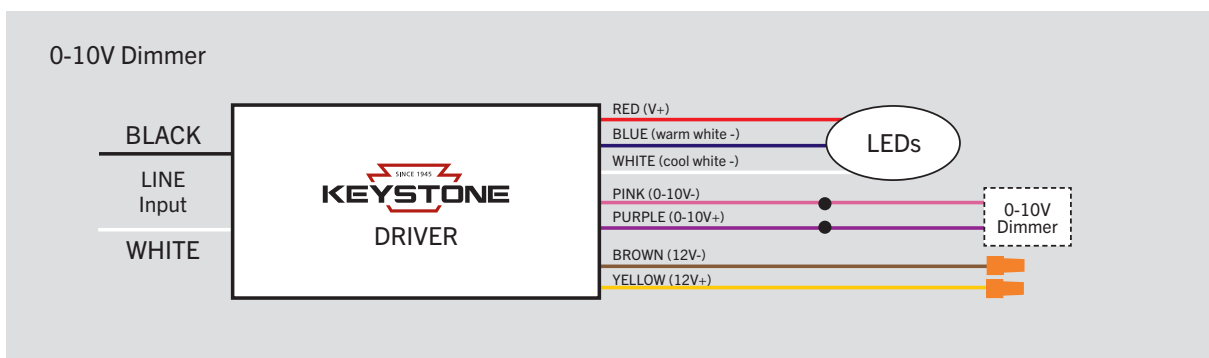

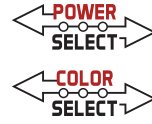

KT-RKIT24PS-22DB-8CSA-VDIM

DOORFRAME RETROFIT KIT

WIRING DIAGRAMS (CONTINUED)

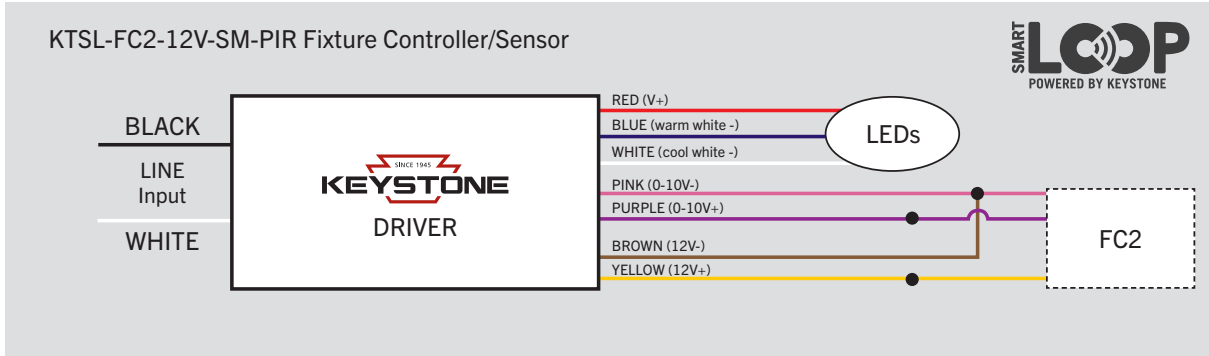

ADDITIONAL ACCESSORIES (SOLD SEPARATELY)

Catalog Number	Description
KT-EMRG-LED-5C-500	LED Emergency Back-Up, 5W Constant Wattage Design, Approx 500 lumens
KT-EMRG-LED-12C-1200	LED Emergency Back-Up, 12W Constant Wattage Design, Approx 1200 lumens.
KTSL-FC2-12V-SM-PIR	Bluetooth mesh wireless low voltage fixture controller for SmartLoop system with integrated daylight and PIR motion sensors



Fixture installed with KTSL-FC2-12V-SM-PIR

ORDERING INFORMATION

Catalog Number	Pack Quantity	Easy Code	UPC
KT-RKIT24PS-22DB-8CSA-VDIM	TBD	SDN-56	843654134819

CATALOG NUMBER BREAKDOWN

KT-RKIT24PS-22DB-8CSA-VDIM

- 1
- 2
- 3
- 4
- 5
- 6
- 7
- 8
- 9
- 10
- 11

- 1 Keystone Technologies
- 2 Retrofit Kit
- 3 Wattage
- 4 Power Select
- 5 2X2' Nominal Length
- 6 Lamp Type
- 7 80 CRI
- 8 Color Select
- 9 Color Select Designation
- 10 0-10V Dimming

- 9 Color Select Designation

A	3500K, 4000K, 5000K
---	---------------------

- 11 Sensor Options

	No Option
/FC2-PIR	SmartLoop PIR sensor included