

# KT-RHLED400PS-18C-8CSD-VDIM-P

## ROUND LED HIGH BAY FIXTURE

### DESCRIPTION

Round LED High Bay Fixture | Wet Location Rated | High Temp Rated

### APPLICATION

Used for commercial and industrial High Bay lighting applications



### PRODUCT FEATURES

- High Power Round High Bay, optimized for 40'+ mounting heights and related higher ambient temperatures
- Design features a large spacer between LED driver and the diecast heat sink to optimize thermal performance
- Features Keystone Power Select technology. Adjust power between 400/320/240W, changing lumen output to set high end trim.
- Features Keystone Color Select technology. Adjust CCT between 4000/5000K
- Designed with Keystone's SmartPort receptacle for adding sensors and controls.
- Powered by Keystone 0–10V dimming LED driver
- J-Hook mounting accessory included
- 6' cord for input and dimming wires
- Powder-coated aluminum housing; Polycarbonate lens
- Ribbed lens to reduce glare
- Low optical flicker
- Built-in 6kV surge protection
- LED lifetime: L70 >100,000 hours @ 25°C fixture ambient
- Ambient operating temperature: -40°C/-40°F to 60°C/140°F
- IP65 rated, wet location
- Listed on QPL DLC, Premium

### PERFORMANCE SPECIFICATIONS

Catalog Number	Nominal Size	Selectable Wattage	Selectable CCT	Lumens	Efficacy	Input Voltage	Dimmable	DLC	CRI	Housing Color
KT-RHLED400PS-18C-8CSD-VDIM-P	18"	400W	4000K	58500	146 lm/W	120–277V	0–10V	Yes	>80	Black
			5000K	59000	147 lm/W					
		320W	4000K	49500	155 lm/W					
			5000K	50000	156 lm/W					
		240W	4000K	38000	158 lm/W					
			5000K	38500	160 lm/W					

Note: Preset to highest lumen output (400W/5000K)

Note: Color uniformity: CCT (Correlated Color Temperature) range as per guidelines outlined in ANSI C78.377-2017

### PHOTOMETRIC SPECIFICATIONS

#### ISOCANDELA PLOT

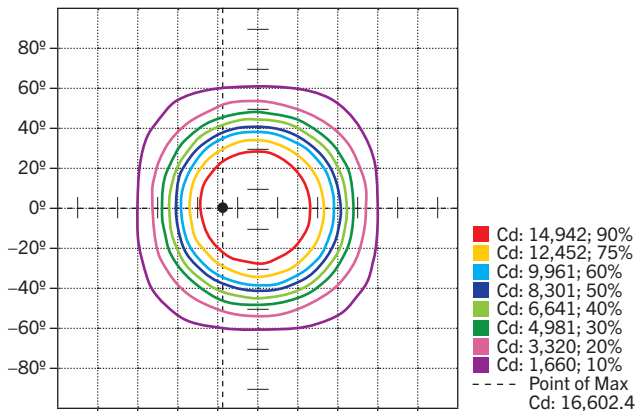

#### POLAR CANDELA DISTRIBUTION

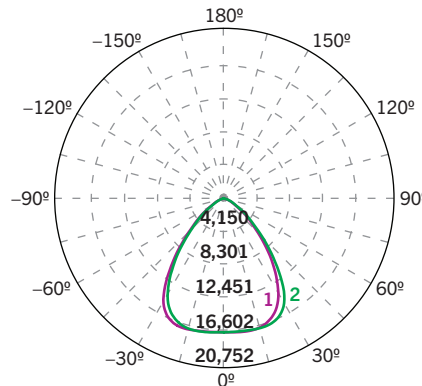

#### ZONAL LUMEN SUMMARY

Zone	Lumens	% Luminaire
0–30	13,328.7	44.2%
0–40	20,615.9	68.4%
0–60	28,188.7	93.6%
60–90	1,897.0	6.3%
70–100	612.8	2.0%
90–120	0.2	0%
0–90	30,085.7	99.8%
90–180	45.2	0.2%
0–180	30,130.9	100%

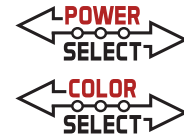

# KT-RHLED400PS-18C-8CSD-VDIM-P

## ROUND LED HIGH BAY FIXTURE

### PHYSICAL SPECIFICATIONS

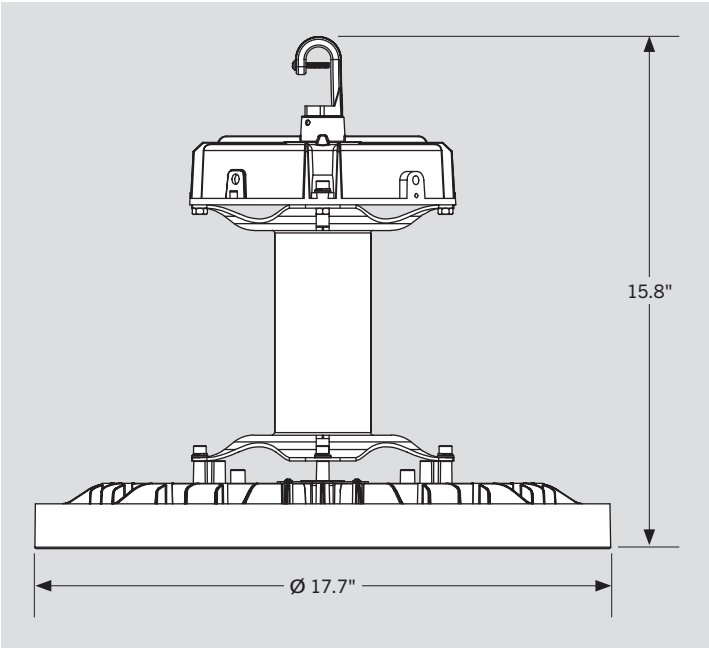

### POWER SELECTION AND CCT SELECTION CAPABILITY

**KEYSTONE COLOR SELECT TECHNOLOGY**  
Adjust CCT between 4000/5000K

**KEYSTONE POWER SELECT TECHNOLOGY**  
Adjust power between 400/320/240W

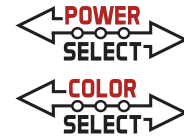

# KT-RHLED400PS-18C-8CSD-VDIM-P

## ROUND LED HIGH BAY FIXTURE

### QUICK-INSTALL

1. Ensure power is off to the fixture.
2. Remove 1/2" knock-out (KO) plug.
3. Screw in sensor head.  
(see illustrations)
4. Re-connect power when ready.
5. Program desired settings as needed with Keystone Remote Control.

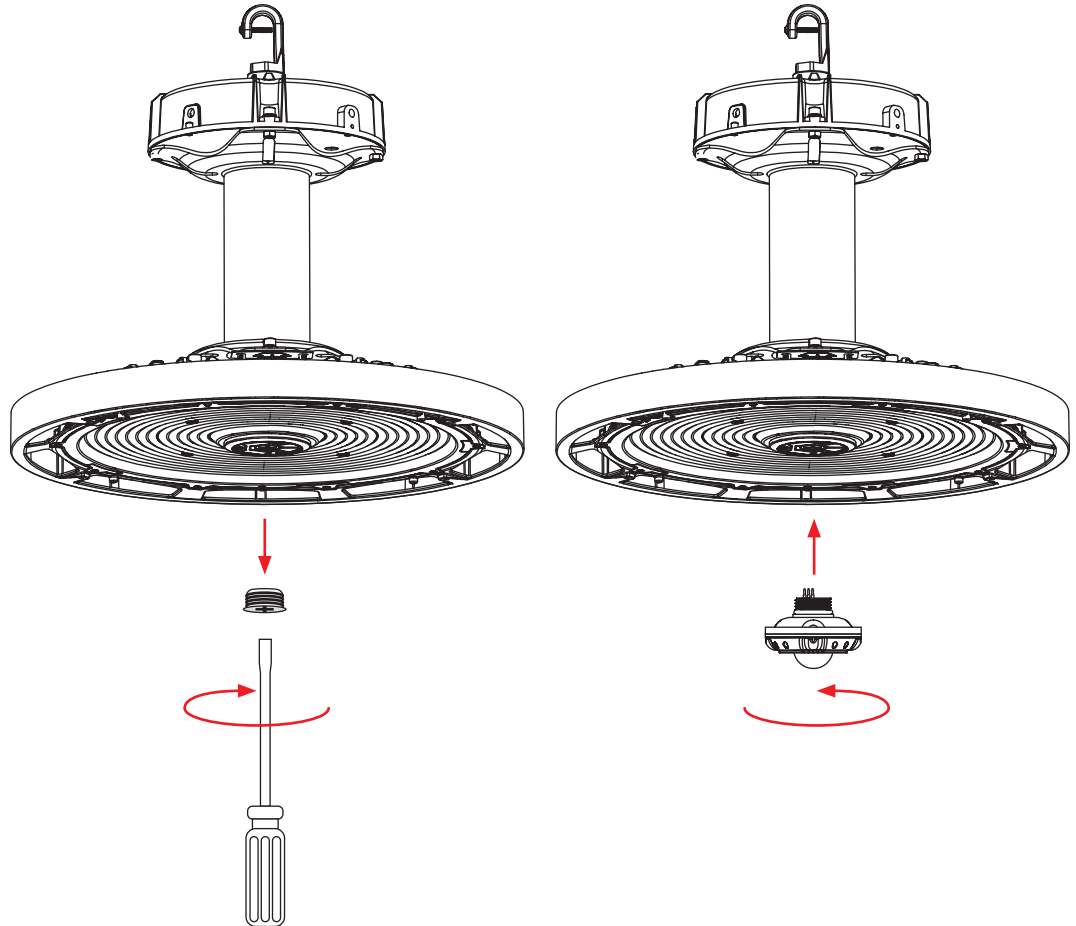

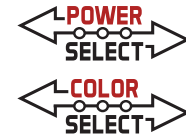



# KT-RHLED400PS-18C-8CSD-VDIM-P

## ROUND LED HIGH BAY FIXTURE

**ACCESSORIES**

**SENSORS**

Factory-Installable OR Field-Installable (field-installable purchased separately)

✓	SUFFIX*	CATALOG NUMBER	DESCRIPTION	UPC	EASY CODE
	/FC3	KTSL-FC3-12V-PKO-PIR	Bluetooth mesh wireless screw-in low voltage PIR motion sensor and fixture controller for SmartLoop system; with daylight detection 	843654138862	OCW-60
	/FC4	KTSL-FC4-12V-PKO	Bluetooth mesh wireless screw-in low voltage fixture controller for SmartLoop system 	843654149066	RUN-10
	/PIR3	KTS-PIR3-12V-PKO /G2	Screw-in PIR motion sensor with daylight detection; Adjustable settings via remote control commissioning	843654146447	GLF-99
	/MW3-A	KTS-MW3-12V-PKO /A	Screw-in microwave motion sensor with daylight detection; Preset for 1 min hold time, 3 min standby time at 30% dim, daylight disabled. Adjustable settings via remote control commissioning	843654133317	XYR-25
	/MW3-B	KTS-MW3-12V-PKO /B	Screw-in microwave motion sensor with daylight detection; Preset for 5 min hold time, 10 min standby time at 10% dim, daylight disabled Adjustable settings via remote control commissioning	843654133324	SPF-37



\* For factory installation of accessory, add suffix to fixture part number (see ordering examples and instructions on last page of spec sheet).

Field-Installable / Field-Use ONLY (purchased separately)

CATALOG NUMBER	DESCRIPTION	UPC	EASY CODE
KTS-MW3-REMOTECONTROL	Remote control for KTS-MW3-12V-PKO /A or /B and KTS-PIR3-12V-PKO /G2 sensors. Used to set and adjust all sensor settings	843654132020	XSR-61

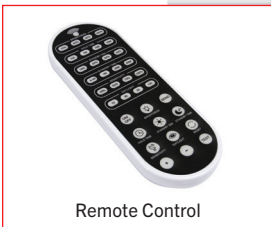

(Accessories continued on next page)

**KT-RHLED400PS-18C-8CSD-VDIM-P**  
ROUND LED HIGH BAY FIXTURE

**ACCESSORIES** (continued)

**MOUNTS AND BRACKETS**

Field-Installable / Field-Use ONLY (purchased separately)

CATALOG NUMBER	DESCRIPTION	UPC	EASY CODE
KT-RHLED-SM-3-KIT /G2	Surface mount kit for round highbay fixtures; Fits 400W round highbay fixture; Includes mounting hardware	843654151755	JGH-39
KT-RHLED-AR90-3-KIT /G2	Aluminum reflector kit for 400W KT-RHLED fixtures; 90-degree beam angle; Includes dome and hardware	843654151748	MIV-43
KT-RHLED-CL90-3-KIT /G2	Clear polycarbonate reflector for 400W round highbay fixtures; 90-degree beam angle; Includes dome, bottom lens, and hardware	843654151779	DPW-30
KT-RHLED-WG-3-KIT /G2	Wire guard kit for round highbay fixtures; Fits 400W round highbay fixture; Includes mounting hardware	843654151762	DHU-26
KT-RHLED-JBOX-PM /G2	J-Box; Optimized for pole pendant and step down transformer applications; Fits all round LED high bay fixtures	843654133300	RAQ-94

 <p>Surface Mount Kit KT-RHLED-SM-3-KIT /G2</p>	 <p>Aluminum Reflector Kit KT-RHLED-AR90-3-KIT /G2</p>
 <p>Wire Guard Kit KT-RHLED-WG-3-KIT /G2</p>	 <p>Clear Polycarbonate Reflector KT-RHLED-CL90-3-KIT /G2</p>
 <p>J-Box KT-RHLED-JBOX-PM /G2</p>	

(Accessories continued on next page)

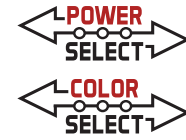

# KT-RHLED400PS-18C-8CSD-VDIM-P

## ROUND LED HIGH BAY FIXTURE

**ACCESSORIES** (continued)

**PLUGS**

Factory-Installable OR Field-Installable (field-installable purchased separately)

✓	SUFFIX*	CATALOG NUMBER	DESCRIPTION	UPC	EASY CODE
	/515P	KT-P-515P	125V NEMA 5-15P Plug	TBD	TBD
	/L515P	KT-P-L515P	125V NEMA L5-15P Twist Lock Plug	843654123486	GEW-06
	/L615P	KT-P-L615P	250V NEMA L6-15P Twist Lock Plug	843654138619	VPX-09
	/L715P	KT-P-L715P	277V NEMA L7-15P Twist Lock Plug	843654123493	ETV-78
	/L720P	KT-P-L720P	277V NEMA L7-120P Twist Lock Plug	TBD	TBD

**FIXTURE ORDERING INFORMATION**

ORDER CODE	PACK QTY.	UPC	Easy Code
KT-RHLED400PS-18C-8CSD-VDIM-P	1	843654151731	WBS-26

**FIXTURE CATALOG NUMBER BREAKDOWN**

# KT-RHLED400PS-18C-8CSD-VDIM-P

- |          |                             |           |                         |
|----------|-----------------------------|-----------|-------------------------|
| <b>1</b> | Keystone Technologies       | <b>7</b>  | 80 CRI                  |
| <b>2</b> | Round High Bay Fixture      | <b>8</b>  | ColorSelect Technology  |
| <b>3</b> | LED Technology              | <b>9</b>  | Color Select 4000/5000K |
| <b>4</b> | Wattage                     | <b>10</b> | 0–10V Dimming           |
| <b>5</b> | Power Select 400/320/240W   | <b>11</b> | Premium Series          |
| <b>6</b> | 18" Diameter Circular Shape |           |                         |

**ORDERING EXAMPLES**

FIXTURE WITH MULTIPLE FACTORY-INSTALLED ACCESSORIES\*

**KT-RHLED400PS-18C-8CSD-VDIM-P/FC3/L515P**

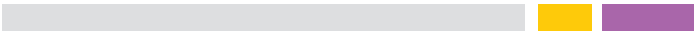

KEYSTONE FIXTURE	
CATALOG NUMBER	
KT-RHLED400PS-18C-8CSD-VDIM-P	

FIXTURE WITH SINGLE FACTORY-INSTALLED ACCESSORY

**KT-RHLED400PS-18C-8CSD-VDIM-P/FC3**

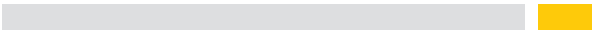

SENSORS		
✓	SUFFIX	CATALOG NUMBER
✓	/FC3	KTSL-FC3-12V-PKO-PIR

FIXTURE WITH NO FACTORY-INSTALLED ACCESSORIES

**KT-RHLED400PS-18C-8CSD-VDIM-P**

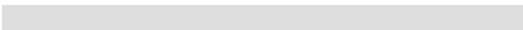

PLUGS		
✓	SUFFIX	CATALOG NUMBER
✓	/L515P	KT-P-L515P

\* When ordering more than one factory-installed accessory, use multiple suffixes as shown in the ordering examples above.  
 Note: All accessories can also be ordered separately for field installation using just their regular Catalog Number, UPC, or Easy Code.