

KT-RDLED16PS-4B-9CSF-VDIM

4" LED RECESSED DOWNLIGHT

DESCRIPTION

4" LED Recessed Downlight | Power Select Technology | Color Select Technology | Remote Driver with Built-in Junction Box

APPLICATION

Ideal for residential, hospitality, retail, office, and other retrofit and new construction applications

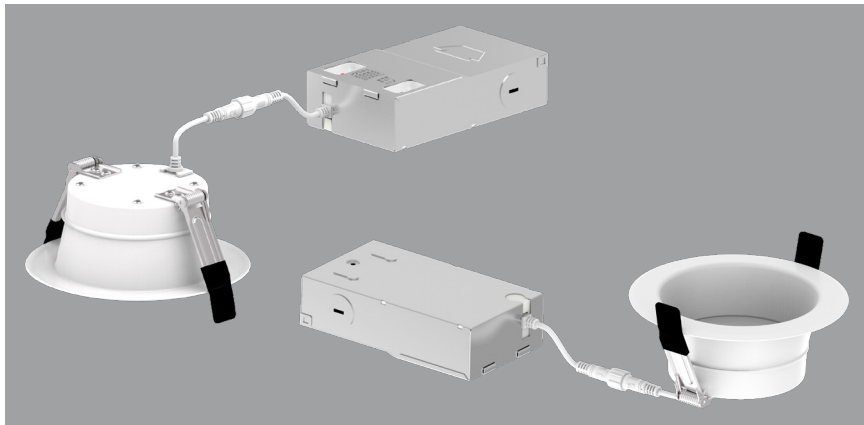

PRODUCT FEATURES

- Keystone Power Select and Color Select technologies offer SKU reduction and allow for easy, on-the-job adjustments
- Utilizes a remote driver with built-in junction box and quick disconnect; Eliminates the need for a traditional, multi-piece fixture setup
- CEC Compliant Flicker Rate (CEC JA10 std.)
- Ideal for new construction, remodel, and retrofit applications
- Frosted lens provides even illumination
- Interchangeable trims available in matte black, brushed nickel, and bronze
- Powered by Keystone 0–10V dimming LED driver; 10–100% dimming
- Ambient operating temperature: –30°C/–22°F to 40°C/104°F
- Suitable for use in wet locations
- Airtight and Type IC-rated
- Power factor: >0.90
- THD: <20%
- LED chip lifetime: L70 >80,000 hrs @ 25°C/77°F ambient fixture temp
- FCC Part 15, Subpart B, Class A

PERFORMANCE SPECIFICATIONS

Catalog Number	Input Voltage	Wattage (Selectable)	CCT (Selectable)*	Lumen Output	Efficacy	CRI	Power Factor	Beam Angle	Lifetime
KT-RDLED16PS-4B-9CSF-VDIM	120–277V	16W	2700K	1,400	88 lm/W	>90	>0.9	80°	50,000 hrs
			3000K	1,430	89 lm/W				
			3500K	1,460	91 lm/W				
			4000K	1,460	91 lm/W				
			5000K	1,430	89 lm/W				
		11W	2700K	950	86 lm/W				
			3000K	970	88 lm/W				
			3500K	990	90 lm/W				
			4000K	990	90 lm/W				
			5000K	970	88 lm/W				
		7W	2700K	600	86 lm/W				
			3000K	620	89 lm/W				
			3500K	640	91 lm/W				
			4000K	640	91 lm/W				
			5000K	620	89 lm/W				

* Preset to highest CCT: 5000K
Color Uniformity: CCT (Correlated Color Temperature) range as per guidelines outlined in ANSI C78.377-2017

KT-RDLED16PS-4B-9CSF-VDIM

4" LED RECESSED DOWNLIGHT

PHOTOMETRIC SPECIFICATIONS

POLAR CANDELA DISTRIBUTION

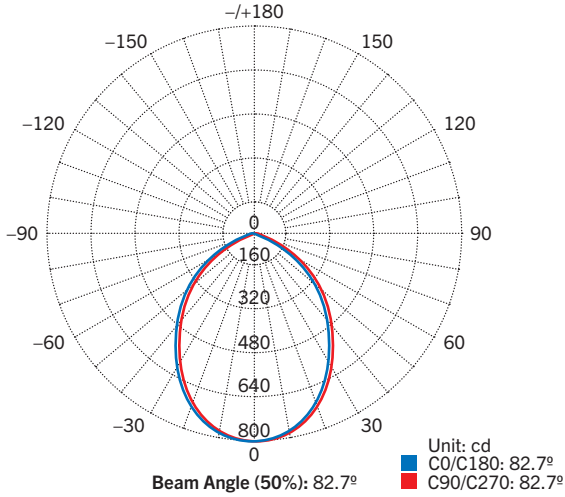

LUX DISTANCE CURVE

Flux Out: 967.1 lm

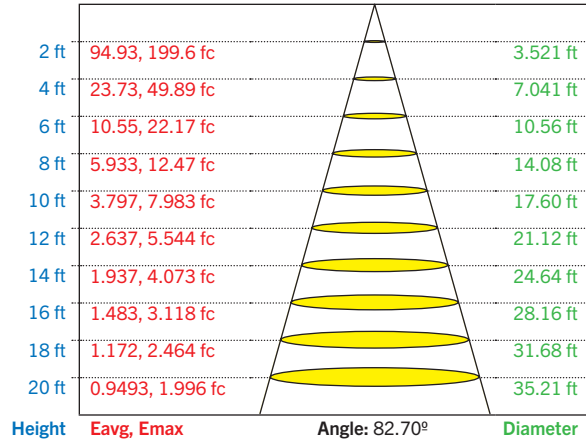

Curves show illuminated area and average illumination when lamp is at various distances.

PHYSICAL SPECIFICATIONS

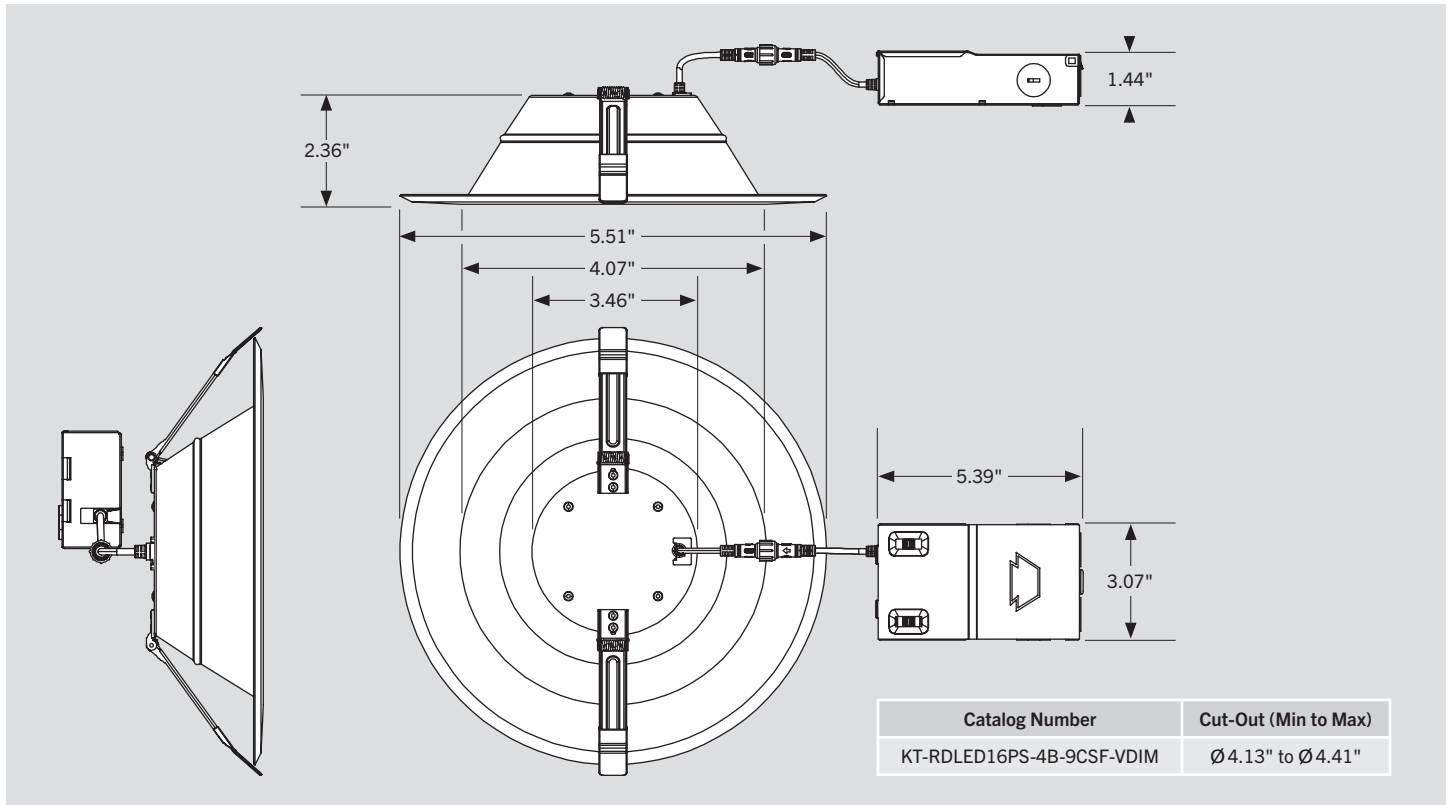

KT-RDLED16PS-4B-9CSF-VDIM 4" LED RECESSED DOWNLIGHT

POWER SELECT (WATTAGE) AND COLOR SELECT (CCT) ADJUSTMENT

This fixture is equipped with field-adjustable Keystone Power Select and Color Select technology.

1. Ensure power is off to the fixture.
2. Adjust dip switches to desired settings.

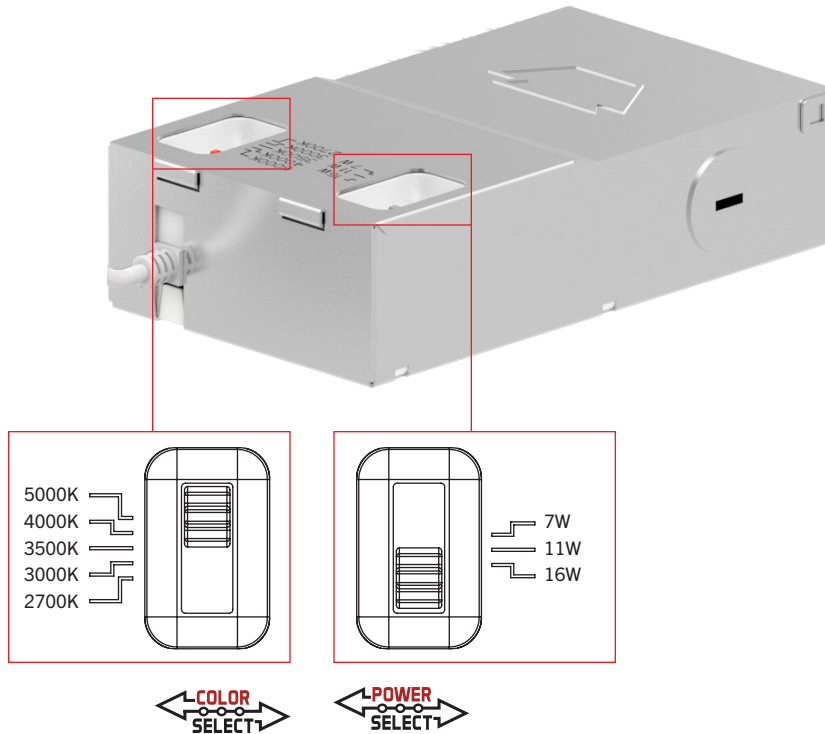

COLOR SELECT ADJUSTMENT SWITCH
Set dip switch to adjust CCT between 2700K, 3000K, 3500K, 4000K, and 5000K. Fixture comes preset at 5000K.

POWER SELECT ADJUSTMENT SWITCH
Set dip switch to adjust wattage between 7W, 11W, and 16W. Fixture comes preset at 16W.

WIRING DIAGRAM

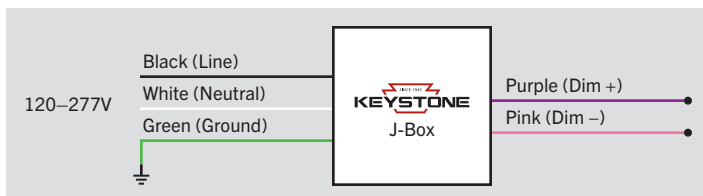

KT-RDLED16PS-4B-9CSF-VDIM 4" LED RECESSED DOWNLIGHT

INSTALLATION INSTRUCTIONS

RETROFIT INSTALLATION

- 1. Shut off power at the source of the fixture housing into which you are installing fixture.**

Remove existing trim, CFL or incandescent bulb.

Note: Follow all federal and local regulations when disposing of lamps and removed components.

- 2. Measure ceiling opening to ensure that the edge of the luminaire will cover the entire opening and still sit firmly in the ceiling (see *Dimensions* on page 2).**

- 3. Select desired Wattage and CCT using adjustment switches on fixture (see *Power Select (Wattage) and Color Select (CCT) Adjustment* on page 3).**

- 4. Open the driver box and remove the knockout(s) (KO).**

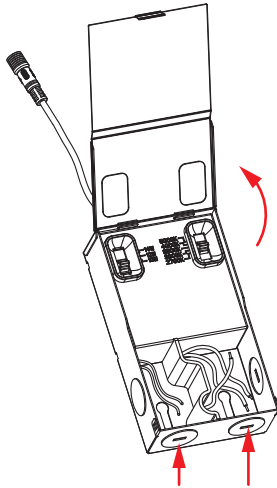

- 5. Insert the electrical supply cable through the KO; use appropriate bushing to prevent wire abrasion. Wire driver box (see *Wiring Diagram* on page 3 and illustration below).***

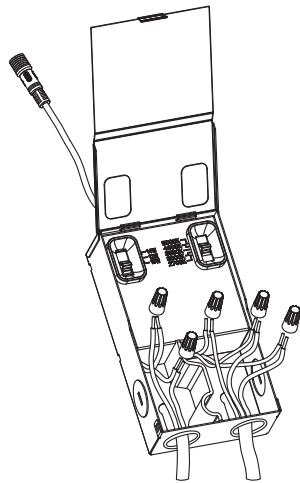

- 6. Place all wiring and connections back into the box and close the cover.**

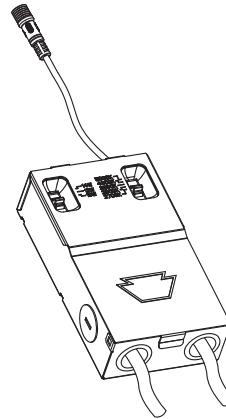

- 7. Insert driver box into ceiling in accordance with local/national codes and connect the male and female connectors. Screw threaded nut over connectors to secure.**

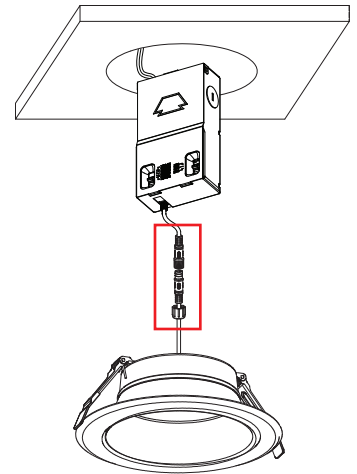

- 8. Lifting both retention tabs upward, push the fixture into the hole until trim sits flush with ceiling.**

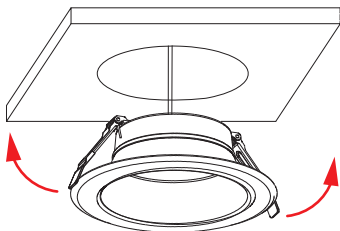

- 9. Restore power when ready.**

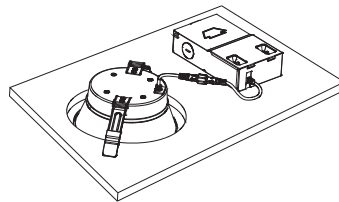

* Keystone offers an optional cable accessory to assist with wiring to existing fixture J-box. See *KT-MC-NP-1-18/3, Optional Accessories (sold separately)* on page 6.

(Installation Instructions continued on next page)

KT-RDLED16PS-4B-9CSF-VDIM 4" LED RECESSED DOWNLIGHT

INSTALLATION INSTRUCTIONS (continued)

NEW-CONSTRUCTION INSTALLATION*

1. Shut off power at the source of the fixture housing into which you are installing fixture.
2. Using installation hole template, create ceiling opening to ensure that the edge of the luminaire will cover the entire opening and still sit firmly in the ceiling (see Dimensions on page 2).
3. Select desired Wattage and CCT using adjustment switches on fixture (see *Power Select (Wattage) and Color Select (CCT) Adjustment* on page 3).

4. Open the driver box and remove the knockout(s) (KO).

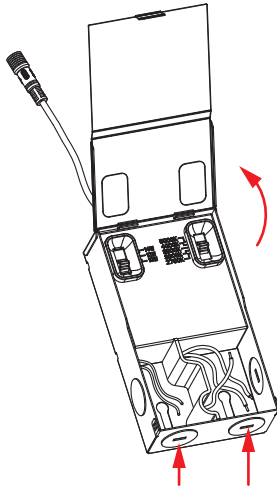

5. Insert the electrical supply cable through the KO; use appropriate bushing to prevent wire abrasion. Wire driver box (see *Wiring Diagram* on page 3 and illustration below).*

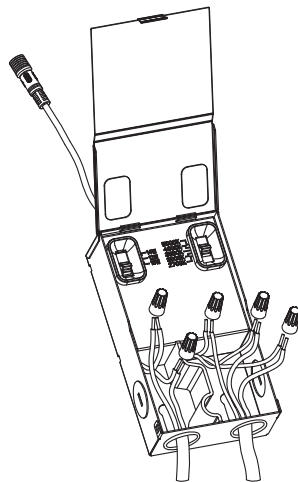

6. Place all wiring and connections back into the box and close the cover.

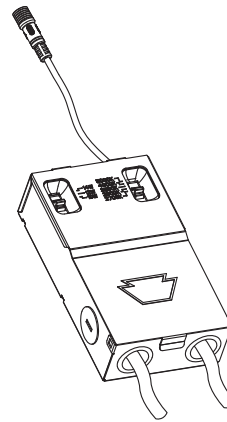

7. Insert driver box into ceiling in accordance with local/national codes and connect the male and female connectors. Screw threaded nut over connectors to secure.

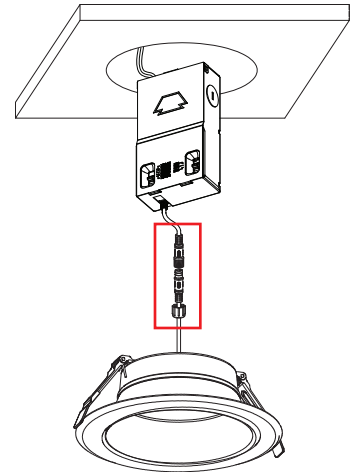

8. Lifting both retention tabs upward, push the fixture into the hole until trim sits flush with ceiling.

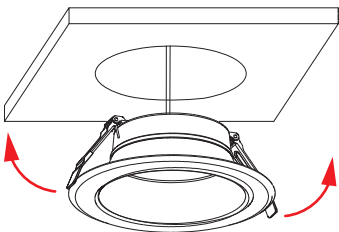

9. Restore power when ready.

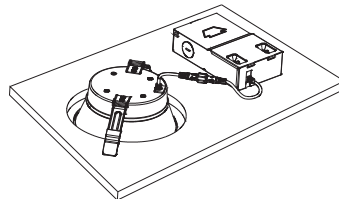

* Keystone offers an optional cable accessory to assist with wiring to existing fixture J-box. See *KT-MC-NP-1-18/3, Optional Accessories (sold separately)* on page 6.

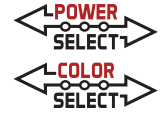

KT-RDLED16PS-4B-9CSF-VDIM

4" LED RECESSED DOWNLIGHT

OPTIONAL ACCESSORIES (sold separately)

INTERCHANGEABLE TRIM

Catalog Number	Description	UPC	Easy Code
KT-RDLED-4B-MB-TRIM	4" Interchangeable Trim for 4B Recessed Downlight; Matte Black	843654139517	BVY-42
KT-RDLED-4B-BN-TRIM	4" Interchangeable Trim for 4B Recessed Downlight; Brushed Nickel	843654139555	SJB-19
KT-RDLED-4B-BR-TRIM	4" Interchangeable Trim for 4B Recessed Downlight; Bronze	843654139593	PFU-34

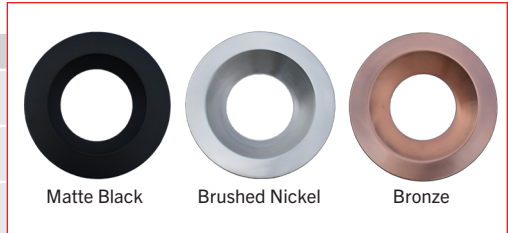

GOOF RING

Catalog Number	Description	UPC	Easy Code
KT-RDLED-4B-GOOF	4" Goof Ring for 4B Recessed Downlights; 6" outer diameter	843654139685	FOA-18

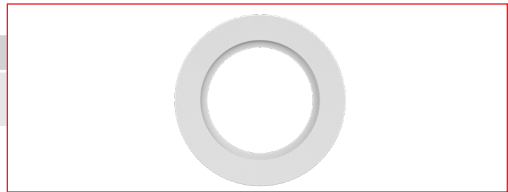

NEW-CONSTRUCTION PLATE

Catalog Number	Description	UPC	Easy Code
KT-RDLED-PLATE-1	New-construction plate for LED Recessed Downlights	843654137285	BMS-81

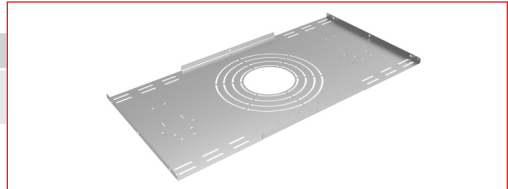

EXTENSION CABLES

Catalog Number	Description	UPC	Easy Code
KT-WDLED-EC-6	6' Extension Cord for LED Recessed Downlights	843654139739	GOK-14
KT-WDLED-EC-12	12' Extension Cord for LED Recessed Downlights	843654139746	ECE-88
KT-WDLED-EC-20	20' Extension Cord for LED Recessed Downlights	843654139753	JLM-06

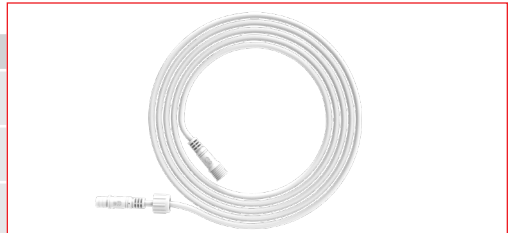

METAL-CLAD CABLE

Catalog Number	Description	UPC	Easy Code
KT-MC-NP-1-18/3	Metal-Clad Cable for LED Recessed Downlights; No plug; UL 16AWG 18/3 wire (live, neutral, ground)	843654139777	AYT-71



EMERGENCY PACK

Catalog Number	Description	UPC	Easy Code
KT-EMRG-LED-12-1200-AC /DF	LED Emergency Backup, 12W - 1200 Lumen Constant Power Design. 120-277V Input. Dual Flex Cable Design. Installs on Primary Side of AC Powered LED load.	843654139890	MPM-43



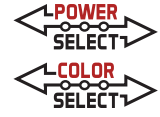

KT-RDLED16PS-4B-9CSF-VDIM

4" LED RECESSED DOWNLIGHT

ORDERING INFORMATION

Catalog Number	Pack Qty.	UPC	Easy Code
KT-RDLED16PS-4B-9CSF-VDIM	1	843654139265	ZBD-42

CATALOG NUMBER BREAKDOWN

KT-RDLED16PS-4B-9CSF-VDIM

- 1
- 2
- 3
- 4
- 5
- 6
- 7
- 8
- 9
- 10
- 11

- 1 Keystone Technologies
- 2 Fixture Type
- 3 LED Technology
- 4 Maximum Wattage
- 5 Power Select Technology
- 6 Size
- 7 Style/Design Designation
- 8 CRI
- 9 Color Select Technology
- 10 Color Select Designation
- 11 Dimming

2 Fixture Type	6 Size	7 Style/Design Designation
RD Recessed Downlight	4 4" Nominal	B Series B
8 CRI	10 Color Select Designation	11 Dimming
9 90	F 2700K, 3000K, 3500K, 4000K, 5000K	VDIM 0-10V Dimming