



KT-LED82P-V-8CSE-D

2-PIN LED LAMP

DESCRIPTION

8.5W 2-Pin LED Lamp | Color Select 3000/3500/4000K | ≥82 CRI



RoHS
Compliant



5 YEAR
WARRANTY

LAMP TYPE: Compact
BULB TYPE: 2-Pin LED
BASE TYPE: G24d
WATTAGE: 8.5W
SELECTABLE COLOR TEMPERATURE: 3000/3500/4000K
COLOR RENDERING INDEX (CRI): ≥82
WARRANTY: 5 Years



PRODUCT FEATURES

- ****G24D 2-pin can be used in G24Q 4-pin applications for ballast bypass****
- Save 50% on energy consumption compared to typical CFL bulbs
- Extend useful life four times (50,000 hours)
- Environmentally friendly: no mercury used
- Frosted lens eliminates pixelation
- Not for use in enclosed fixtures

- Operating temperature: -20°C/-4°F to 45°C/113°F
- Simplifies installation without the need for an external driver or ballast
- Instant startup
- Suitable for use in dry and damp locations
- UL Classified
- Rotatable 270°

OPERATING SPECIFICATIONS

ELECTRICAL CHARACTERISTICS

Input Voltage	Lamp Wattage	Power Factor	System Wattage
120-277V	8.5W	>0.9	8.5W

PHOTOMETRIC CHARACTERISTICS

Color Temperature (CCT)	3000K*	3500K	4000K
Luminous Flux	1100	1120	1150
Color Rendering Index (CRI)	≥82	≥82	≥82
Bare Lamp Efficacy	129	132	135

*Preset to 3000K

RATED LIFE

L70 (Hours)	50,000
-------------	--------

POLAR CANDELA DISTRIBUTION

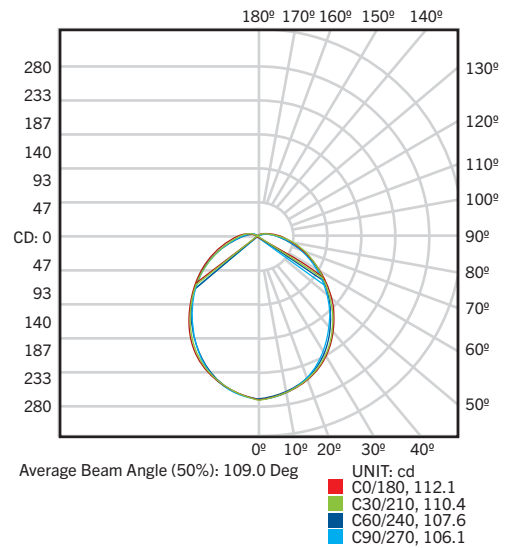



KT-LED82P-V-8CSE-D

2-PIN LED LAMP

WIRING

BYPASS MAGNETIC BALLAST WITH 1 LAMP

BEFORE

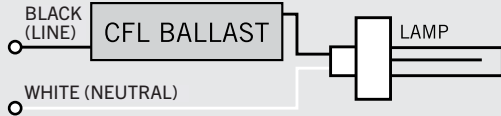

AFTER

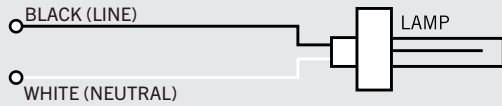

BYPASS ELECTRONIC BALLAST WITH 1 LAMP

BEFORE

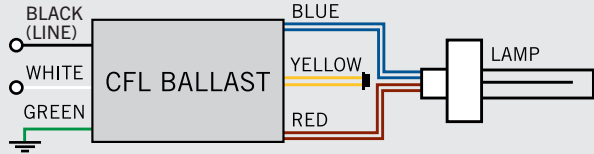

AFTER

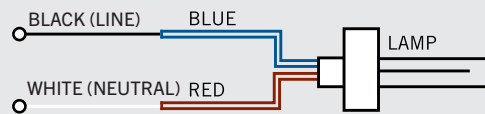

BYPASS MAGNETIC BALLAST WITH 2 LAMPS

BEFORE

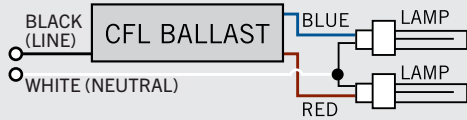

AFTER

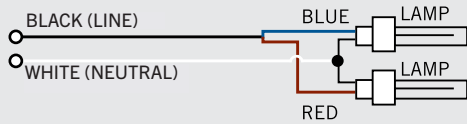

BYPASS ELECTRONIC BALLAST WITH 2 LAMPS

BEFORE

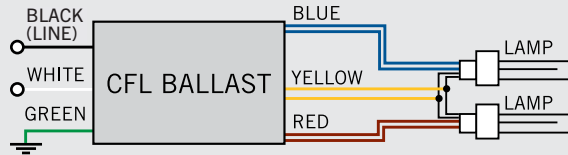

AFTER

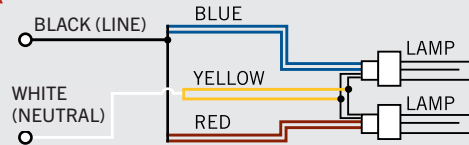

PHYSICAL CHARACTERISTICS

LAMP DIMENSIONS

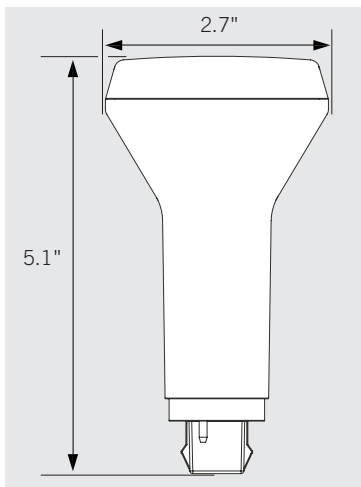



KT-LED82P-V-8CSE-D

2-PIN LED LAMP

ORDERING INFORMATION

ORDER CODE	PACK QTY.	UPC	EASY CODE
KT-LED82P-V-8CSE-D	24	843654137698	XOY-00

CATALOG NUMBER BREAKDOWN

KT-LED82P-V-8CSE-D

- 1
- 2
- 3
- 4
- 5
- 6
- 7
- 8
- 9

- 1 Keystone Technologies
- 2 LED Lamp
- 3 Wattage
- 4 2-Pin Lamp Type
- 5 Vertical Orientation
- 6 80 CRI
- 7 Color Select
- 8 Color Select Designation
- 9 Direct Drive Series

8 Color Select Designation

E 3000/3500/4000K