



# KT-LED63PSHID-EX39-8XX-D /G4

## HID REPLACEMENT LED LAMP

### DESCRIPTION

63W HID Replacement LED Lamp | Power Select | 80 CRI | IP64



<b>LAMP TYPE:</b> HID Replacement LED
<b>BASE TYPE:</b> EX39 (Mogul)
<b>SELECTABLE WATTAGE:</b> 63W, 54W, 45W
<b>COLOR TEMPERATURE:</b> 3000K, 4000K, 5000K
<b>METAL HALIDE EQUIVALENT:</b> 250W
<b>COLOR RENDERING INDEX (CRI):</b> > 80
<b>WARRANTY:</b> 5 Years

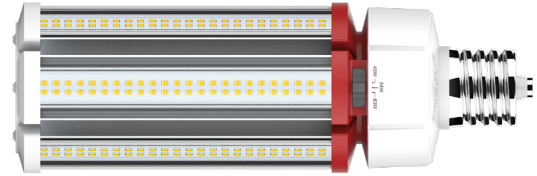

### PRODUCT FEATURES

- Replacement for conventional metal halide lamp
- Environmentally friendly: No mercury used
- Instant startup
- Integral driver eliminates the need for external driver or ballast; includes 4kV surge protection
- Step dimmable with Power Select Switch. See below image.
- 50,000 + hour lifetime
- Operating temperature: -30°C/-22°F to 45°C/113°F
- Suitable for use in fully enclosed fixtures
- Minimum lamp compartment dimensions: 8.0" x 8.0" x 10.0"
- UL listed
- IP64 rated; integrated heat sink quickly dissipates heat and guides water intrusion out of the lamp

### ELECTRICAL AND PERFORMANCE SPECIFICATIONS

Keystone Catalog Number	Input Voltage	Selectable Power	CCT	Lumens	Efficacy	Base Type	CRI	PF
KT-LED63PSHID-EX39-830-D /G4	120-277V	63W	3000K	8505	135 lm/W	EX39	>80	≥90
		54W		7290	135 lm/W			
		45W		6075	135 lm/W			
KT-LED63PSHID-EX39-840-D /G4	120-277V	63W	4000K	8820	140 lm/W	EX39	>80	≥90
		54W		7560	140 lm/W			
		45W		6300	140 lm/W			
KT-LED63PSHID-EX39-850-D /G4	120-277V	63W	5000K	9135	145 lm/W	EX39	>80	≥90
		54W		7830	145 lm/W			
		45W		6525	145 lm/W			

### SELECTABILITY

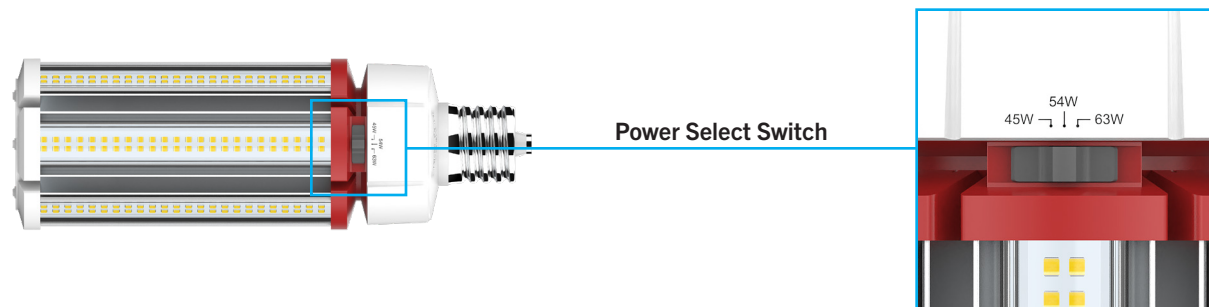



# KT-LED63PSHID-EX39-8XX-D /G4

## HID REPLACEMENT LED LAMP

### PHYSICAL CHARACTERISTICS

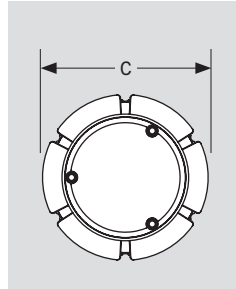
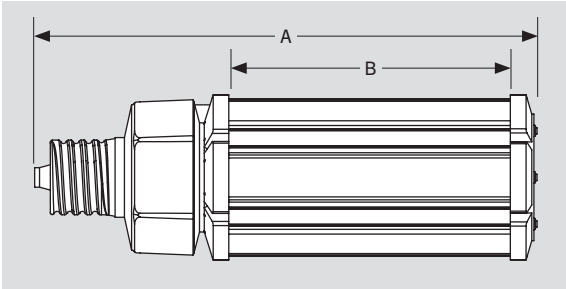

### LAMP DIMENSIONS

A (Body Length)	10.08"
B (Illuminated Length)	6.18"
C (Diameter)	3.35"

BASE TYPE: EX39 (Mogul)

### WIRING INSTRUCTIONS

#### STEP 1

**Disconnect power.** Disconnect and remove existing ballast, capacitor, and/or ignitor (where applicable) from fixture.

*Note:* Follow all federal and local regulations when disposing of lamps and removed components.

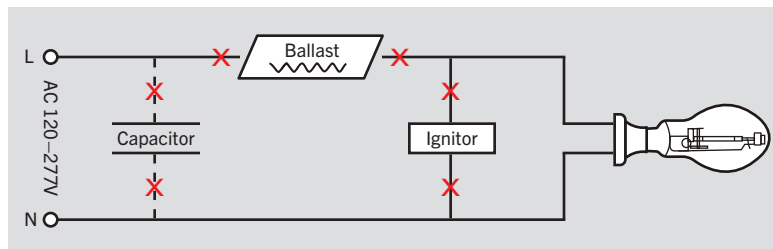

#### STEP 2

Rewire for line voltage to the lamp socket.

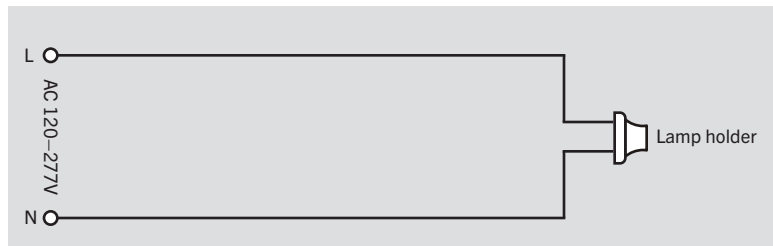

#### STEP 3

Install new LED replacement lamp. Ensure lamp is operating properly when power is turned on.

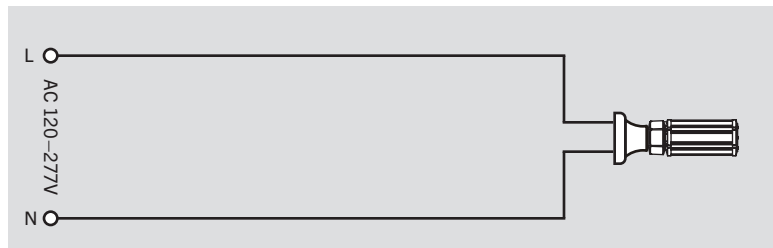
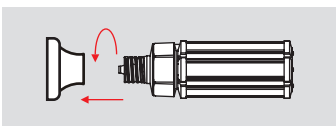

**EX39-based lamps** will work in *both* **E39** and **EX39** sockets.

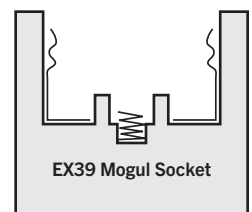
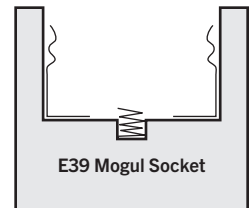



# KT-LED63PSHID-EX39-8XX-D /G4

## HID REPLACEMENT LED LAMP

### ORDERING INFORMATION

ORDER CODE	PACK QTY.	UPC	EASY CODE
KT-LED63PSHID-EX39-830-D /G4	16	843654138367	ABC-55
KT-LED63PSHID-EX39-840-D /G4	16	843654138374	HMK-43
KT-LED63PSHID-EX39-850-D /G4	16	843654138381	IXS-40

### CATALOG NUMBER BREAKDOWN

# KT-LED63PSHID-EX39-8XX-D /G4

1 2 3 4 5 6 7 8 9 10

- 1 Keystone Technologies
- 2 LED Lamp
- 3 Wattage
- 4 Power Select
- 5 Lamp Type
- 6 Base Type
- 7 80 CRI
- 8 Color Temperature
- 9 Direct Drive
- 10 Fourth Generation