

LED45PSHID-H-E26-8CSB-D

HORIZONTAL HID POWER AND COLOR SELECT LED LAMP

DESCRIPTION

45W HID Replacement LED Lamp Designed for Horizontal Applications
 Power Select | Color Select | 80 CRI | IP64



LAMP TYPE: Horizontal HID LED Lamp
BASE TYPE: E26 (Medium) Rotatable
WATTAGE: 45/36/27W
COLOR TEMPERATURE: 3000/4000/5000K
METAL HALIDE EQUIVALENT: 175W
COLOR RENDERING INDEX (CRI): >80
WARRANTY: 5 Years

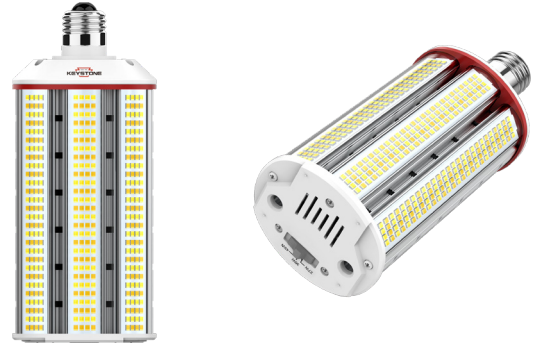

PRODUCT FEATURES

- Replacement for conventional metal halide lamp
- Optimized for horizontal applications, ideal for wall pack retrofits
- Environmentally friendly: No mercury used
- Instant startup
- Integral driver eliminates the need for external driver or legacy ballast; includes 4kV surge protection
- Not for use with standard dimmers; see instructions
- 50,000+ hour lifetime
- Operating temperature: 30°C/-22°F - 45°C/113°F
- Suitable for use in enclosed fixtures
- Minimum lamp compartment dimensions: 8" x 8" x 8.7"
- UL listed
- IP64 rated; integrated heat sink quickly dissipates heat and guides water intrusion out of the lamp

PERFORMANCE SPECIFICATIONS

Catalog Number	Input Voltage	Selectable Power	Selectable CCT	Lumens	Efficacy	Input Voltage	Base	DLC	CRI	Metal Halide Equivalent
KT-LED45PSHID-H-E26-8CSB-D	120-277V	45W	3000K	6525	145 lm/W	120-277V	E26	No	>80	175W MH
			4000K	6975	155 lm/W					
			5000K	6615	147 lm/W					
		36W	3000K	5510	153 lm/W					
			4000K	5725	159 lm/W					
			5000K	5580	155 lm/W					
		27W	3000K	4185	155 lm/W					
			4000K	4345	161 lm/W					
			5000K	4240	157 lm/W					

SELECTABILITY

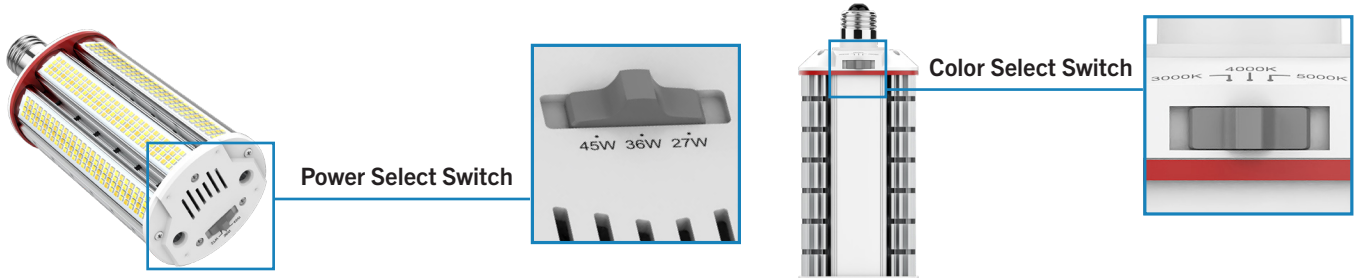

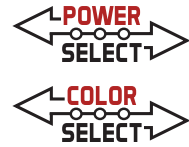

LED45PSHID-H-E26-8CSB-D

HORIZONTAL HID POWER AND COLOR SELECT LED LAMP

PHYSICAL CHARACTERISTICS

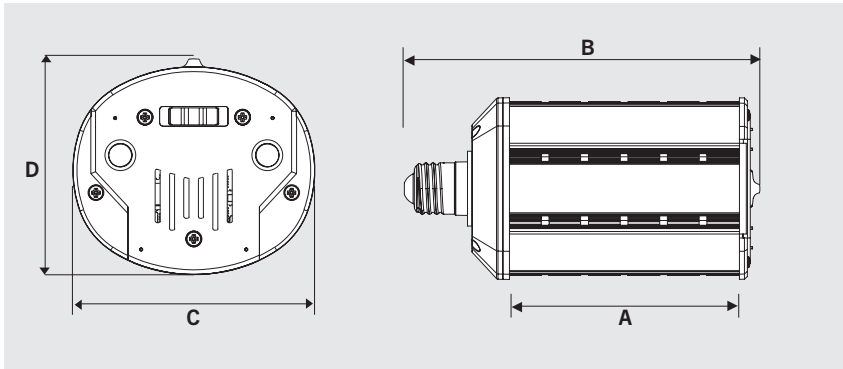

LAMP DIMENSIONS

A (Illuminated Length)	6.18"
B (Body Length)	8.66"
C (Width)	3.62"
D Diameter	3.23"

BASE TYPE: E26 (Medium) Rotatable

WIRING INSTRUCTIONS

STEP 1

Disconnect power. Disconnect and remove existing ballast, capacitor, and/or ignitor (where applicable) from fixture.

STEP 2

Rewire for line voltage to the lamp socket. Lamp is compatible with 120-277V from single phase, three phase wye, and three phase delta systems.

STEP 3

Install new LED replacement lamp. Ensure lamp is operating properly when power is turned on.

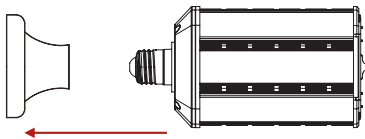

STEP 1

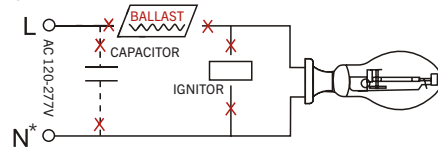

STEP 2

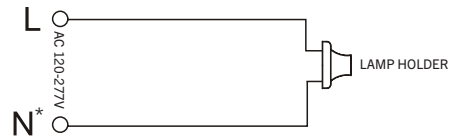

STEP 3

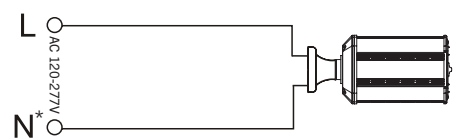

*or other line for certain three phase systems such as 120/208 three phase wye systems

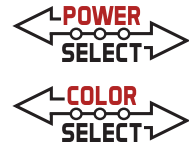

LED45PSHID-H-E26-8CSB-D

HORIZONTAL HID POWER AND COLOR SELECT LED LAMP

ORDERING INFORMATION

ORDER CODE	PACK QTY.	EASY CODE	UPC
LED45PSHID-H-E26-8CSB-D	12	NCU-18	843654138893

CATALOG NUMBER BREAKDOWN

KT-LED45PSHID-H-E26-8CSB-D

1
2
3
4
5
6
7
8
9
10
11

- 1** Keystone Technologies
- 2** LED Lamp
- 3** Max Wattage
- 4** Power Select
- 5** Lamp Type
- 6** Orientation
- 7** Base Type
- 8** 80 CRI
- 9** Color Select
- 10** Color Select Designation
- 11** Direct Drive

10 Color Select Designation

B	3000/4000/5000K
---	-----------------