

KT-LED27PSHID-H-E26-8CSB-D

HORIZONTAL HID POWER AND COLOR SELECT LED LAMP

DESCRIPTION

27W HID Replacement LED Lamp Designed for Horizontal Applications
 Power Select | Color Select | 80 CRI | IP64



LAMP TYPE: Horizontal HID LED Lamp
BASE TYPE: E26 (Medium) Rotatable
WATTAGE: 27/18/12W
COLOR TEMPERATURE: 3000/4000/5000K
METAL HALIDE EQUIVALENT: 100W
COLOR RENDERING INDEX (CRI): >80
WARRANTY: 5 Years

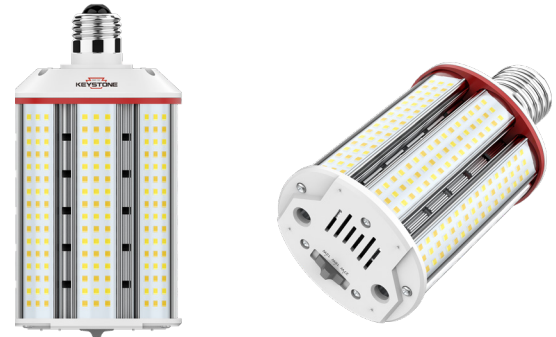

PRODUCT FEATURES

- Replacement for conventional metal halide lamp
- Optimized for horizontal applications, ideal for wall pack retrofits
- Environmentally friendly: No mercury used
- Instant startup
- Integral driver eliminates the need for external driver or legacy ballast; includes 4kV surge protection
- Not for use with standard dimmers; see instructions
- 50,000+ hour lifetime
- Operating temperature: 30°C/-22°F - 45°C/113°F
- Suitable for use in enclosed fixtures
- Minimum lamp compartment dimensions: 8" x 8" x 8.7"
- UL listed
- IP64 rated; integrated heat sink quickly dissipates heat and guides water intrusion out of the lamp

PERFORMANCE SPECIFICATIONS

Catalog Number	Input Voltage	Selectable Power	Selectable CCT	Lumens	Efficacy	Input Voltage	Base	DLC	CRI	Metal Halide Equivalent
KT-LED27PSHID-H-E26-8CSB-D	120-277V	27W	3000K	3995	148 lm/W	120-277V	E26	No	>80	100W MH
			4000K	4240	157 lm/W					
			5000K	4075	151 lm/W					
		18W	3000K	2770	154 lm/W					
			4000K	2880	160 lm/W					
			5000K	2810	156 lm/W					
		12W	3000K	1870	156 lm/W					
			4000K	1945	162 lm/W					
			5000K	1895	158 lm/W					

SELECTABILITY

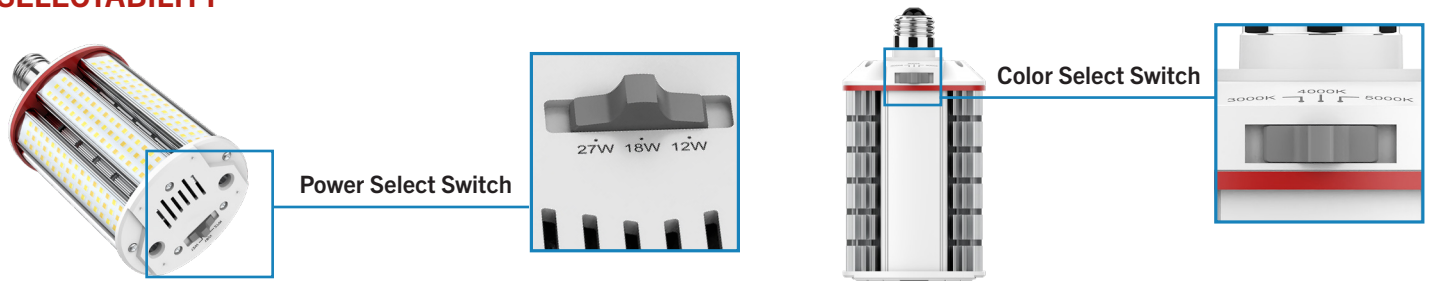

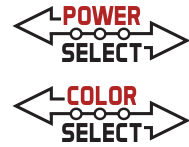

KT-LED27PSHID-H-E26-8CSB-D

HORIZONTAL HID POWER AND COLOR SELECT LED LAMP

PHYSICAL CHARACTERISTICS

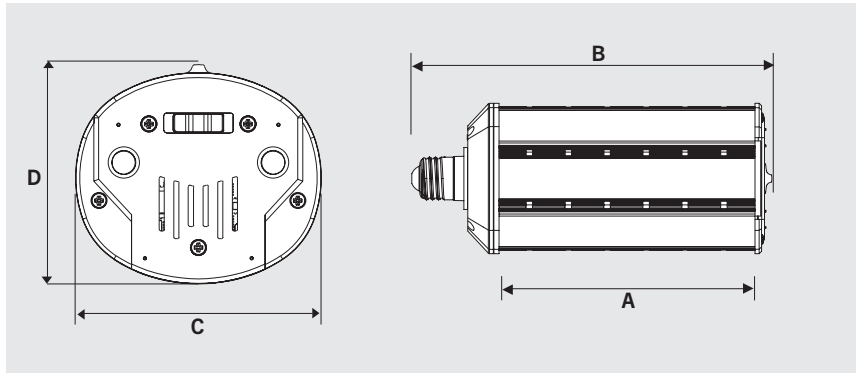

LAMP DIMENSIONS

A (Illuminated Length)	4.61"
B (Body Length)	7.09"
C (Width)	3.62"
D Diameter	3.23"

BASE TYPE: E26 (Medium) Rotatable

WIRING INSTRUCTIONS

STEP 1

Disconnect power. Disconnect and remove existing ballast, capacitor, and/or ignitor (where applicable) from fixture.

STEP 2

Rewire for line voltage to the lamp socket. Lamp is compatible with 120-277V from single phase, three phase wye, and three phase delta systems.

STEP 3

Install new LED replacement lamp. Ensure lamp is operating properly when power is turned on.

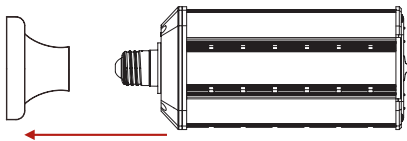

STEP 1

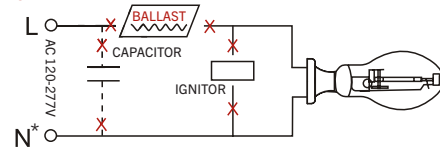

STEP 2

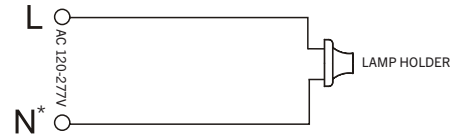

STEP 3

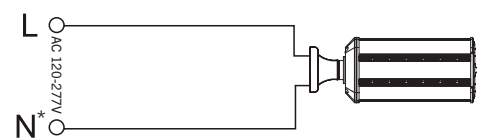

*or other line for certain three phase systems such as 120/208 three phase wye systems

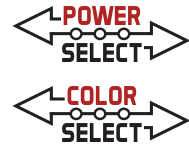

KT-LED27PSHID-H-E26-8CSB-D

HORIZONTAL HID POWER AND COLOR SELECT LED LAMP

ORDERING INFORMATION

ORDER CODE	PACK QTY.	EASY CODE	UPC
KT-LED27PSHID-H-E26-8CSB-D	12	QMC-59	843654138879

CATALOG NUMBER BREAKDOWN

KT-LED27PSHID-H-E26-8CSB-D

1
2
3
4
5
6
7
8
9
10
11

- 1 Keystone Technologies
- 2 LED Lamp
- 3 Max Wattage
- 4 Power Select
- 5 Lamp Type
- 6 Orientation
- 7 Base Type
- 8 80 CRI
- 9 Color Select
- 10 Color Select Designation
- 11 Direct Drive

10 Color Select Designation

B	3000/4000/5000K
---	-----------------