



KT-LED15DL-6CA-9CSF-DIM

6" SURFACE MOUNT DISK LIGHT

DESCRIPTION

6" Circular LED Residential Retrofit Disk Light

APPLICATION

Ideal for residential, hospitality, retail, and other retrofit and new construction applications



PRODUCT FEATURES

- Keystone Color Select technology (2700/3000/3500/4000/5000K)
- Ideal for retrofit, new construction, and remodel applications
- Flush-mount offers clean, modern appearance
- Diffused lens reduces glare
- Powered by Keystone TRIAC dimming LED driver; 10–100% dimming
- Ambient operating temperature: -25°C/-13°F to 40°C/104°F
- Suitable for use in wet locations
- Power factor: > 0.90
- Compliant with FCC Part 15, Subpart B, Class B

PERFORMANCE SPECIFICATIONS

Catalog Number	Input Voltage	Wattage	CCT	Lumen Output	Efficacy	CRI	Beam Angle	Lifetime
KT-LED15DL-6CA-9CSF-DIM	120V	15W	2700K	1000	67	>90	110°	50,000 hrs
			3000K					
			3500K					
			4000K					
			5000K					

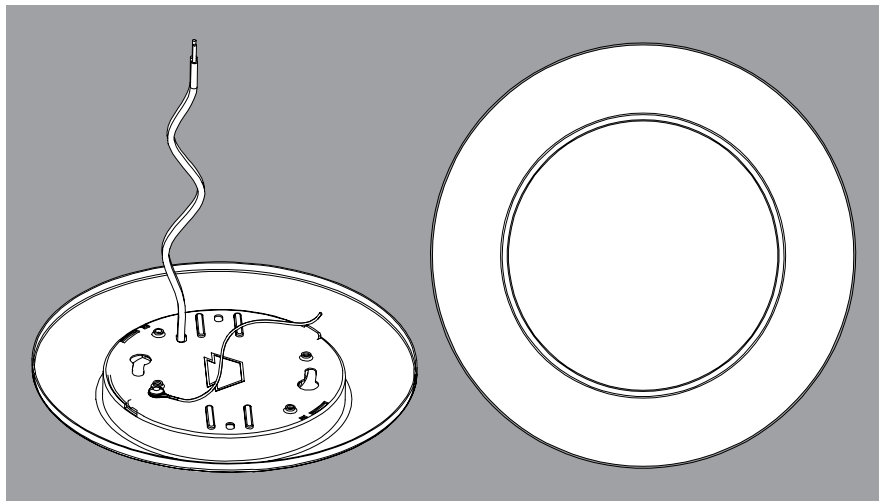

GENERAL WIRING DIAGRAM

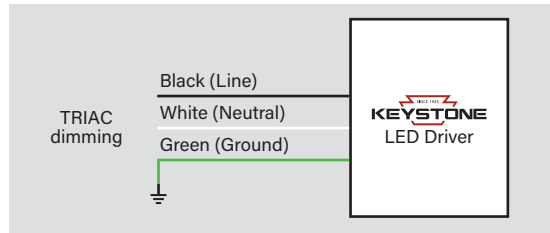

KT-LED15DL-6CA-9CSF-DIM
6" SURFACE MOUNT DISK LIGHT

PHOTOMETRIC SPECIFICATIONS

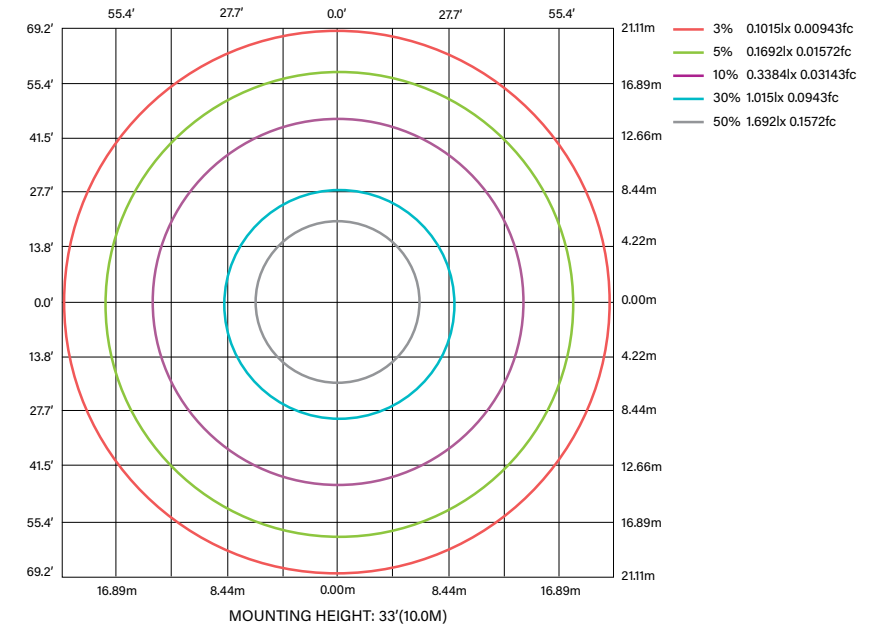
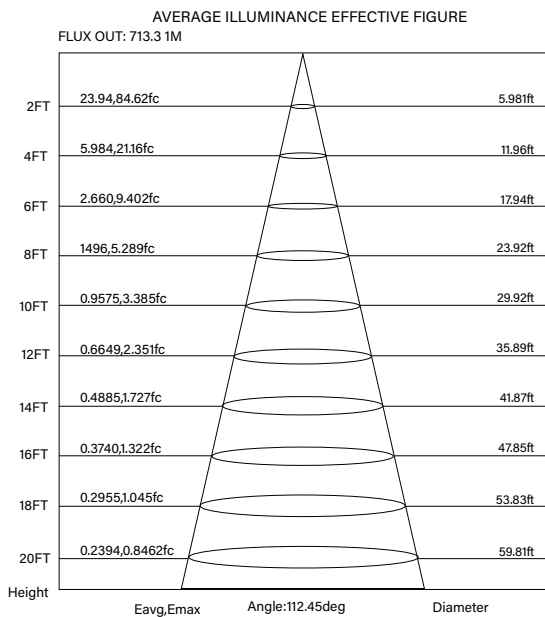
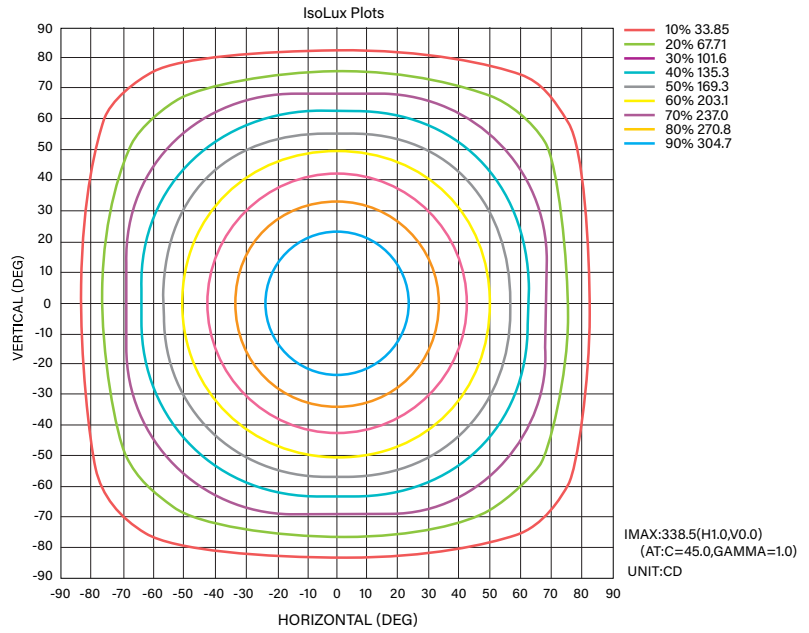
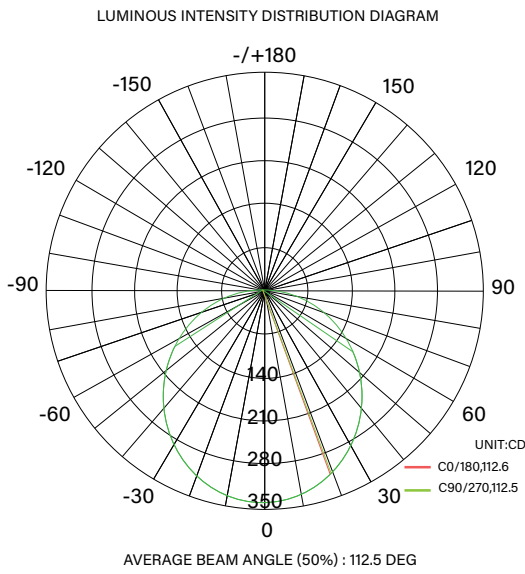

Note: The Curves indicate the illuminated area and the average illumination when the luminaire is at different distance.

KT-LED15DL-6CA-9CSF-DIM
6" SURFACE MOUNT DISK LIGHT

PHYSICAL SPECIFICATIONS

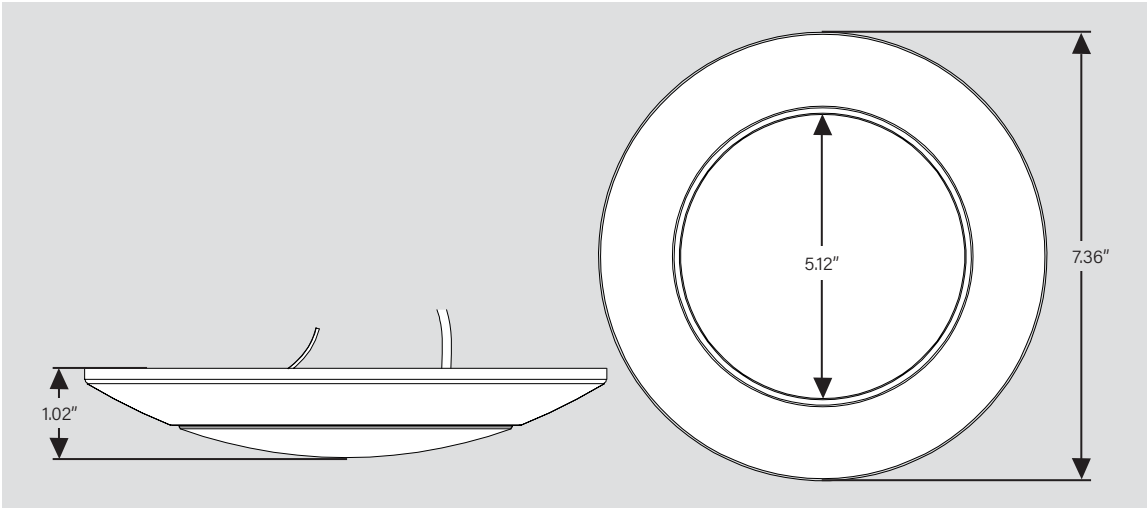

INSTALLATION INSTRUCTIONS

1. Connect the luminaire to supply wires with the wire nuts (included).

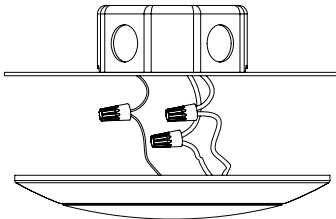

2. Remove lens by turning counter clockwise to unlock.

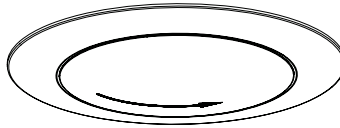

3. Select desired CCT

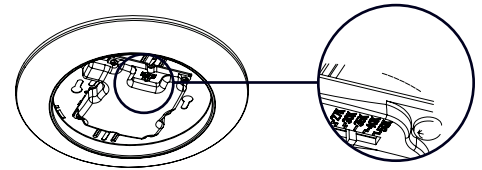

4. Safely place all wires into the junction box, mount luminaire to the junction box and screws through the keyhole slots. 6" luminaires are compatible with either 2.75" or 3.5" junction boxes.

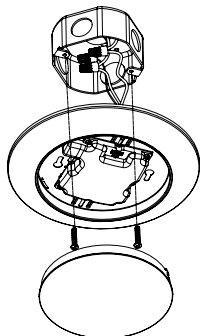

5. Replace lens and twist clockwise to lock.

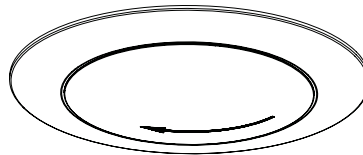



KT-LED15DL-6CA-9CSF-DIM

6" SURFACE MOUNT DISK LIGHT

ORDERING INFORMATION

Catalog Number	UPC	Easy Code	Energy Star Unique ID
KT-LED15DL-6CA-9CSF-DIM	843654156927	IIF-68	2473115

CATALOG NUMBER BREAKDOWN

KT-LED15DL-6CA-9CSF-DIM

1 2 3 4 5 6 7 8 9 10 11

- 1 Keystone Technologies**
- 2 LED Technology**
- 3 Wattage**
- 4 Fixture Type**
 - DL Disk Light
- 5 Nominal Size**
 - 6 6" Nominal
- 6 Shape**
 - C Circular
- 7 Designation**
 - A Series A Design
- 10 Color Select Designation**
 - F 2700/3000/3500/4000/5000K
- 11 Dimming**
 - DIM TRIAC Dimmable