

KT-CBLED45PS-24B-8CSA-VDIM

LED CENTER BASKET FIXTURE

DESCRIPTION

2' x 4' LED Center Basket Fixture | 120–277V Input |
Frosted Lens | 0–10V Dimming

APPLICATION

Used for commercial recessed ceiling applications



PRODUCT FEATURES

- Features Keystone Color Select technology. Adjust CCT between 3500K, 4000K, or 5000K
- Features Keystone Power Select technology. Adjust power between 45W, 38W, and 30W
- Powered by Keystone 0 –10V dimming LED drivers with 12V Aux
- Architectural grade center basket volumetric design
- Ambient operating temperature: -20°C/-4°F to 50°C/122°F
- Compatible with Keystone SmartSafe emergency backups
- Available with optional integral occupancy sensor accessory, KTSL-FC2-12V-SM-PIR
- Low optical flicker
- THD: < 20%
- Power factor > 0.95
- IC Rated

POWER AND COLOR TEMPERATURE SELECTABILITY

- Keystone Color Select Technology: Adjustable CCT (3500K/4000K/5000K)
- Keystone Power Select Technology: Adjustable Wattage (45W/38W/30W)

PRODUCT SPECIFICATIONS

Catalog Number	Input Voltage	Wattage	CCT	Lumen Output	Efficacy	CRI	Power Factor	Lifetime
KT-CBLED45PS-24B-8CSA-VDIM	120–277V	45W	3500K	5,760	128 lm/W	> 80	> 0.90	50,000 hrs
			4000K	5,805	129 lm/W			
			5000K	5,850	130 lm/W			
		38W	3500K	4,978	131 lm/W			
			4000K	5,016	132 lm/W			
			5000K	5,054	133 lm/W			
		30W	3500K	4,110	137 lm/W			
			4000K	4,140	138 lm/W			
			5000K	4,170	139 lm/W			

ONE CATALOG NUMBER WITH 9 DIFFERENT OPTIONS

* Preset to highest lumen output (45W / 5000K)
* Color Uniformity: CCT (Correlated Color Temperature) range as per guidelines outlined in ANSI C78.377-2017

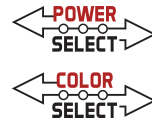

KT-CBLE45PS-24B-8CSA-VDIM

LED CENTER BASKET FIXTURE

PHOTOMETRIC SPECIFICATIONS

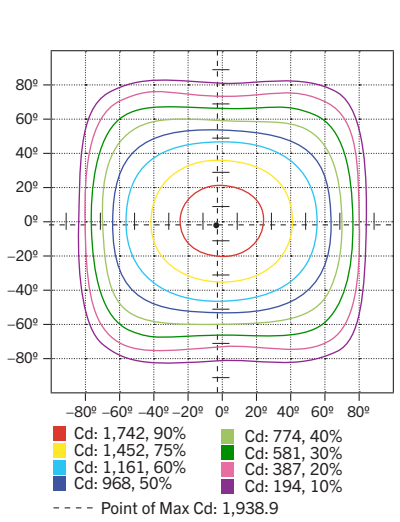

POLAR CANDELA

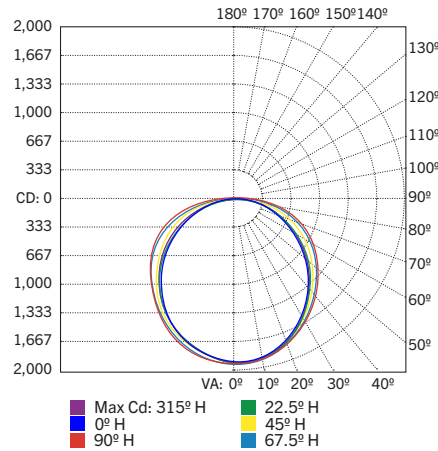

ZONAL LUMEN SUMMARY

Zone	Lumens	% Luminaire
0-60	4,384.6	74.50%
60-90	1,488.5	25.30%
0-90	5,873.1	99.70%
90-180	16.1	0.30%
0-180	5,889.1	100%

PHYSICAL SPECIFICATIONS

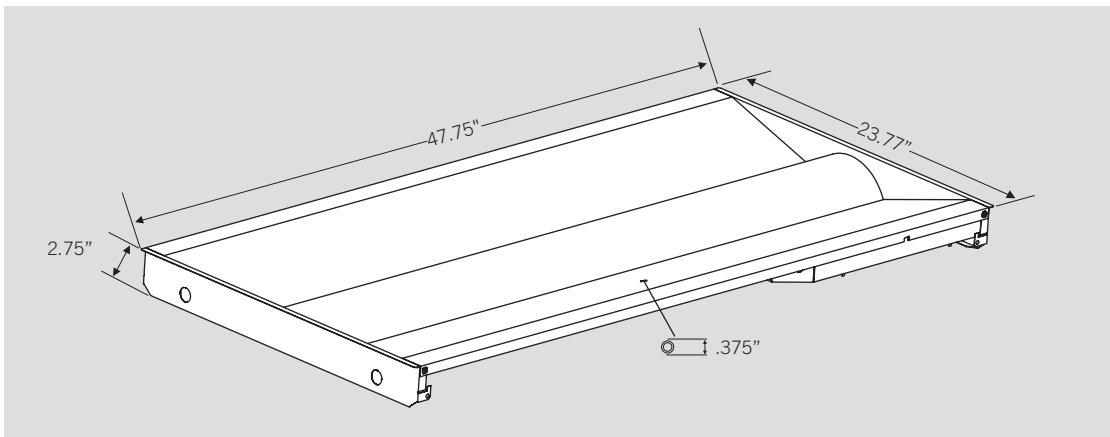

WIRING DIAGRAMS

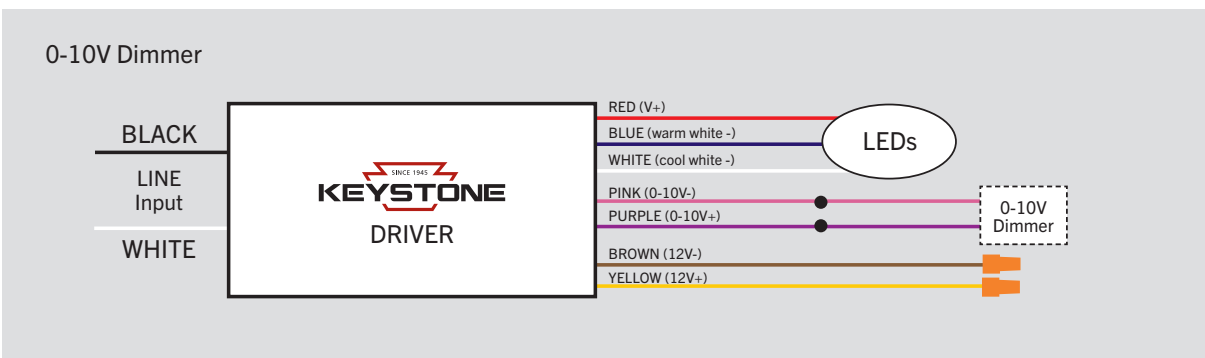

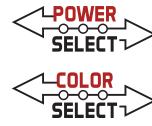

KT-CBLE45PS-24B-8CSA-VDIM

LED CENTER BASKET FIXTURE

WIRING DIAGRAMS (CONTINUED)

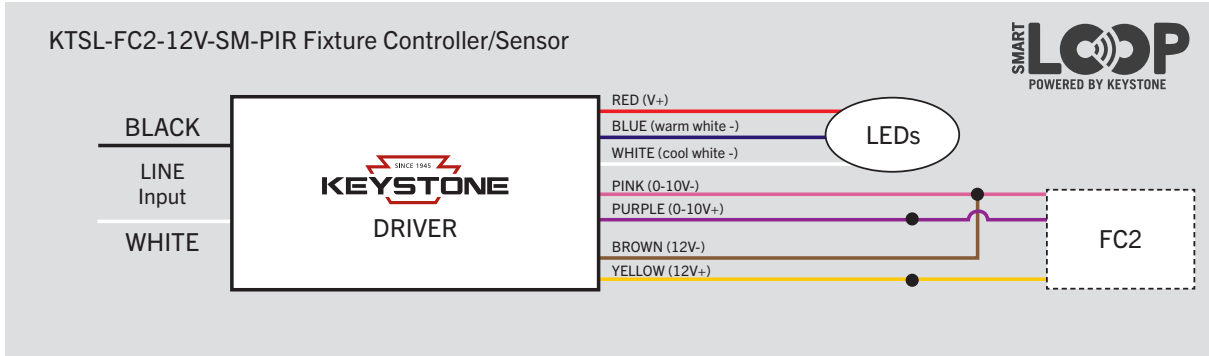

ADDITIONAL ACCESSORIES (SOLD SEPARATELY)

Catalog Number	Description
KT-EMRG-LED-5C-500	LED Emergency Back-Up, 5W Constant Wattage Design, Approx 500 lumens
KT-EMRG-LED-12C-1200	LED Emergency Back-Up, 12W Constant Wattage Design, Approx 1200 lumens.
KTSL-FC2-12V-SM-PIR	Bluetooth mesh wireless low voltage fixture controller for SmartLoop system with integrated daylight and PIR motion sensors



Fixture installed with KTSL-FC2-12V-SM-PIR

ORDERING INFORMATION

Catalog Number	Pack Quantity	Easy Code	UPC
KT-CBLE45PS-24B-8CSA-VDIM	TBD	TSB-09	843654134802

CATALOG NUMBER BREAKDOWN

KT-CBLE45PS-24B-8CSA-VDIM

1 2 3 4 5 6 7 8 9 10 11

- 1 Keystone Technologies
- 2 LED Center Basket Fixture
- 3 Wattage
- 4 Power Select
- 5 2X4' Nominal Length
- 6 Form Factor
- 7 800 Series
- 8 Color Select
- 9 Color Select Designation
- 10 0-10V Dimming
- 11 Sensor Option

9 Color Select Designation

A	3500K, 4000K, 5000K
---	---------------------

11 Sensor Options

	No Option
/FC2-PIR	SmartLoop PIR sensor included