

KT-CBLED35PS-22B-8CSA-VDIM

LED CENTER BASKET FIXTURE

DESCRIPTION

2' x 2' LED Center Basket Fixture | 120 – 277V Input | Frosted Lens | 0 –10V Dimming

APPLICATION

Used for commercial and industrial high bay lighting applications



PRODUCT FEATURES

- Features Keystone Color Select technology. Adjust CCT between 3500K, 4000K, or 5000K
- Features Keystone Power Select technology. Adjust power between 35W, 30W, and 24W
- Powered by Keystone 0 –10V dimming LED drivers with 12V Aux
- Architectural grade center basket volumetric design
- Ambient operating temperature: -20°C/-4°F to 50°C/122°F
- Compatible with Keystone SmartSafe emergency backups
- Available with optional integral occupancy sensor accessory, KTSL-FC2-12V-SM-PIR
- Low optical flicker
- THD: < 20%
- Power factor > 0.95
- IC Rated

POWER AND COLOR TEMPERATURE SELECTABILITY

- Keystone Color Select Technology: Adjustable CCT (3500K/4000K/5000K)
- Keystone Power Select Technology: Adjustable Wattage (35W/30W/24W)

PRODUCT SPECIFICATIONS

Catalog Number	Input Voltage	Wattage	CCT	Lumen Output	Efficacy	CRI	Power Factor	Lifetime
KT-CBLED35PS-22B-8CSA-VDIM	120–277V	35W	3500K	4,480	128 lm/W	> 80	> 0.90	50,000 hrs
			4000K	4,515	129 lm/W			
			5000K	4,550	130 lm/W			
		30W	3500K	3,930	131 lm/W			
			4000K	3,960	132 lm/W			
			5000K	3,990	133 lm/W			
		24W	3500K	3,216	134 lm/W			
			4000K	3,240	135 lm/W			
			5000K	3,264	136 lm/W			

ONE CATALOG NUMBER WITH 9 DIFFERENT OPTIONS

* Preset to highest lumen output (35W / 5000K)
 * Color Uniformity: CCT (Correlated Color Temperature) range as per guidelines outlined in ANSI C78.377-2017

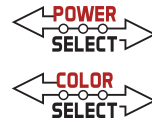

KT-CBLEDD35PS-22B-8CSA-VDIM

LED CENTER BASKET FIXTURE

PHOTOMETRIC SPECIFICATIONS

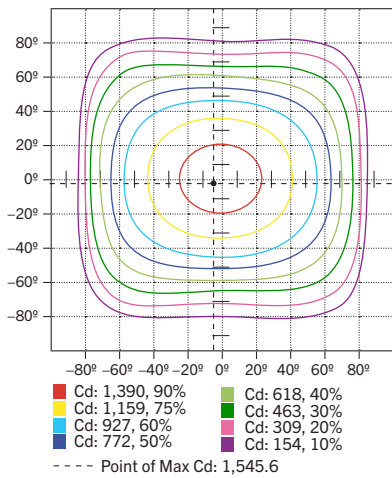

POLAR CANDELA

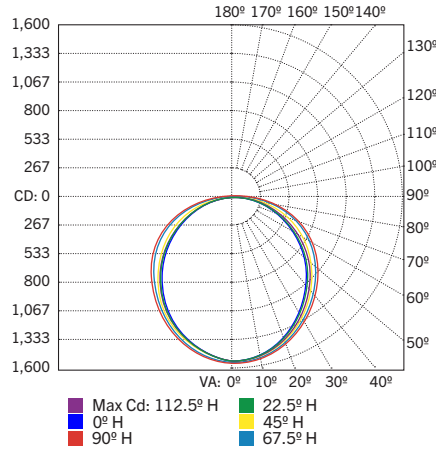

ZONAL LUMEN SUMMARY

Zone	Lumens	% Luminaire
0-60	3,486.3	74.80%
60-90	1,160.2	24.90%
0-90	4,645.5	99.70%
90-180	13.7	0.30%
0-180	4,660.2	100%

PHYSICAL SPECIFICATIONS

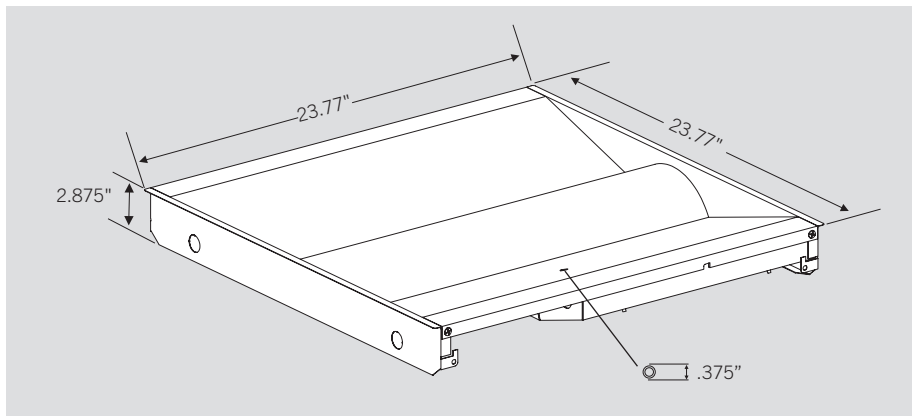

WIRING DIAGRAMS

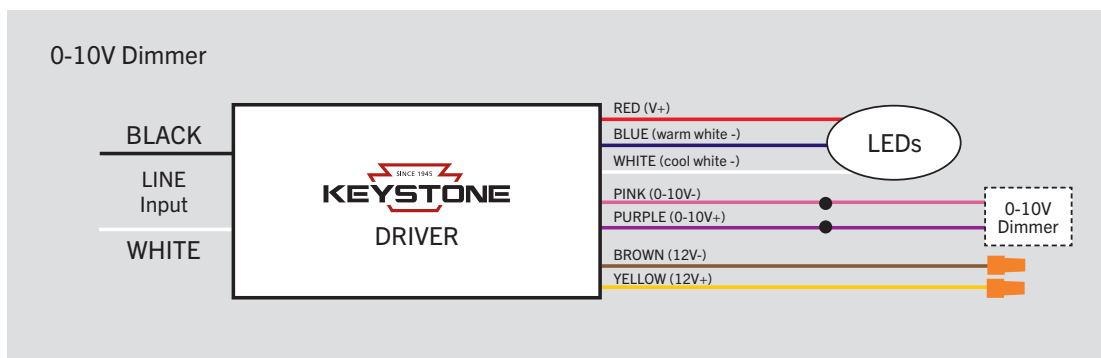

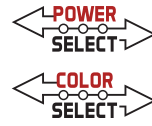

KT-CBLEDD35PS-22B-8CSA-VDIM

LED CENTER BASKET FIXTURE

WIRING DIAGRAMS (CONTINUED)

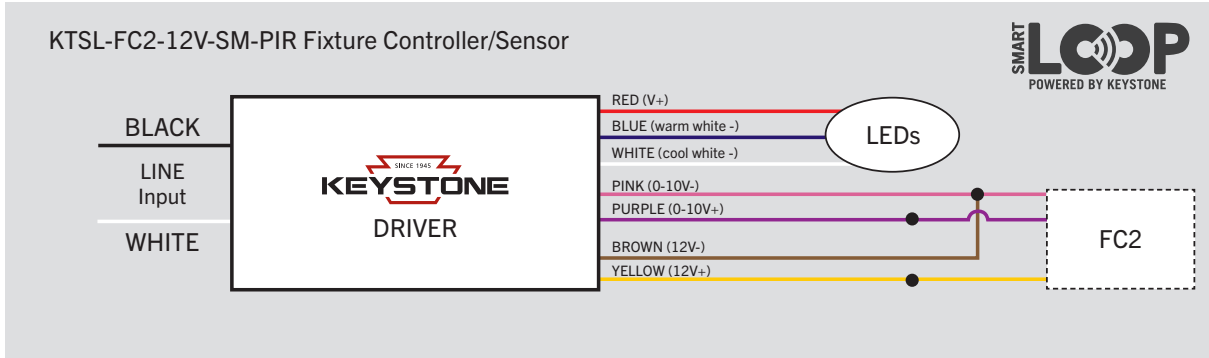

ADDITIONAL ACCESSORIES (SOLD SEPARATELY)

Catalog Number	Description
KT-EMRG-LED-5C-500	LED Emergency Back-Up, 5W Constant Wattage Design, Approx 500 lumens
KT-EMRG-LED-12C-1200	LED Emergency Back-Up, 12W Constant Wattage Design, Approx 1200 lumens.
KTSL-FC2-12V-SM-PIR	Bluetooth mesh wireless low voltage fixture controller for SmartLoop system with integrated daylight and PIR motion sensors



Fixture installed with KTSL-FC2-12V-SM-PIR

ORDERING INFORMATION

Catalog Number	Pack Quantity	Easy Code	UPC
KT-CBLEDD35PS-22B-8CSA-VDIM	TBD	SXT-05	843654134789

CATALOG NUMBER BREAKDOWN

KT-CBLEDD35PS-22B-8CSA-VDIM

1
2
3
4
5
6
7
8
9
10
11

- 1 Keystone Technologies
- 2 LED Center Basket Fixture
- 3 Wattage
- 4 Power Select
- 5 2X2' Nominal Length
- 6 Form Factor
- 7 800 Series
- 8 Color Select
- 9 Color Select Designation
- 10 0–10V Dimming
- 11 Sensor Options

9 Color Select Designation

A	3500K, 4000K, 5000K
---	---------------------

11 Sensor Options

	No Option
/FC2-PIR	SmartLoop PIR sensor included