

# KT-CBLED24PS-22B-8CSA-VDIM

## LED CENTER BASKET FIXTURE

**DESCRIPTION**

2' x 2' LED Center Basket Fixture | 120 – 277V Input |  
Frosted Lens | 0 – 10V Dimming

**APPLICATION**

Used for commercial recessed ceiling applications



**PRODUCT FEATURES**

- Features Keystone Color Select technology. Adjust CCT between 3500K, 4000K, or 5000K
- Features Keystone Power Select technology. Adjust power between 24W, 18W, and 15W
- Powered by Keystone 0 – 10V dimming LED drivers with 12V Aux
- Architectural grade center basket volumetric design
- Ambient operating temperature: -20°C/-4°F to 50°C/122°F
- Compatible with Keystone SmartSafe emergency backups
- Available with optional integral occupancy sensor accessory, KTSL-FC2-12V-SM-PIR
- Low optical flicker
- THD: < 20%
- Power factor > 0.95
- IC Rated

**POWER AND COLOR TEMPERATURE SELECTABILITY**

- Keystone Color Select Technology: Adjustable CCT (3500K/4000K/5000K)
- Keystone Power Select Technology: Adjustable Wattage (24W/18W/15W)

**PRODUCT SPECIFICATIONS**

Catalog Number	Input Voltage	Wattage	CCT	Lumen Output	Efficacy	CRI	Power Factor	Lifetime
KT-CBLED24PS-22B-8CSA-VDIM	120–277V	24W	3500K	3,072	128 lm/W	> 80	> 0.90	50,000 hrs
			4000K	3,096	129 lm/W			
			5000K	3,120	130 lm/W			
		18W	3500K	2,412	134 lm/W			
			4000K	2,430	135 lm/W			
			5000K	2,448	136 lm/W			
		15W	3500K	2,055	137 lm/W			
			4000K	2,070	138 lm/W			
			5000K	2,085	139 lm/W			

**ONE CATALOG NUMBER WITH 9 DIFFERENT OPTIONS**

\* Preset to highest lumen output (24W / 5000K)  
\* Color Uniformity: CCT (Correlated Color Temperature) range as per guidelines outlined in ANSI C78.377-2017

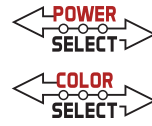

# KT-CBLEDD24PS-22B-8CSA-VDIM

## LED CENTER BASKET FIXTURE

### PHOTOMETRIC SPECIFICATIONS

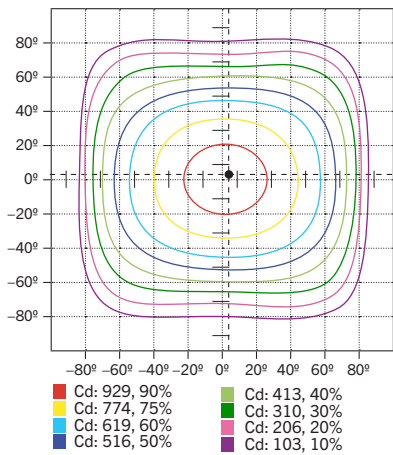

### POLAR CANDELA

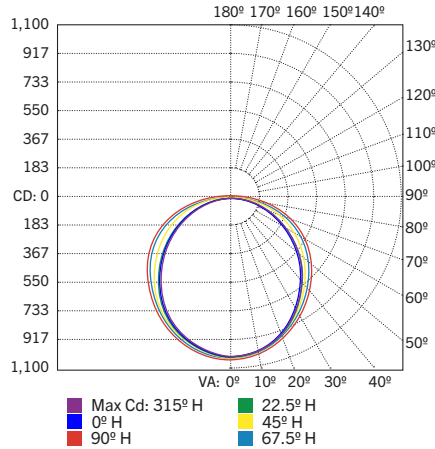

### ZONAL LUMEN SUMMARY

Zone	Lumens	% Luminaire
0-60	2,327.3	75%
60-90	768.5	24.80%
0-90	3,095.8	99.70%
90-180	9.0	0.30%
0-180	3,104.8	100%

### PHYSICAL SPECIFICATIONS

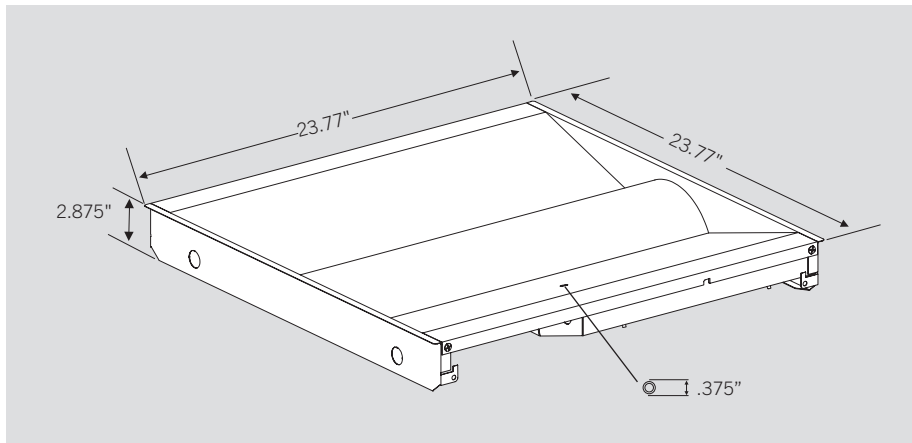

### WIRING DIAGRAMS

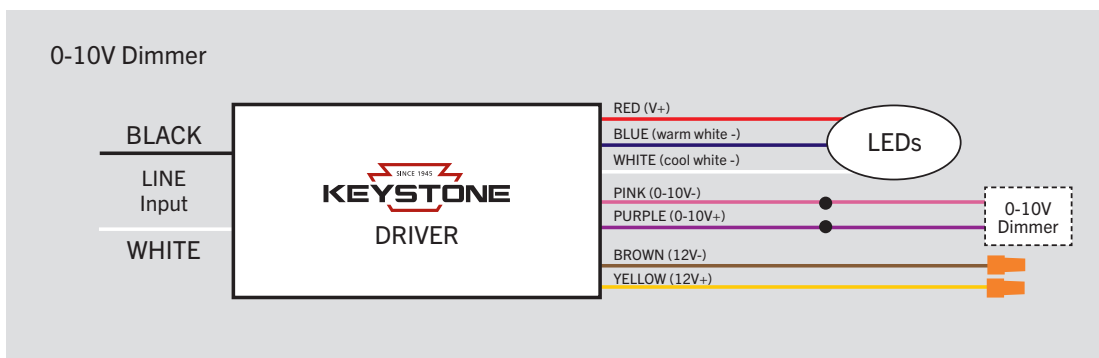

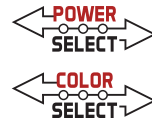

# KT-CBLED24PS-22B-8CSA-VDIM

## LED CENTER BASKET FIXTURE

### WIRING DIAGRAMS (CONTINUED)

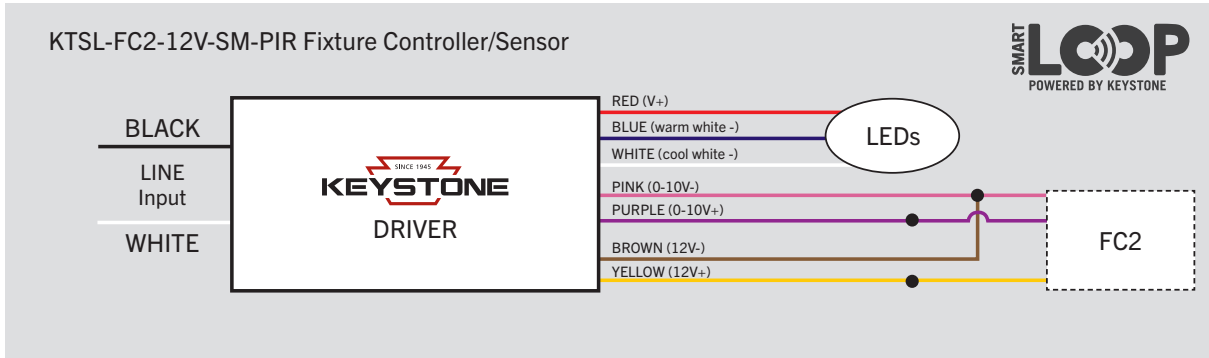

### ADDITIONAL ACCESSORIES (SOLD SEPARATELY)

Catalog Number	Description
KT-EMRG-LED-5C-500	LED Emergency Back-Up, 5W Constant Wattage Design, Approx 500 lumens
KT-EMRG-LED-12C-1200	LED Emergency Back-Up, 12W Constant Wattage Design, Approx 1200 lumens.
KTSL-FC2-12V-SM-PIR	Bluetooth mesh wireless low voltage fixture controller for SmartLoop system with integrated daylight and PIR motion sensors



Fixture installed with KTSL-FC2-12V-SM-PIR

### ORDERING INFORMATION

Catalog Number	Pack Quantity	Easy Code	UPC
KT-CBLED24PS-22B-8CSA-VDIM	TBD	CGO-95	843654134772

### CATALOG NUMBER BREAKDOWN

# KT-CBLED24PS-22B-8CSA-VDIM

1 2 3 4 5 6 7 8 9 10 11

- 1 Keystone Technologies
- 2 LED Center Basket Fixture
- 3 Wattage
- 4 Power Select
- 5 2X2' Nominal Length
- 6 Form Factor
- 7 800 Series
- 8 Color Select
- 9 Color Select Designation
- 10 0–10V Dimming
- 11 Sensor Options

#### 9 Color Select Designation

A	3500K, 4000K, 5000K
---	---------------------

#### 11 Sensor Options

	No Option
/FC2-PIR	SmartLoop PIR sensor included