



## LED LUMINAIRES



### ProLED® Select Flood Series Field Selectable Color Temperature



The new ProLED Select Flood Series offers the best value in the Commercial & Industrial Floodlight market. The FLFS Flood Series combines performance, design, and the option to select between three color temperatures in one competitively priced fixture. The FLFS Series product is made of high quality, die-cast aluminum with a poly-carbonate lens and an integrated heat sink. Combine that with a watertight, IP65 rating and you have a extremely durable fixture with a L70 of over 100,000 hours. With multiple lumen packages and mounting options, the ProLED Select Flood Series is the right fit for almost any outdoor lighting application.



**Selectable Color  
Temperature**

**7H x 6V NEMA Beam Spread**

**Die-Casting  
Aluminum Housing**

**Integrated Heat Sink**

**Polycarbonate Lens**

**IP65 Rated for Wet Locations**

#### **Applications:**

Site Lighting  
Pole Lighting  
Building Façade  
Industrial Sites  
Commercial



Contact Your Customer Care Specialist  
For Pricing, Orders And Technical Support.

800.677.3334 [www.halcolighting.com](http://www.halcolighting.com)

# ProLED® Select Flood Series

## Field Selectable Color Temperature

Product #: \_\_\_\_\_ Type: \_\_\_\_\_

Project: \_\_\_\_\_ Date: \_\_\_\_\_

Comments: \_\_\_\_\_ Initials: \_\_\_\_\_

### Performance

- Multiple Lumen Packages Ranging from 1,400 lumens to 19,000 lumens
- Overall Efficacy > 120 lm/W
- 3000K, 4000K, and 5000K in 1 Product
- 0-10V Dimming Standard
- Universal 120-277VAC
- L70 Lumen Maintenance > 100,000 hours at 25C
- CRI >70

### Construction

- Field Selectable CCT via Gasketed Switch on the Backside of the Product
- Die-Cast Aluminum Housing
- Poly-Carbonate, Shatter Resistant Lens

### Design

- Slim, Low Profile Design
- Polyester powder coat finish provides corrosion resistance
- One of the Below Mounting Options Included
  - ½" Threaded Knuckle
  - Arch Yoke
  - Slipfitter

### Certification

- UL Listed
- ROHs Compliant
- IP65, Wet Location
- DLC Premium

### Ordering Information

Product Code	Product Number	Product Description	Wattage	Equivalent Wattage
FLFS12/3CCTU/KN	10339	PROLED SELECT FLOOD; 12W, FIELD SELECTABLE CCT: 3000K, 4000K, 5000K; 120-277V, 1/2 IN THREADED KNUCKLE MOUNT	12W	50W
FLFS12/3CCTU/YK	10340	PROLED SELECT FLOOD; 12W, FIELD SELECTABLE CCT: 3000K, 4000K, 5000K; 120-277V, YOKE MOUNT	12W	50W
FLFS30/3CCTU/KN	10341	PROLED SELECT FLOOD; 30W, FIELD SELECTABLE CCT: 3000K, 4000K, 5000K; 120-277V, 1/2 IN THREADED KNUCKLE MOUNT	30W	100W
FLFS30/3CCTU/YK	10342	PROLED SELECT FLOOD; 30W, FIELD SELECTABLE CCT: 3000K, 4000K, 5000K; 120-277V, YOKE MOUNT	30W	100W
FLFS50/3CCTU/KN	10343	PROLED SELECT FLOOD; 50W, FIELD SELECTABLE CCT: 3000K, 4000K, 5000K; 120-277V, 1/2 IN THREADED KNUCKLE MOUNT	50W	150W
FLFS50/3CCTU/YK	10344	PROLED SELECT FLOOD; 50W, FIELD SELECTABLE CCT: 3000K, 4000K, 5000K; 120-277V, YOKE MOUNT	50W	150W
FLFS70/3CCTU/SF	10345	PROLED SELECT FLOOD; 70W, FIELD SELECTABLE CCT: 3000K, 4000K, 5000K; 120-277V, SLIPFITTER KNUCKLE MOUNT	70W	175W
FLFS70/3CCTU/YK	10346	PROLED SELECT FLOOD; 70W, FIELD SELECTABLE CCT: 3000K, 4000K, 5000K; 120-277V, YOKE MOUNT	70W	175W
FLFS100/3CCTU/SF	10347	PROLED SELECT FLOOD; 100W, FIELD SELECTABLE CCT: 3000K, 4000K, 5000K; 120-277V, SLIPFITTER KNUCKLE MOUNT	100W	250W
FLFS100/3CCTU/YK	10348	PROLED SELECT FLOOD; 100W, FIELD SELECTABLE CCT: 3000K, 4000K, 5000K; 120-277V, YOKE MOUNT	100W	250W
FL150/U50/SF	10349	HALCO LED FLOOD, 150W, 120-277V, 5000K, SLIPFITTER KNUCKLE MOUNT <b>**Not CCT Selectable**</b>	150W	400W
FL150/U50/YK	10350	HALCO LED FLOOD, 150W, 120-277V, 5000K, YOKE MOUNT <b>**Not CCT Selectable**</b>	150W	400W
PC/120-277	10141	BUTTON PHOTOCELL; 120-277		

# ProLED® Select Flood Series

## Field Selectable Color Temperature

Product #: \_\_\_\_\_ Type: \_\_\_\_\_

Project: \_\_\_\_\_ Date: \_\_\_\_\_

Comments: \_\_\_\_\_ Initials: \_\_\_\_\_

### Specification Table

Related Wattage	12	30	50	70	100	150
Energy Savings	50W EQUIVALENT	100W EQUIVALENT	150W EQUIVALENT	175W EQUIVALENT	250W EQUIVALENT	400W EQUIVALENT
Power Factor	<0.9					
L70 Lifetime*	>100,000 Hours					
Input Voltage	120-277VAC					
Surge Protection	4kV Standard					
Optical Distributions	7H X 6V					
Mounting Options	Mounting Included Standard: Slipfitter Knuckle or Arch Yoke					
CCT	Field Selectable 3000K, 4000K, 5000K					5000K
Warranty	5 Year					
Finish	Bronze					
Wet	IP65, UL Wet Location					
DLC	DLC Premium					
Lens	Polycarbonate					
Housing	Die Cast Aluminum					
Weight (lbs)	1.67	2.31	2.75	6.49	6.55	6.55
Master Carton Quantity	20	20	10	5	5	5

\*Useful Life is defined as the point in time at which the lamp will maintain at least 70% of its initial lumens. The lamp will continue to operate past this point at decreased light levels. May not be compatible with all dimming systems, dimming performance may vary by system.  
 Warranty – Commercial / Industrial: This product is warranted for 5 years from the date of purchase.

### Scaled Performance

Related Wattage	CRI	Scaled THD %	Scaled Power Factor	3000K		4000K		5000K	
				Scaled Lumens	Scaled Efficacy	Scaled Lumens	Scaled Efficacy	Scaled Lumens	Scaled Efficacy
12	>70	17.58	0.9	1471	123	1657	138	1538	128
30	>70	15.88	0.9	3411	114	3819	127	3597	120
50	>70	16.44	0.9	6292	126	7148	143	6645	133
70	>70	10.29	0.9	9600	137	10558	151	10252	146
100	>70	10.63	0.9	13051	131	14451	145	13837	138
150	>70	9.78	0.9	–	–	–	–	19816	132

# ProLED® Select Flood Series

## Field Selectable Color Temperature

Product #: \_\_\_\_\_ Type: \_\_\_\_\_  
 Project: \_\_\_\_\_ Date: \_\_\_\_\_  
 Comments: \_\_\_\_\_ Initials: \_\_\_\_\_

### Dimensions

#### 12W Model Dimensions

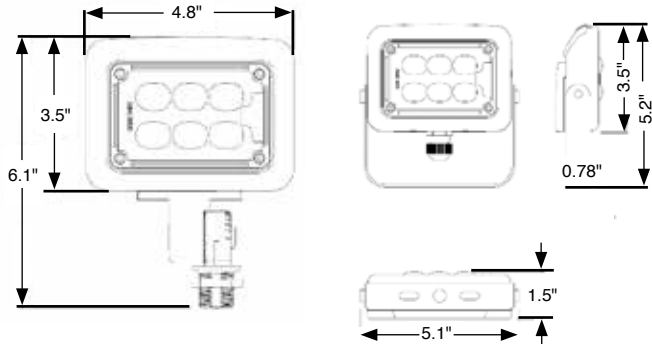

#### 30W Model Dimensions

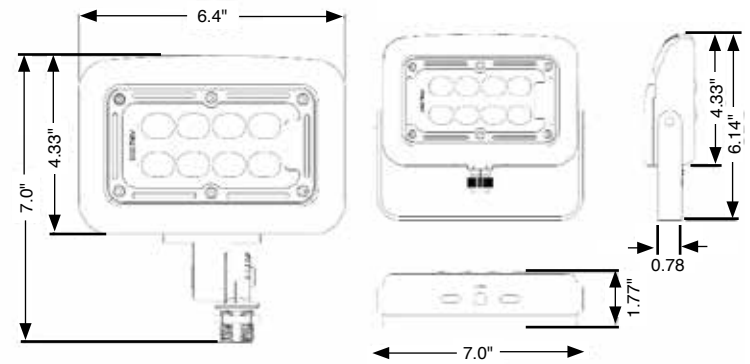

#### 50W Model Dimensions

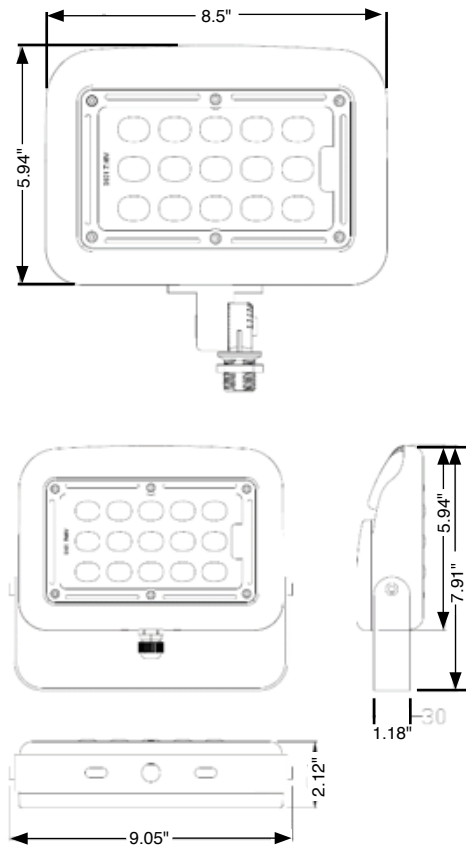

#### 70W, 100W & 150W Model Dimensions

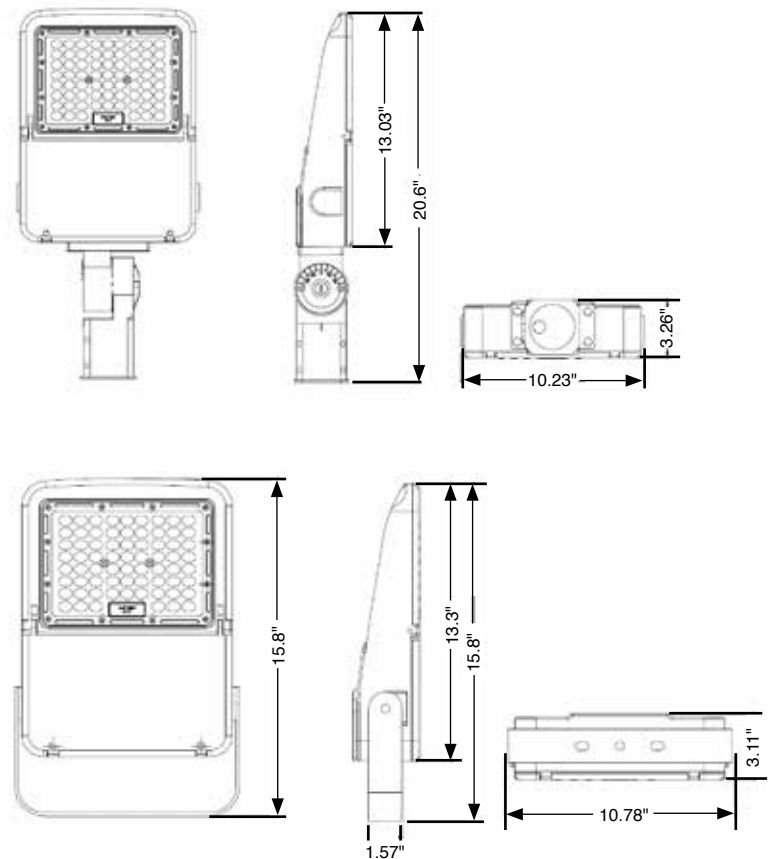

# ProLED® Select Flood Series

## Field Selectable Color Temperature

Product #: \_\_\_\_\_ Type: \_\_\_\_\_  
 Project: \_\_\_\_\_ Date: \_\_\_\_\_  
 Comments: \_\_\_\_\_ Initials: \_\_\_\_\_

### Dimensions

#### 12W

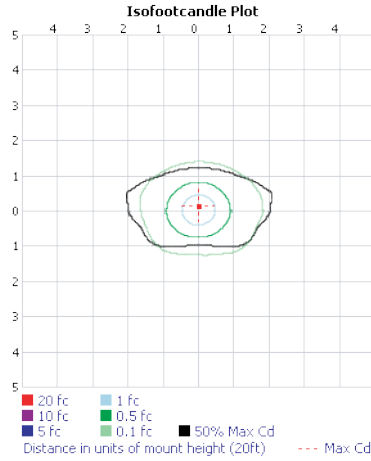
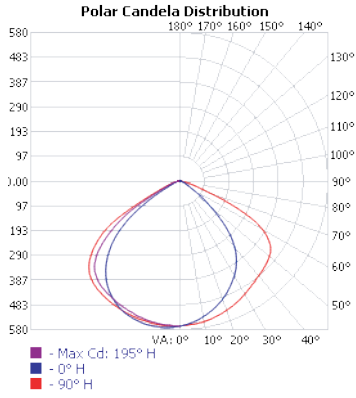

**ZONAL LUMEN SUMMARY**

ZONE	LUMENS	% LAMP	% LUMINAIRE
0-30	448.2	30.7%	30.7%
0-40	745.1	51.1%	51.1%
0-60	1,301.2	89.2%	89.2%
60-90	146.5	10%	10%
70-100	43.0	2.9%	2.9%
90-120	11.2	0.8%	0.8%
0-90	1,447.7	99.2%	99.2%
90-180	11.4	0.8%	0.8%
0-180	1,459.1	100%	100%

**LUMENS PER ZONE**

ZONE	LUMENS	% TOTAL	ZONE	LUMENS	% TOTAL
0-10	53.6	3.7%	90-100	3.6	0.2%
10-20	155.0	10.6%	100-110	3.6	0.2%
20-30	239.5	16.4%	110-120	4.1	0.3%
30-40	296.9	20.3%	120-130	0.2	0%
40-50	310.5	21.3%	130-140	0.000	0%
50-60	245.6	16.8%	140-150	0.000	0%
60-70	107.0	7.3%	150-160	0.000	0%
70-80	30.2	2.1%	160-170	0.000	0%
80-90	9.3	0.6%	170-180	0.000	0%

#### 30W

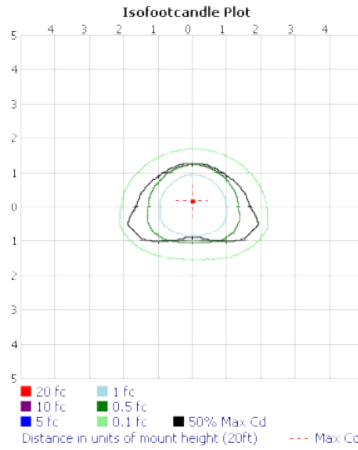
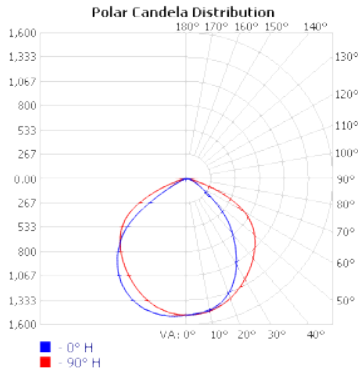

**ZONAL LUMEN SUMMARY**

ZONE	LUMENS	% LAMP	% LUMINAIRE
0-30	1,169.3	31.6%	31.6%
0-40	1,907.2	51.5%	51.5%
0-60	3,266.3	88.2%	88.2%
60-90	407.8	11%	11%
70-100	122.2	3.3%	3.3%
90-120	28.0	0.8%	0.8%
0-90	3,674.1	99.2%	99.2%
90-180	28.6	0.8%	0.8%
0-180	3,702.7	100%	100%

**LUMENS PER ZONE**

ZONE	LUMENS	% TOTAL	ZONE	LUMENS	% TOTAL
0-10	142.1	3.8%	90-100	8.3	0.2%
10-20	409.3	11.1%	100-110	9.3	0.3%
20-30	617.9	16.7%	110-120	10.5	0.3%
30-40	737.9	19.9%	120-130	0.5	0%
40-50	750.8	20.3%	130-140	0.000	0%
50-60	608.3	16.4%	140-150	0.000	0%
60-70	293.9	7.9%	150-160	0.000	0%
70-80	90.9	2.5%	160-170	0.000	0%
80-90	23.0	0.6%	170-180	0.000	0%

#### 50W

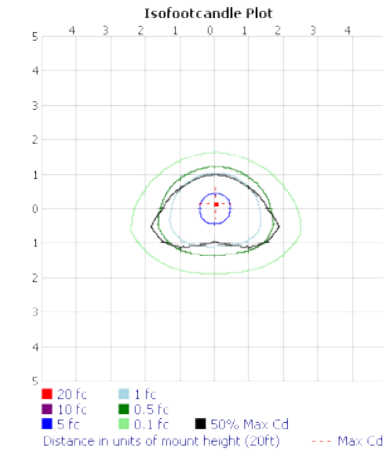
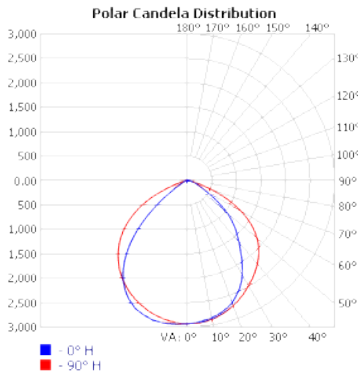

**ZONAL LUMEN SUMMARY**

ZONE	LUMENS	% LAMP	% LUMINAIRE
0-30	2,282.2	33.1%	33.1%
0-40	3,707.6	53.7%	53.7%
0-60	6,125.8	88.7%	88.7%
60-90	724.3	10.5%	10.5%
70-100	244.4	3.5%	3.5%
90-120	52.2	0.8%	0.8%
0-90	6,850.1	99.2%	99.2%
90-180	53.2	0.8%	0.8%
0-180	6,903.3	100%	100%

**LUMENS PER ZONE**

ZONE	LUMENS	% TOTAL	ZONE	LUMENS	% TOTAL
0-10	277.4	4.0%	90-100	15.3	0.2%
10-20	797.9	11.6%	100-110	17.3	0.3%
20-30	1,206.9	17.5%	110-120	19.6	0.3%
30-40	1,425.4	20.6%	120-130	1.0	0%
40-50	1,389.3	20.1%	130-140	0.000	0%
50-60	1,028.9	14.9%	140-150	0.000	0%
60-70	495.2	7.2%	150-160	0.000	0%
70-80	177.5	2.6%	160-170	0.000	0%
80-90	51.5	0.7%	170-180	0.000	0%

# ProLED® Select Flood Series

## Field Selectable Color Temperature

Product #: \_\_\_\_\_ Type: \_\_\_\_\_

Project: \_\_\_\_\_ Date: \_\_\_\_\_

Comments: \_\_\_\_\_ Initials: \_\_\_\_\_

### Dimensions

#### 70W

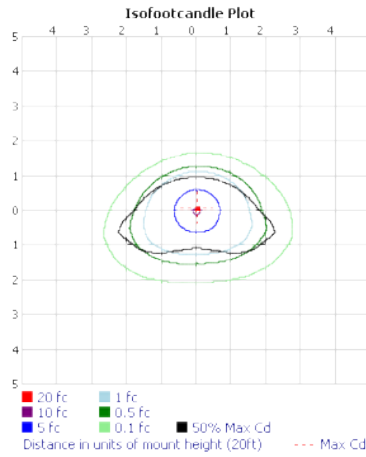
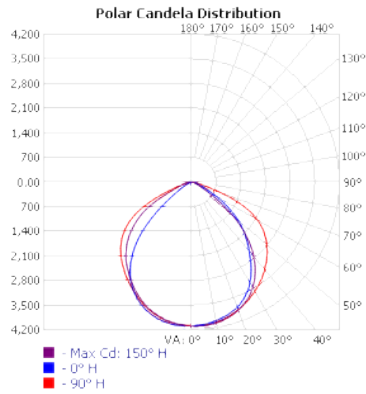

ZONAL LUMEN SUMMARY			
ZONE	LUMENS	% LAMP	% LUMINAIRE
0-30	3,181.0	32.1%	32.1%
0-40	5,180.2	52.3%	52.3%
0-60	8,741.9	88.2%	88.2%
60-90	1,164.9	11.8%	11.8%
0-90	9,906.7	100%	100%

LUMENS PER ZONE		
ZONE	LUMENS	% TOTAL
0-10	386.9	3.9%
10-20	1,111.7	11.2%
20-30	1,682.3	17.0%
30-40	1,999.2	20.2%
40-50	1,991.7	20.1%
50-60	1,570.0	15.8%
60-70	833.0	8.4%
70-80	254.7	2.6%
80-90	77.1	0.8%

#### 100W

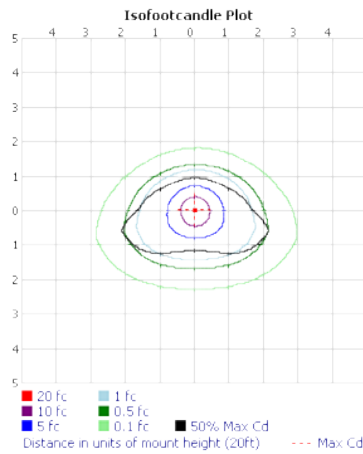
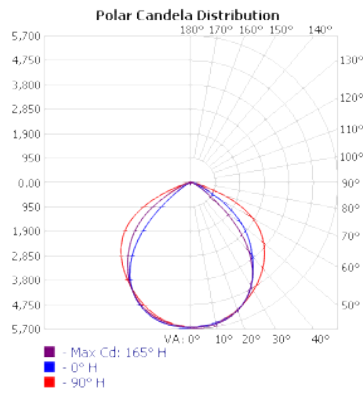

ZONAL LUMEN SUMMARY			
ZONE	LUMENS	% LAMP	% LUMINAIRE
0-30	4,373.8	31.6%	31.6%
0-40	7,132.0	51.6%	51.6%
0-60	12,046.8	87.2%	87.2%
60-90	1,665.4	12%	12.1%
70-100	534.5	3.9%	3.9%
90-120	105.9	0.8%	0.8%
0-90	13,712.1	99.2%	99.2%
90-180	107.9	0.8%	0.8%
0-180	13,820.1	100%	100%

LUMENS PER ZONE					
ZONE	LUMENS	% TOTAL	ZONE	LUMENS	% TOTAL
0-10	531.9	3.8%	90-100	31.6	0.2%
10-20	1,527.9	11.1%	100-110	35.1	0.3%
20-30	2,314.1	16.7%	110-120	39.2	0.3%
30-40	2,758.1	20.0%	120-130	2.0	0%
40-50	2,746.7	19.9%	130-140	0.000	0%
50-60	2,168.1	15.7%	140-150	0.000	0%
60-70	1,162.5	8.4%	150-160	0.000	0%
70-80	388.5	2.8%	160-170	0.000	0%
80-90	114.3	0.8%	170-180	0.000	0%

#### 150W

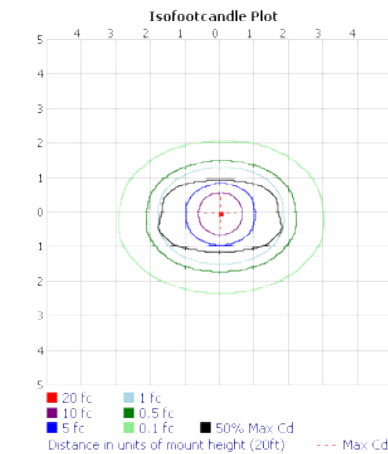
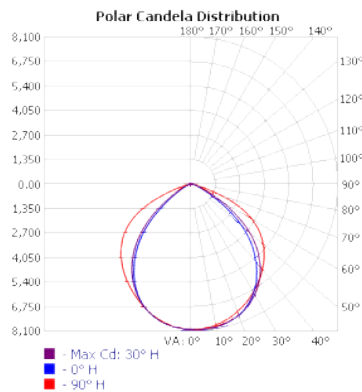

ZONAL LUMEN SUMMARY			
ZONE	LUMENS	% LAMP	% LUMINAIRE
0-30	6,221.6	31.9%	31.9%
0-40	10,139.9	52%	52%
0-60	17,106.3	87.7%	87.7%
60-90	2,240.3	11.5%	11.5%
70-100	710.1	3.6%	3.6%
90-120	148.5	0.8%	0.8%
0-90	19,346.6	99.2%	99.2%
90-180	151.4	0.8%	0.8%
0-180	19,498.0	100%	100%

LUMENS PER ZONE					
ZONE	LUMENS	% TOTAL	ZONE	LUMENS	% TOTAL
0-10	758.2	3.9%	90-100	43.9	0.2%
10-20	2,174.9	11.2%	100-110	49.3	0.3%
20-30	3,288.5	16.9%	110-120	55.3	0.3%
30-40	3,918.2	20.1%	120-130	2.9	0%
40-50	3,908.9	20.0%	130-140	0.000	0%
50-60	3,057.6	15.7%	140-150	0.000	0%
60-70	1,574.1	8.1%	150-160	0.000	0%
70-80	518.4	2.7%	160-170	0.000	0%
80-90	147.8	0.8%	170-180	0.000	0%



