



COSMO 20W 50W

APPLICATIONS

COSMO Flood lights can be used in gardens, courtyards, tennis courts and landscapes as well as for extra lighting in parking lots. It also serves to brighten pathways in parks or on campuses, or any location where having an LED outdoor light would be helpful, while avoiding the expense of running wires to the location.

DESCRIPTION

This versatile solar flood light has a separate solar panel to collect energy from the sun. The solar panel also contains a sensor which activates the light when it is sufficiently dark. This unit comes with a remote control so that you can select your desired mode, brightness and timer options. After a full charge, this solar light can be activated in increments of 10% brightness for a full 12 hours. If not fully charged, it has a built-in feature that adjusts to the maximum possible brightness for up to 12 hours. It can also be set on a timer mode for 3 hours, or 5 hours. There is also a Manual mode that allows the user to turn on the light and keep it on, for as long as desired. In this mode, the light will not turn off automatically during daylight hours and must be turned off manually.

ORDERING INFORMATION

SERIES	WATTAGE	COLOR TEMPERATURE	MOUNTING OPTIONS	FINISH
STL-SWL=COSMO	20=20W 50=50W	4=4,000K 5=5,000K	WM=WALL MOUNT	BK=BLACK

- - - -

SPECIFICATION FEATURES



Generates More Solar Energy and Stores More Energy

- Adjusting the solar panel angle maximizes solar collection & allows snow to slide off.
- The solar flood light has a separate solar panel to collect energy from the sun.
- (IAP) Intelligent Adaptive Program Battery Control Technology that stays lit all night, even through cloudy or rainy days.



Multifunctional & Flexible

- The light can be used separately from the solar panel for both indoor and outdoor uses
- Use outdoor as a flag pole light, sign light, billboard light, or wall pack
- Use indoor as bus stop & shelter lighting



Longer Life

- 6 operating modes for indoor and outdoor use
- Remote control included with one-button mode settings
- LED Indicators show 3 levels power storage



Highly Versatile Design

- The easiest way to bring lighting to both indoor and outdoor applications

CATALOG	PROJECT	COMMENTS

CERTIFICATION DATA





COSMO 20W 50W

CATALOG		COMMENTS
PROJECT		
PREPARED BY		
DATE		

PRODUCT SIZE

COSMO 20W

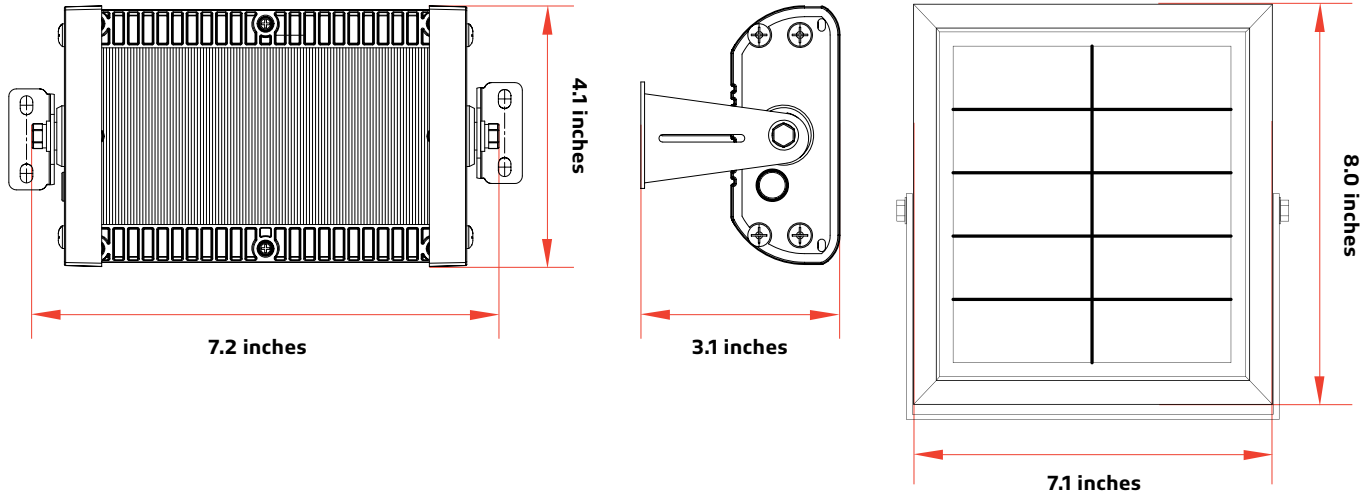

COSMO 50W

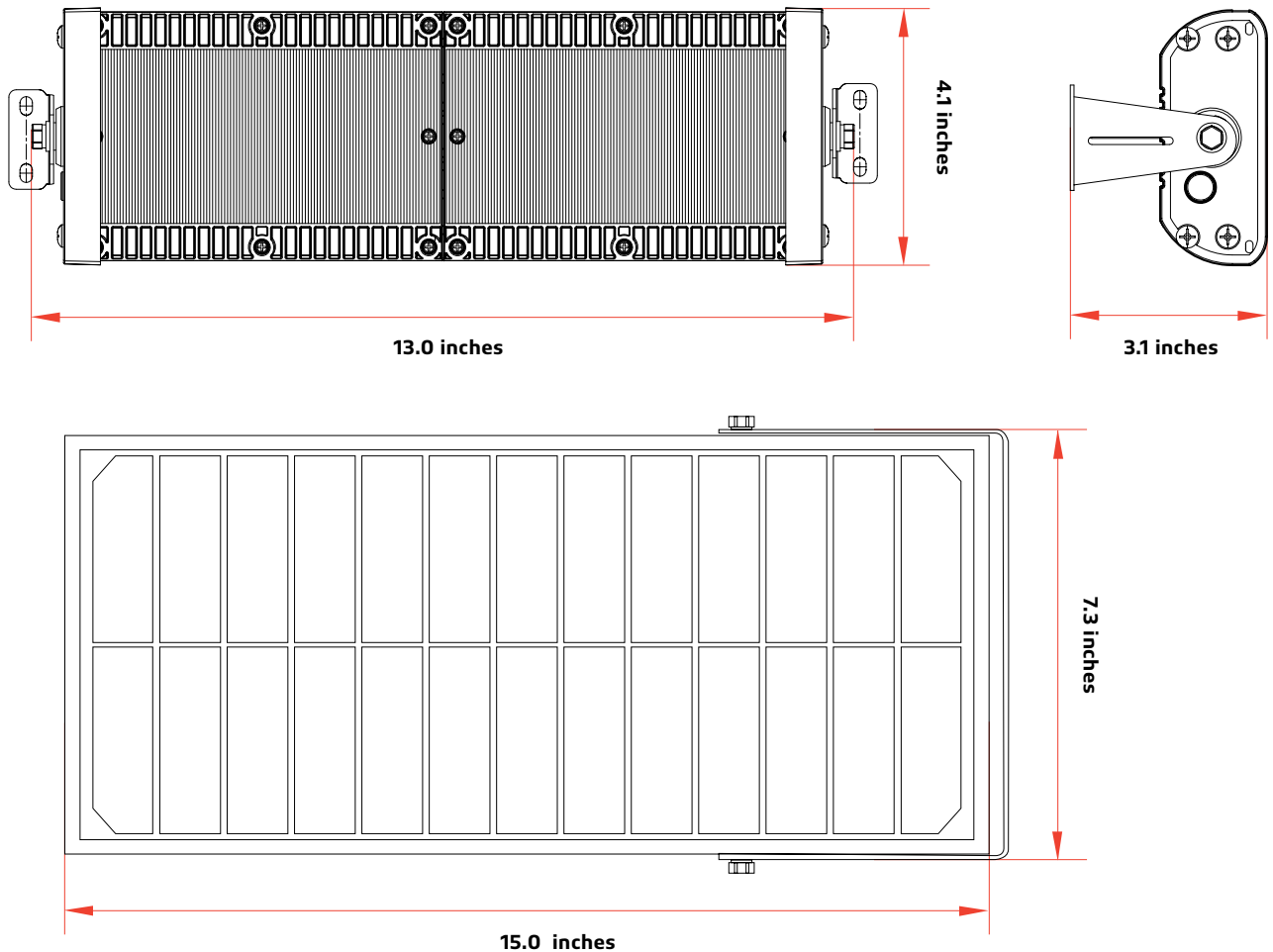

CATALOG		COMMENTS
PROJECT		
PREPARED BY		
DATE		

SPECIFICATIONS

Specifications	COSMO 20W	COSMO 50W
LED Nominal Power	20W	50W
Solar Panel	Mono-Crystalline Silicon 14V 5W	Mono-Crystalline Silicon 14V 10W
Lithium Ion Battery	28.86WH 3.7V 2.6AH	57.72WH 3.7V 2.6AH
CCT	4,000K	4,000K
Lumen Output@4,000K	3,000	6,000
CRI	> 70	> 70
Product Size	Solar Panel 8.0 X 7.1 Inches Light 7.2 X 4.1 X 3.1 Inches	Solar Panel 15.0 X 7.3 Inches Light 13.0 X 4.1 X 3.1 Inches
LED	OSRAM 3030	OSRAM 3030
EPA	0.67 ft	1.28 ft
Cable Length	13.1 ft	13.1 ft
Waterproof Rate	IP65	IP65
Casting	PC & Aluminum	PC & Aluminum
Efficiency@4,000K	150 lm/W	120 lm/W
* Charging Time	7.5 hrs (1000W/m ²)	7.5 hrs (1000W/m ²)
Run Time (@Full Power)	12-14 Hours	12-14 Hours
Operation Mode	6 Operating Modes	6 Operating Modes
* Operating Temperature	-20°C/-4°F to 140°F	-20°C/-4°F to 140°F
* Charging Temperature	-10°C/14°F to 113°F	-10°C/14°F to 113°F

* The temperature can impact the battery's charging and normal operation.

* The solar charge time data is base on 77 degree F ambient temperature with the panel pointed directly at the solar radiation. The standard radiation value is 1000W/m².

CATALOG		COMMENTS
PROJECT		
PREPARED BY		
DATE		

IES / BEAM

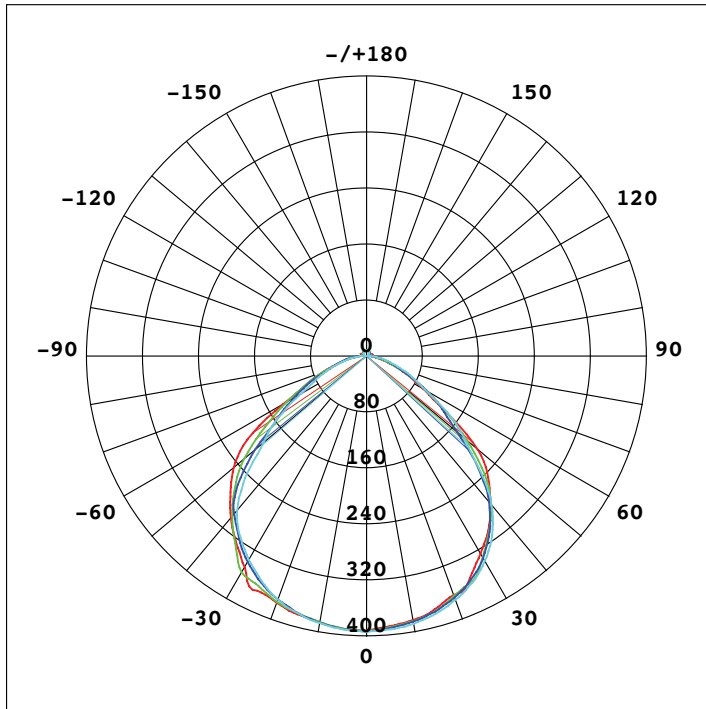

COSMO 20W

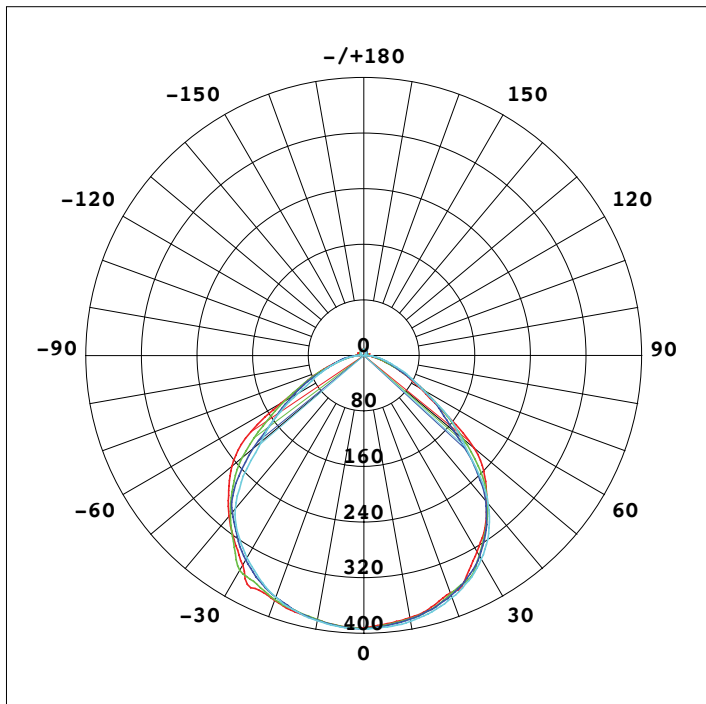

COSMO 50W

CATALOG		COMMENTS
PROJECT		
PREPARED BY		
DATE		

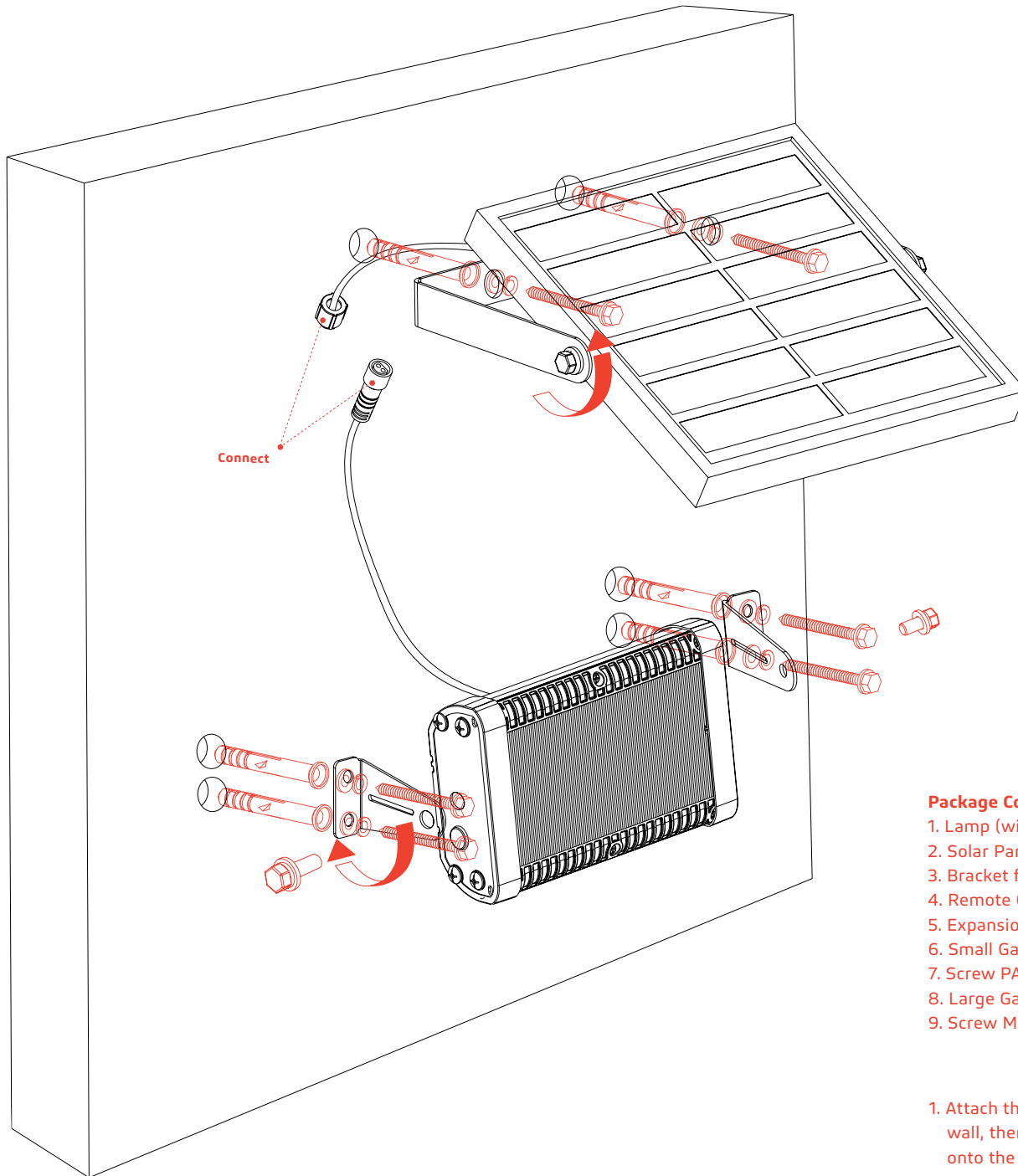





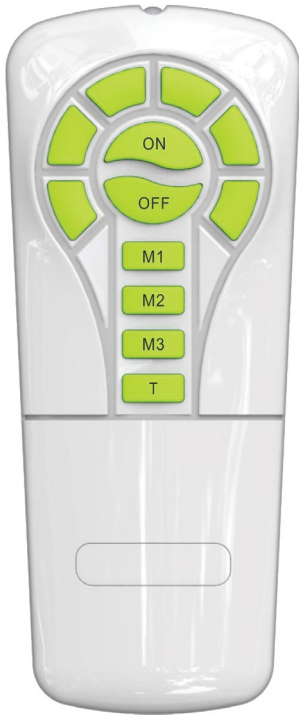

INSTALLATION

Package Contents

1. Lamp (with bracket)
2. Solar Panel
3. Bracket for Solar Panel
4. Remote Control
5. Expansion pillar-hinge (4pcs)
6. Small Gasket (4 pcs)
7. Screw PA4*25 (4 pcs)
8. Large Gasket (2 pcs)
9. Screw M5*16 (2 pcs)









1. Attach the bracket on the wall, then screw the solar panel onto the bracket.
2. Screw the bracket onto the fixture housing and mount it onto the wall.
3. Connect the light and solar panel cables.

CATALOG		COMMENTS
PROJECT		
PREPARED BY		
DATE		

REMOTE CONTROL

20W

-  **M1** 50% 5Hrs + 10% Till Dawn
-  **M2** 30% 5Hrs + 10% Till Dawn
-  **M3** 20% Till Dawn
-  **M1** +  **T** 100% 2Hrs + 50% 5Hrs + 10% Till Dawn
-  **M2** +  **T** 100% 2Hrs + 30% 5Hrs + 10% Till Dawn
-  **M3** +  **T** 100% 2Hrs + 20% Till Dawn

50W

-  **M1** 50% 5Hrs + 10% Till Dawn
-  **M2** 30% 5Hrs + 10% Till Dawn
-  **M3** 20% Till Dawn
-  **M1** +  **T** 100% 2Hrs + 50% 5Hrs + 10% Till Dawn
-  **M2** +  **T** 100% 2Hrs + 30% 5Hrs + 10% Till Dawn
-  **M3** +  **T** 100% 2Hrs + 20% Till Dawn

LIGHTING MODE INDICATOR

- Red: M1
- Green: M2
- Orange: M3
- T: Green Light Flashes

BATTERY CAPACITY INDICATOR

- Green: >70%
- Orange: 30%–70%
- Red: 10%–30%
- Note: The fixture is in low voltage protection status when the red light flashes.



CATALOG		COMMENTS
PROJECT		
PREPARED BY		
DATE		

Warning

1. Keep device away from fire and oil to avoid explosion.
2. Severe shock to Solar powered light is to be avoided.
3. Do not disassemble the light without assistance from an expert.



COSMO 20W 50W

CATALOG		COMMENTS
PROJECT		
PREPARED BY		
DATE		

WARRANTY

COSMO products are covered by a 3 year limited warranty. SOLTECH urban light warrants to the original purchaser that this product is free from defects in materials and workmanship for the period of 3 years from date of purchase. To obtain warranty service please contact your local distributor or sales rep for further instruction.



1460 Park Avenue.
Emeryville, CA 94608 USA

www.soltechlighting.com

SOLTECH LLC reserves the right to update all product data sheets at any time. Consult SOLTECH marketing specialists for publication updates at hello@soltechlighting.com

*Copyright©2022-2023 SOLTECH LLC,
All Rights Reserved.*