



Standard Finishes:



Customer Name: \_\_\_\_\_

Project Name: \_\_\_\_\_

Note: \_\_\_\_\_

Type: \_\_\_\_\_

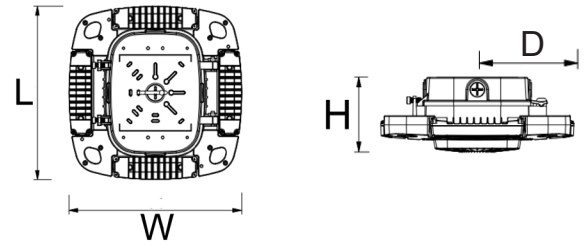

10.60"(L) X 10.60" (W) X 4.50" (H) X 5.30"(D)

## Product Description

Ceiling light with 4 rotatable light bars, allowing for controlled lumination, and a more efficient light distribution. The Die cast aluminum factory sealed housing LED light engine for a water and dust proof IP65 rated outdoor luminaire for general site lighting, alleys, loading docks, doorway, pathway and parking areas.

## Features

- Housing: Die-cast aluminum with prismatic polycarbonate lens
- Designed for 9 to 16-foot mounting heights
- No UV or IR in the beam.
- Factory-Installed Options: Sensor, Emergency Backup battery
- CRI > 80
- 70,000 hour rated life
- 7-year warranty

## Technical Specifications

### Electrical Specification:

- Input Wattage: 35W | 55W
- Input Current: 0.28A
- Input Voltage: 120-277VAC 50/60Hz
- Power factor: >0.90
- THD: <20%
- Efficacy: 131LM/W

### Mechanical Specification:

- Die-cast aluminum with bonze & White finish
- 1/2" threaded hubs located on two sides of the housing
- prismatic polycarbonate lens
- Four 1/2" hubs: 1 top, 1 on each side, 1 rear
- Operating temperature: -4°F ~ 113°F
- Lifespan: 70000 Hrs.
- IP rating: IP65, Wet Locations

### Listing Standards:



### Lighting Specification:

- Dimming: 0~10V Dimmable
- LED type/brand: SMD2835 (0.5W)
- Total lumens: 4600LM | 7250LM
- Color temperature: 3500K, 4000K and 5000K
- Color rendering index: >80
- Adjustable side light angle: 160°

### Applications:

- Indoor Parking
- Commercial Buildings
- Gas Station
- Warehoused
- Complexes
- Apartment
- Garage



# Photometrics: CDX-35W | CDX-55W

Maximum Candela = 831.19 Located At  
Horizontal Angle = 45, Vertical Angle = 54

**LCS Summary:**  
LCS Zone Lumens %Lamp % Lum

**Classification:**

Road Classification: Type VS, Very Short,  
Semi-Cutoff (depreciated)  
Upward Waste Light Ratio: 0.04  
Luminaire Efficacy Rating (LER): 116

**Polar Candela Curves:**

Vertical Plane Through:  
1) 45 - 22.5 Horizontal  
Horizontal Cone Through:  
2) 5.4 Vertical

|              |              |              |              |
|--------------|--------------|--------------|--------------|
| FL (0-30)    | 33.0         | 8.5          | 8.5          |
| FM (30-60)   | 89.06        | 22.7         | 22.7         |
| FH (60-80)   | 59.38        | 15.1         | 15.1         |
| FVH (80-90)  | 95.6         | 2.4          | 2.4          |
| BL (0-30)    | 33.27        | 8.5          | 8.5          |
| BM (30-60)   | 87.9         | 22.4         | 22.4         |
| BH (60-80)   | 56.4         | 14.4         | 14.4         |
| BVH (80-90)  | 89.1         | 2.3          | 2.3          |
| UL (90-100)  | 58.9         | 1.5          | 1.5          |
| UH (100-180) | 91.3         | 2.3          | 2.3          |
| <b>Total</b> | <b>392.8</b> | <b>100.1</b> | <b>100.0</b> |

BUG Rating E2-U3-G1

## CDX-35W

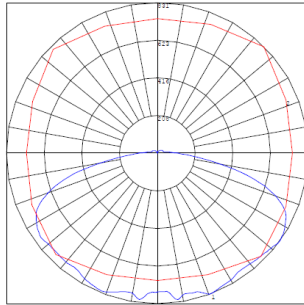
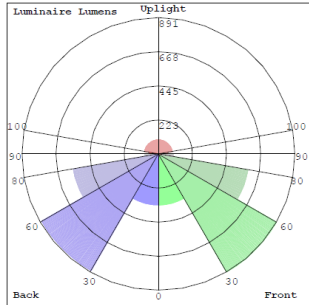
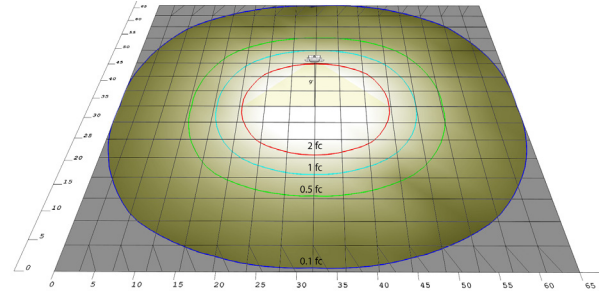

Maximum Candela = 1387.05 Located At  
Horizontal Angle = 315, Vertical Angle = 53

**LCS Summary:**  
LCS Zone Lumens %Lamp % Lum

**Classification:**

Road Classification: Type VS, Very Short,  
Semi-Cutoff (depreciated)  
Upward Waste Light Ratio: 0.04  
Luminaire Efficacy Rating (LER): 118

**Polar Candela Curves:**

Vertical Plane Through:  
1) 315 - 135 Horizontal  
Horizontal Cone Through:  
2) 5.3 Vertical

|              |               |              |              |
|--------------|---------------|--------------|--------------|
| FL (0-30)    | 552.2         | 8.7          | 8.7          |
| FM (30-60)   | 1480.6        | 23.2         | 23.2         |
| FH (60-80)   | 913.3         | 14.3         | 14.3         |
| FVH (80-90)  | 141.5         | 2.2          | 2.2          |
| BL (0-30)    | 549.7         | 8.6          | 8.6          |
| BM (30-60)   | 1458.5        | 22.9         | 22.9         |
| BH (60-80)   | 896.9         | 14.1         | 14.1         |
| BVH (80-90)  | 132.9         | 2.1          | 2.1          |
| UL (90-100)  | 94.8          | 1.5          | 1.5          |
| UH (100-180) | 158.5         | 2.5          | 2.5          |
| <b>Total</b> | <b>6378.9</b> | <b>100.1</b> | <b>100.0</b> |

BUG Rating E2-U3-G2

## CDX-55W

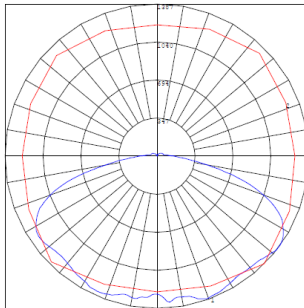
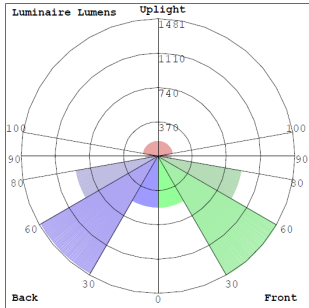
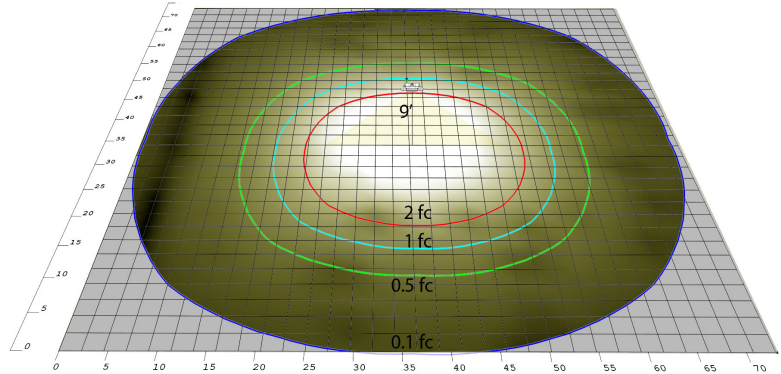

## Other Views:



Back View



Front View



Side View

## Performance Table: CDX-35W | CDX-55W

| MODEL NO.      | Wattage | Voltage  | Lumens | Color Temp | BUG Rating | LPW |
|----------------|---------|----------|--------|------------|------------|-----|
| CDX-35W-35K-BR | 35W     | 120~277V | 4600LM | 3500K      | 2-3-1      | 131 |
| CDX-35W-40K-BR | 35W     | 120~277V | 4600LM | 4000K      | 2-3-1      | 131 |
| CDX-35W-50K-BR | 35W     | 120~277V | 4600LM | 5000K      | 2-3-1      | 131 |
| CDX-35W-35K-WH | 35W     | 120~277V | 4600LM | 3500K      | 2-3-1      | 131 |
| CDX-35W-40K-WH | 35W     | 120~277V | 4600LM | 4000K      | 2-3-1      | 131 |
| CDX-35W-50K-WH | 35W     | 120~277V | 4600LM | 5000K      | 2-3-1      | 131 |
| CDX-55W-35K-BR | 55W     | 120~277V | 7250LM | 3500K      | 2-3-2      | 131 |
| CDX-55W-40K-BR | 55W     | 120~277V | 7250LM | 4000K      | 2-3-2      | 131 |
| CDX-55W-50K-BR | 55W     | 120~277V | 7250LM | 5000K      | 2-3-2      | 131 |
| CDX-55W-35K-WH | 55W     | 120~277V | 7250LM | 3500K      | 2-3-2      | 131 |
| CDX-55W-40K-WH | 55W     | 120~277V | 7250LM | 4000K      | 2-3-2      | 131 |
| CDX-55W-50K-WH | 55W     | 120~277V | 7250LM | 5000K      | 2-3-2      | 131 |



# Light Distribution Performance

Pentalux has great light distribution with 4 rotatable light bar and 1 down light. It can do two amazing things, distribute light further, useful especially in short ceiling applications. And secondly, prevent light from going to unintended areas (E.g. neighbors or sidewalks).

## Optical Distributions:

The Pentalux is designed with 4 rotatable light bars for 160 degree, allowing for controlled lumination, and a more efficient light distribution, each optimized for different application.

- **The Center Distribution (CD)** is designed for the entrance where required the higher brightness area.
- **The Wide Distribution (WD)** is designed for shining light further out, makes it possible that fewer light fixtures be installed, delivering savings on material and energy consumption.
- **The UP and Down Distribution (UD)** is designed for focusing the lumination on the ground and the ceiling with one light fixture, which becomes advantageous to prevent light from polluting the sidewalk or any other unintended areas

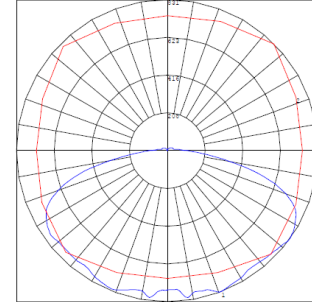

Center (WD)

## Light Distribution Comparison:

- Parking Area: 65' x 65'
- Mounting Height: 9'
- Min. Foot Candle: Highlighted in red for less than 0
- Comparison: Westgate vs. McGrawEdison vs. Cree vs. Venture

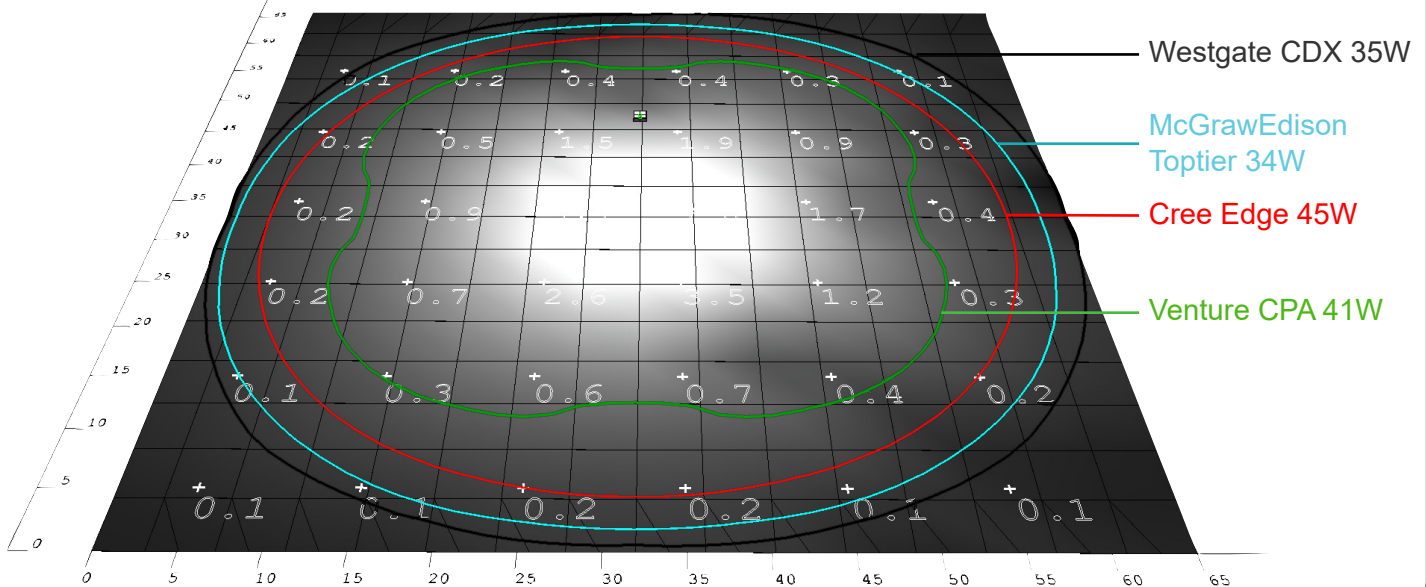
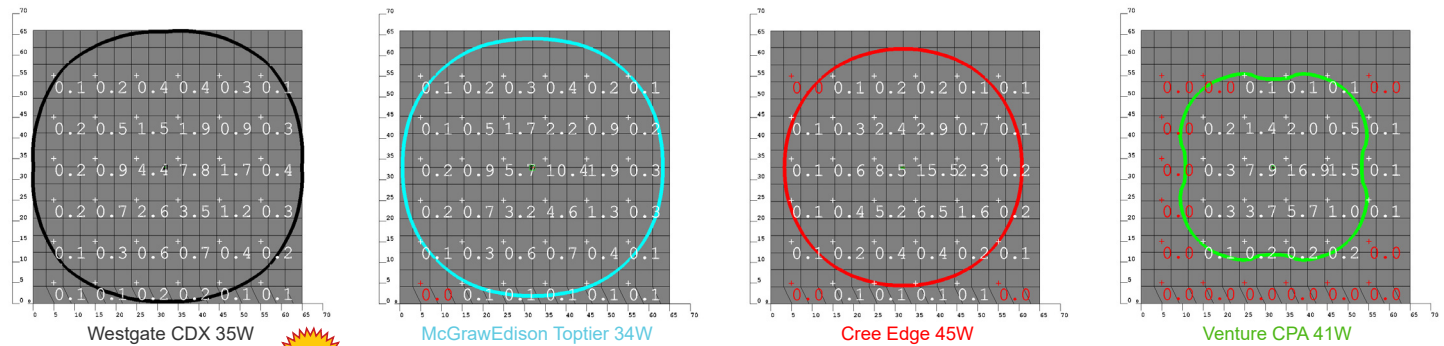

# Parking Garage Case Study

Die cast aluminum factory sealed housing LED light engine for a water and dust proof IP65 rated outdoor luminaire for general site lighting, alleys, loading docks, doorway, pathway and parking areas.

IESNA RP-20-98 Recommended Maintained Illuminance Values for Parking Garage Facilities

| Area of Illumination   | Minimum Footcandle Level (On Floor) | Maximum / Minimum Footcandle Level (On Floor) | Vertical Reading Area Of Illumination (On Floor) | Minimum Footcandle Level (60" Above Floor) <sup>1</sup> |
|------------------------|-------------------------------------|---|--|---|
| Basic                  | 1.0                                 | 10:1  | Basic  | 0.5   |
| Ramps (Day)            | 2.0                                 | 10:1  | Ramps (Day)                                      | 1.0   |
| Ramps (Night)          | 1.0                                 | 10:1  | Ramps (Night)                                    | 0.5   |
| Entrance Areas (Day)   | 50                                  | 10:1  | Entrance Areas (Day)                             | 25  |
| Entrance Areas (Night) | 1.0                                 | 10:1  | Entrance Areas (Night)                           | 0.5   |
| Stairways              | 2.0                                 | N/A   | Stairways  | 1.0   |

NOTE: <sup>1</sup> Vertical reading is taken at lowest point of horizontal illumination level.

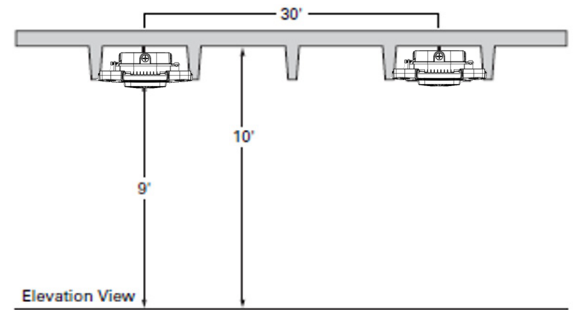

## Center of Drive Light Design Comparisons

- WestgateCDX 35W vs. Cree Edge 45W vs. Ventrue CPA 41W vs. McGrawEdison Toptier 31W
- Parking Area: 300' x 150'
- Fixture Spacing: 30'
- Mounting Height: 9'
- Avg Foot Candle: > 1 fc
- Min. Foot Candle: > 0.1 fc

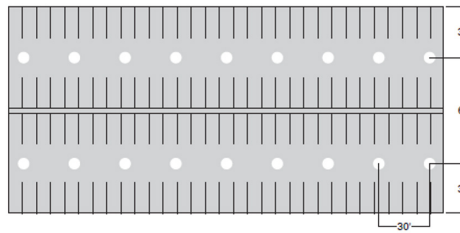

### Westgate CDX 35W x 18 pcs #1

Illuminance (Fc) Average=1.42 Minimum=0.1 Avg/Min=14.20

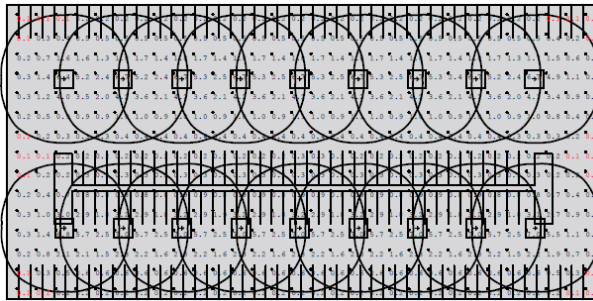

### McGrawEdison Toptier 34W x 20 pcs

Illuminance (Fc) Average=1.79 Minimum=0.1 Avg/Min=17.90

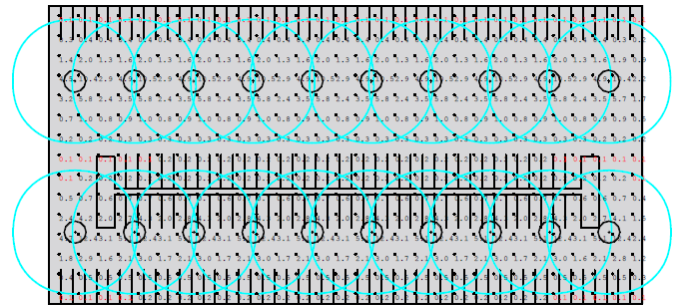

### Cree Edge 45W x 18 pcs

Illuminance (Fc) Average=2.23 Minimum=0.1 Avg/Min=22.30

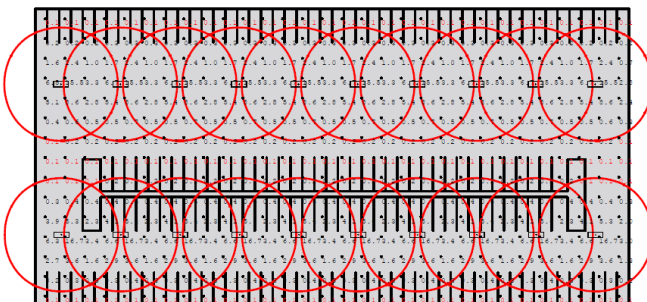

### Venture CPA 41W x 20 pcs

Illuminance (Fc) Average=1.83 Minimum=0.0 Avg/Min=N.A.

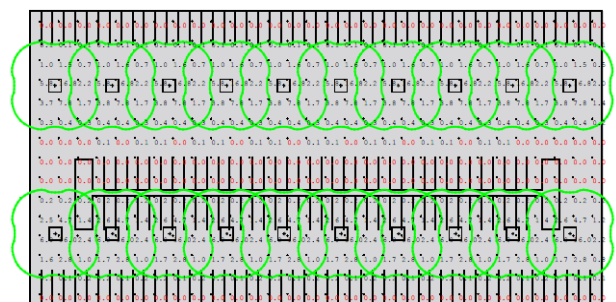

# ORDERING NUMBER

| Model | Wattage                | Color Temp                                |
|-------|------------------------|---|
| CDX   |                        |   |
|       | 35W = 35W<br>55W = 55W | 35K = 3500K<br>40K = 4000K<br>50K = 5000K |
|       |                        | BR = BRONZE<br>WH = WHITE                 |

## Accessories Options

Blank = No Option For Accessories  
**WEC-3RC = REMORTE CONTROL (WORK WITH OPT-SEN-2MDR-36)**

## Factory Installed Options

Blank = No Option For Factory-Instalaaed  
**OPT-EM-OD1INT = EMERGENCY BACKUP BATTERY**  
**OPT-SEN-2MDR-36 = PROGRAMMABLE MICROWAVE BI-LEVEL (WORK WITH WEC-3RC)**

## Example:

1. CDX-35W-35K-BR (For CDX 35W 3500K fixture 120V-277V)
2. CDX-35W-35K-BR (For CDX 35W 3500K fixture 120V-277V)  
 WML-3RC (For Remote Control)
3. CDX-35W-35K-BR (For CDX 35W 3500K fixture 120V-277V)  
 WML-3RC (For Remote Control)  
 OPT-SEN-2MDR-36 (For Factory Installed Sensor)

## SENSOR AND REMOTE CONTROL



OPT-SEN-2MDR-36



WEC-3RC

## EMERGENCY BACKUP BATTERY



OPT-EM-OD1INT



# Occupancy Sensor

EC-2MDRH-36 is a moving object sensor that can detect range of 360° and it's working frequency is 5.8GHz. The advantage of this product is stable working state (stable working temperature: -40°C-+ 70° C), WEC-2MDRH-36 adopts a microwave sensor(high-frequency output <0.2mW),so that it is safe and performs better than infrared sensor.

## Function And Options

- Daylight Harvesting Function  
 A control method based on the control of artificial light with available natural light. The purpose is to control the output of artificial light according to the change of natural light, while ensuring that the illumination of the target space does not change to maintain a certain illumination.
- ON-OFF Function  
 Switch on the lamp on detection of movement, and switch off after a hold time when there is no motion detected. As built-in daylight sensor can read brightness value, the sensor does not switch on the lamp if with sufficient natural light.

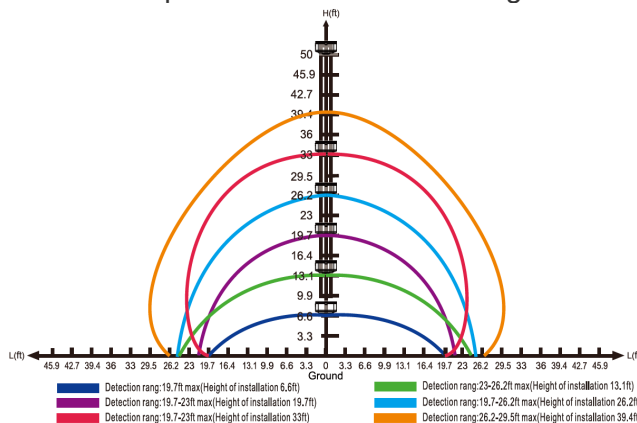

ceiling installation

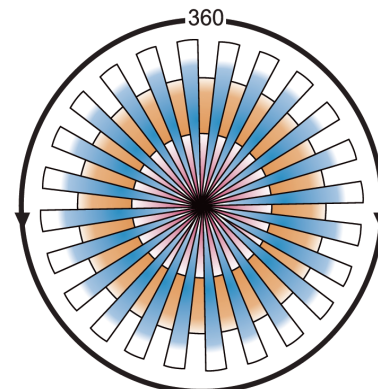

Detection angle

