

G2S

DUO FLAT PANEL GEN 2S

DUO Selectable Flat Panel

FPBL-T DUO SELECTABLE FLAT PANEL

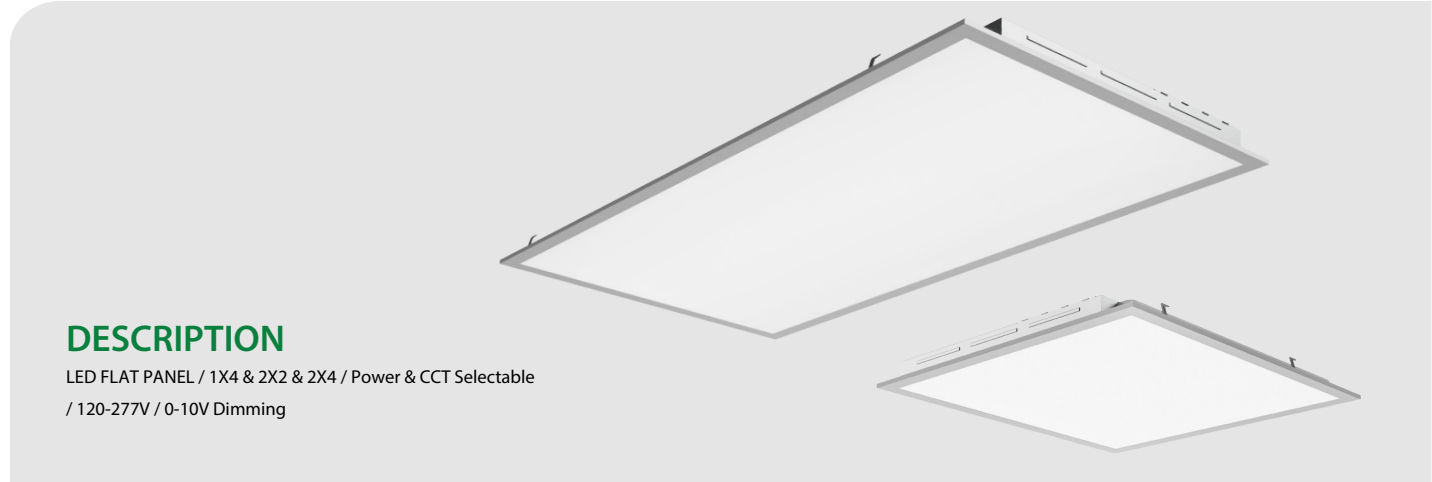

DESCRIPTION

LED FLAT PANEL / 1X4 & 2X2 & 2X4 / Power & CCT Selectable
/ 120-277V / 0-10V Dimming



PRODUCT FEATURES

- Low profile, low glare, low flicker, classic design
- PMMA lens, PS diffuser
- Ambient operating temperature: -10°C (14°F) to 40°C(104°F)
- THD<14%, Power Factor>0.97
- Emergency backup options available
- Stand Alone Fixture Control(SAFC) options available
- BLE Mesh Control(LLLC) and Circuit Level control(LALC) options available
- Surface mount kit and flange kit available

* Control and EM options are sold separately, lead time and extra cost may apply
* Surface mount kit and drywall are sold separately

POWER AND COLOR TEMPERATURE SELECTABILITY

- Feature Color Selectable Technology: Adjust CCT between 3500K / 4000K / 5000K
- Feature Power Selectable Technology: Adjust wattage between 20W / 25W / 30W(1X4), 16W / 20W / 30W(2X2), 30W / 40W / 50W(2X4)

PRODUCT SPECIFICATIONS

Model Number	Input Voltage	Performance								
		3500K			4000K			5000K		
		Wattage (W)	Efficacy (LM/W)	Output (LM)	Wattage (W)	Efficacy (LM/W)	Output (LM)	Wattage (W)	Efficacy (LM/W)	Output (LM)
FPBL14-20W-T1-S	120-277V	20.0	137.5	2,750	20.0	148.5	2,970	20.0	140.1	2,801
		25.0	131.1	3,278	25.0	142.5	3,562	25.0	133.9	3,348
		30.0	124.8	3,743	30.0	137.5	4,124	30.0	129.7	3,891
FPBL22-16W-T1-S		15.8	125.5	1,983	15.8	134.2	2,120	15.8	130.4	2,060
		21.5	124.3	2,673	20.7	133.7	2,769	21.5	129.9	2,799
		30.2	124.1	3,750	29.1	131.3	3,819	30.4	128.7	3,915
FPBL24-30W-T1-S		29.0	137.5	3,990	30.0	148.5	4,454	30.0	140.1	4,202
		39.9	131.1	5,232	38.6	142.5	5,493	40.0	133.9	5,356
		50.7	124.8	6,331	48.8	137.5	6,703	50.0	129.7	6,484

* FPBL24-30W-T1-S is DLC Listed. Other models are DLC Pending.
* Data for 2x4 model is based on in-house ies files. Other data is extrapolated.

FPBL-T DUO SELECTABLE FLAT PANEL

PHOTOMETRIC SPECIFICATIONS

FPBL22-16W-T1-S @30W 4000K

ISOCANDELA PLOT

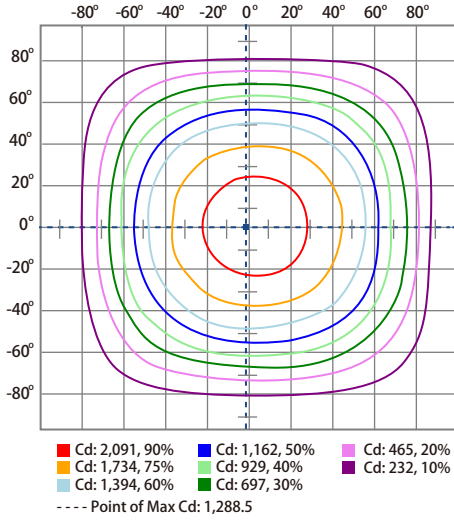

POLA CANDELA DISTRIBUTION

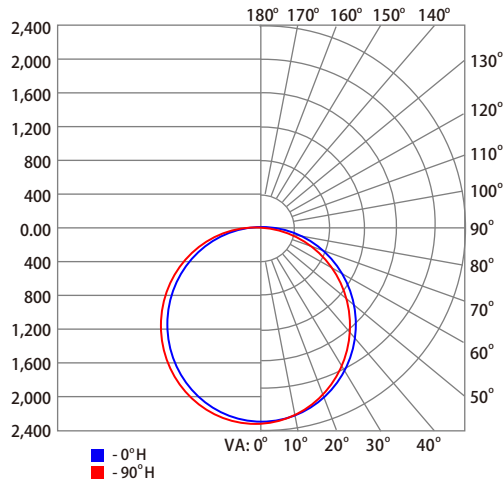

ZONAL LUMEN SUMMARY

Zone	Lumens	% Lamp	% Luminaire
0-30	1,803.1	26.9%	26.9%
0-40	2,959.8	44.2%	44.2%
0-60	5,259.5	78.5%	78.5%
60-90	1,443.7	21.5%	21.5%
0-90	6,703.2	100%	100%

PHYSICAL SPECIFICATIONS

PACKAGING

SIZE	PART NO.	LENGTH (L)	WIDTH (W)	DEPTH (D1)	DEPTH (D2)	EDGE (E)
1X4	FPBL14-T1-S	47.8"	11.8"	1.77"	1.38"	1"
2x2	FPBL22-T1-S	23.8"	23.8"	1.77"	1.38"	1"
2x4	FPBL24-T1-S	47.8"	23.8"	1.77"	1.38"	1"

Recorded in inches

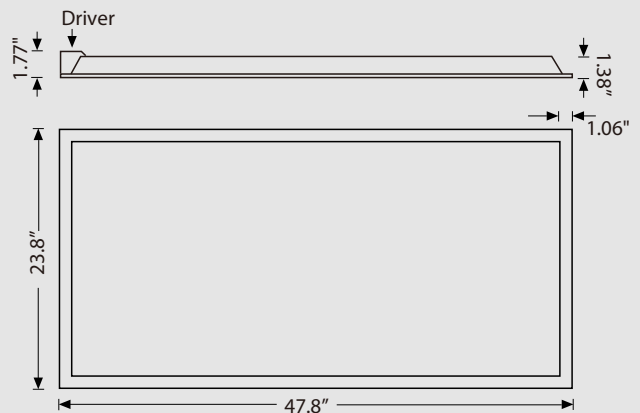
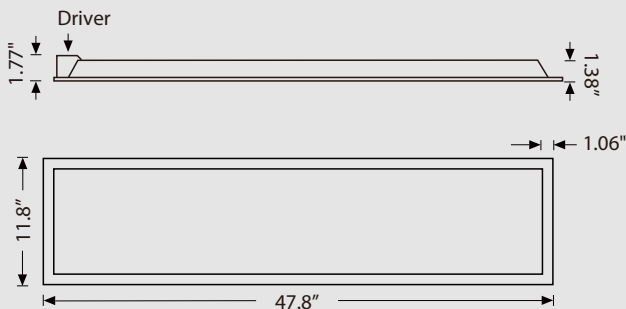
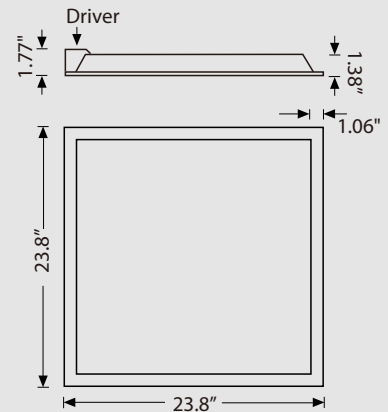

FPBL-T
DUO SELECTABLE FLAT PANEL

DUO SELECTABLE TECHNOLOGY AND PLUG-AND-PLAY SENSOR

This fixture is equipped with field-adjustable Power Select technology.

1. Ensure power is off to the fixture.
2. Open the driver compartment located on the underside of the fixture.
3. Adjust switches to desired settings.



PLUG AND PLAY MICROWAVE SENSOR

With pre-installed receptacle, microwave sensor can be added on site to save labor cost.

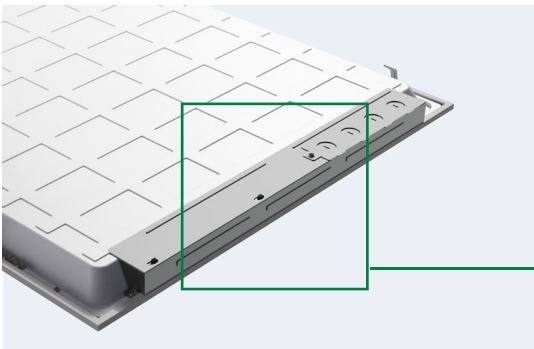

POWER & CCT SELECTABLE

Wattage and CCT can be easily adjusted via the DIP switch on the driver box.

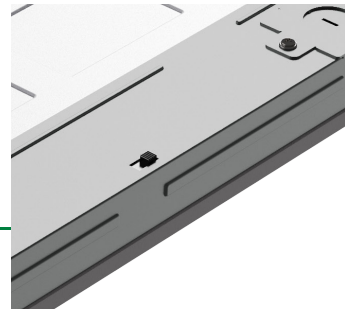

COMPATIBLE WITH BLE MESH CONTROL SYSTEM

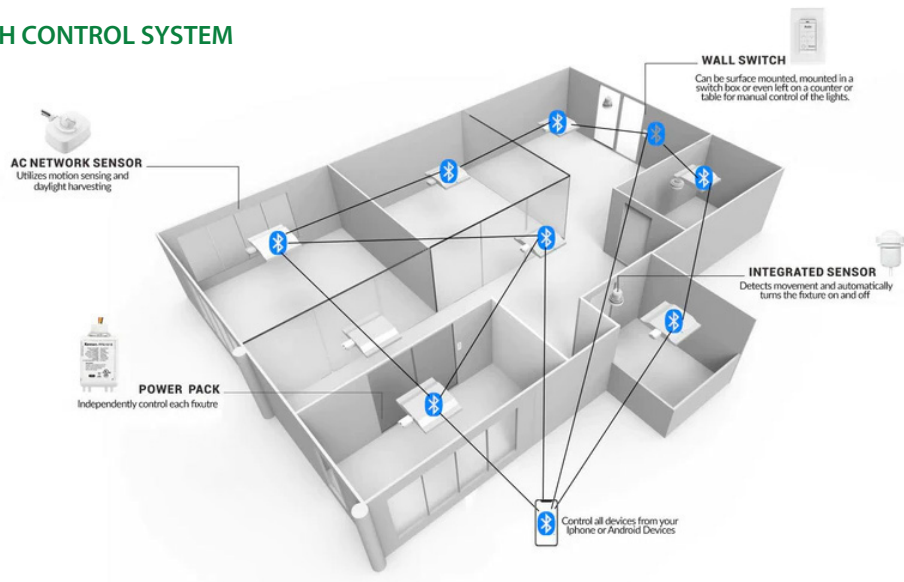

FPBL-T DUO SELECTABLE FLAT PANEL

WIRING DIAGRAMS

0-10V Dimmer



ADDITIONAL ACCESSORIES (SOLD SEPARATELY)

ATG CODE	MODEL NUMBER	DESCRIPTION
SJ	ANT-1P-4T	PIR Occupancy Sensor, 12VDC, with Daylight Harvesting Function
CJ	RC-100	Remote for ANT-1P-4T
E7	EMH-08170-FY	Emergency Backup, 120-277VAC input, Emergency Output: 8W, with Li-ion Battery
BJB	BJB-FPBL-G2	Enlarge J-box for DUO Panel G2S
SMK22	HAC-CLMB0-0600A0-RS	Surface Mount Kit for 2x2 Panel
SMK24	HAC-CLMB0-0612A0-RS	Surface Mount Kit for 2x4 Panel



ANT-1P-4T



RC-100



EMH-08170-FY



BJB-FPBL-G2

ORDER FORMAT

Series	Wattage	Function	Control&EM*	BAA
FPBL14= 1X4	20W= 20W/25W/30W Selectable	T1= DUO Selectable	RU= Receptacle for PIR Sensor, ANT-1P-4T	US= BAA Compliant
FPBL22= 2X2	16W= 16W/20W/30W Selectable	CCT Range: 3500K/4000K/5000K	RJ= Non-waterproof receptacle for IFS108	
FPBL24= 2X4	30W= 30W/40W/50W Selectable		E7= EM Unit, EMH-08170-FY	
			LLLC **	

* ANT-1P-4T is the recommended sensor for inventory, please talk to our sales team about inventory information.

** Please talk to our sales team about lead time and pricing for LLLC system.

FPBL-T DUO SELECTABLE FLAT PANEL

✓	Part Number	Description	QUICK SHIPPING*
	FPBL14-20W-T1-S	G2s DUO LED Back Lit Panel, 2x2, CCT& Power Switchable, 3500K/4000K/5000K, 20W/25W/30W, 100-277VAC, with Slim J-Box	
	FPBL22-16W-T1-S	G2s DUO LED Back Lit Panel, 2x2, CCT& Power Switchable, 3500K/4000K/5000K, 16W/20W/30W, 100-277VAC, with Slim J-Box	✓
	FPBL24-30W-T1-S	G2s DUO LED Back Lit Panel, 2x4, CCT& Power Switchable, 3500K/4000K/5000K, 30W/40W/50W, 100-277VAC, with Slim J-Box	✓
	FPBL14-20W-T1-RU-S	G2s DUO LED Back Lit Panel, 2x2, CCT& Power Switchable, 3500K/4000K/5000K, 20W/25W/30W, 100-277VAC,with Slim J-Box&12VDC AUX&Receptacle	✓
	FPBL22-16W-T1-RU-S	G2s DUO LED Back Lit Panel, 2x2, CCT& Power Switchable, 3500K/4000K/5000K, 16W/20W/30W, 100-277VAC,with Slim J-Box&12VDC AUX&Receptacle	✓
	FPBL24-30W-T1-RU-S	G2s DUO LED Back Lit Panel, 2x4, CCT& Power Switchable, 3500K/4000K/5000K, 30W/40W/50W, 100-277VAC,with Slim J-Box&12VDC AUX&Receptacle	✓
	ANT-1P-4T	Bi-Level PIR Sensor, 12~24VDC	✓
	RC-100	Remote for ANT-1P-4T	✓
	EMH-08170-FY	Emergency Backup	
✗	FPBL22-20W-T1-RU-	G2 DUO LED Back Lit Panel, 2x2, CCT& Power Switchable, 3500K/4000K/5000K, 20W/25W/30W, 100-277VAC, with Slim J-Box & 12VDC AUX & Receptacle	DISCONTINUED
✗	FPBL24-30W-T1-RU-	G2 DUO LED Back Lit Panel, 2x4, CCT& Power Switchable, 3500K/4000K/5000K, 30W/35W/40W, 100-277VAC, with Slim J-Box & 12VDC AUX & Receptacle	DISCONTINUED

* QUICK SHIPPING means this is a inventory product, please contact our sales for realtime stock information.

* "-RU-S" models are still on order.Please contact our sales for lead time.

FPBL-T DUO SELECTABLE FLAT PANEL



ANT-1P-4T(sensor)



ANT-1P-4T(connecting base)



RC-100

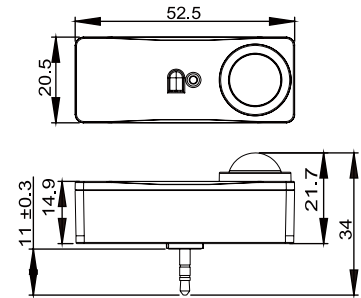

INTRODUCTION

The ANT-1P-4T is passive infrared occupancy bi-level sensor as a fixture sensor mounts in indoor light fixture and provides daylight harvest control. It works by 12-24Vdc power, and controls 0-10VDC LED drivers or dimming ballasts. All controls parameters (Hold time, task light level, stand-by level, stand-by time) are adjustable via dip switch and task light level also works by remote control.

SPECIFICATIONS

Power supply	12-24VDC, >50mA
Dim control output	0-10V, max. 25mA sinking current
Mounting height	4m Max.
Cable length	100cm
Detection angle	120°
Operating temperature	-20°C~70°C
IP rating	IP20

WARNING

NOTE: Warm up time is 40 seconds. After the sensor connects input power first time the light will keep on 40 seconds then go to dimming to work normally.

NOTE: Factory Default Setting: Task light level: 100%, Occupied timeout: 5min, Timeout light level: 20% Prolonged: 30 minutes.

NOTE: Any setting changed by remote control the led light that sensor connect will on/off as confirm.

FUNCTION AND OPTIONS

The PIR Occupancy bi-level sensor to achieve daylight harvesting control for some areas that require a light change notice before switch off.

It offers 3 levels of the light Control: Task Level (100%, 90%, 80%, 70%)-- Stand-by light level (50%, 20%)-off; and 2 periods of selectable waiting time: motion hold-time and stand-by time. Daylight harvest control works in hold-time.

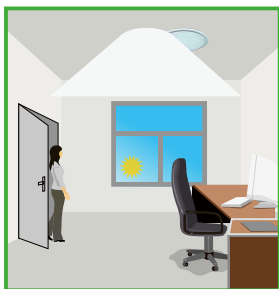

The light will always switch ON automatically on detecting presence OR manually with power switch (even without detecting presence).

When Day Light Harvesting is enabled the light output regulates between Task and Stand By levels according to the level of natural light available.

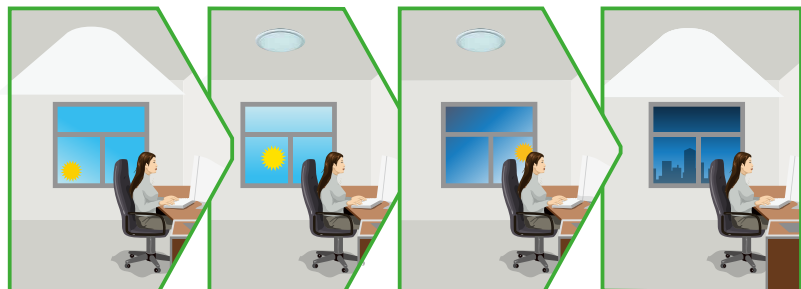

The light turns on at full or dim to maintain the lux level. The light output regulates according to the level of natural light available.

FPBL-T

DUO SELECTABLE FLAT PANEL



The light dims to "stand-by level" after hold time.



The light switches off completely after the stand-by period.

COVERAGE PATTERNS

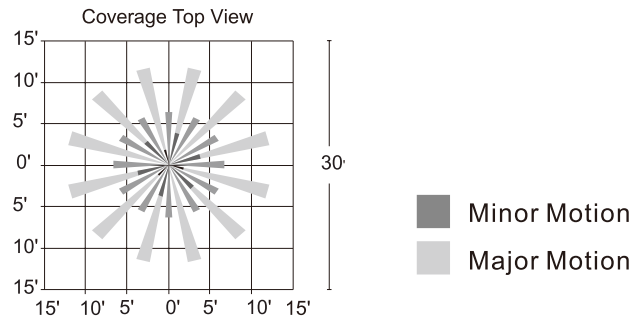
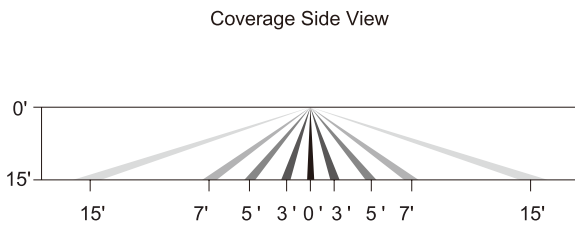

DAYLIGHT HARVESTING FUNCTION SETTING BY REMOTE CONTROL RC-100.











LED INDICATORS

LED	DESCRIPTION	LED	DESCRIPTION
BRIGHTNESS	To Set the output level (in %) of connected lighting during occupancy.		To select the current surrounding lux value as the daylight threshold. This feature enables the fixture to function well in any real application circumstances.
SENSITIVITY	To set the occupancy sensing sensitivity of the Sensor.		The built-in daylight sensor stops working, and all motion detected could turn on the lighting fixture, no matter how bright the natural light is.
HOLD TIME	The time that the Sensor will turn off (if you choose stand-by level is 0) or dim the light to a low level after the area is vacated.	STAND-BY DIM	To set the output level (in %) of connected lighting during vacancy. The sensor will regulate the lighting output at the set level. Setting the STAND BY DIM at 0 means light full off during vacancy.
DAYLIGHT SENSOR	To represents various thresholds of natural light level for the Sensor.	STAND-BY TIME	To represents the time that the Sensor will keep the light at low dim level after the HOLD TIME elapsed.

FPBL-T

DUO SELECTABLE FLAT PANEL

BUTTON OPERATION

BUTTON	DESCRIPTION	BUTTON	DESCRIPTION
	Press the "ON/OFF" button, the light goes to permanent on or permanent off mode, and the sensor is disabled. (MUST press "Auto" button to quit this mode for Setting.		Press "Auto" button, the sensor starts to function and all settings remain the same as the latest status before the light is switched on/off.
	Display the current/lastest setting parameters in LED indicators (the LED indicators will on for showing the setting parameters).		The button "TEST" is for testing purpose sensitivity only. After you choose sensitivity thresholds, then you press "TEST" button, The sensor goes to test mode (hold time is only 2s) automatically, meanwhile the stand-by period and daylight sensor are disabled. Press "AUTO" button to quit from this mode.
	Press "RESET" button, all settings go back to settings of dip Switch in sensor.		
	Enter in the setting condition, and Navigate to UP and Down for choose selected parameters in LED indicators.		Press this button for open or close the smart photocell sensor which take place of normal photocell sensor switch. When remote control enters in setting conduction, you can choose open and close the smart photocell sensor. If this smart photocell sensor open, 2 Leds indicators of daylight sensor are on for choose photocell sensor setpoint on/off to light, and Stand by time is only ☹️. When the natural light level exceeds setpoint off to light, the lights will turn off even if when the space is occupied. Once the natural light level exceeds this setpoint off to light, the sensor will wait and monitor for 1 minute in order to confirm the natural light level increase is not temporary before forcing the lights to go off. When the natural light level lower than setpoint on to light, the lights will turn on even when the space is not occupied. When natural light level goes lower than this setpoint on to light, the sensor will wait and monitor for 1 minute in order to confirm the natural light level decrease is not temporary before forcing the lights go on.
	Navigate to LEFT and RIGHT for choose selected parameters in LED indicators.		
	Keep records of selected parameters in remote control or in Mode 1 or mode 2 mode 3, mode 4.		
	Upload the selected parameters to sensors.		
	4 Scene modes with preset parameters which are available to be changed and saved in modes.		