



# Type IC 6" Slim Panel LED Recessed Lighting Fixture

Part #: GS-P6-B12(CCT)

Job Information		
Project Name		Type
Location		
Quantity		Date
Contact/Phone		

## Features

### Housing

0.4inch thickness super slim housing design, perfect for limited space installation locations. Durable die casting aluminum housing with excellent heat dissipation, provide maximum airflow for the SMD LED light source.

### LED Characteristics

This fixture contains a LM80 rated SMD LED module that offer high light color uniformity, 12 watts up to 950 lumens; Available in 3000K, 4000K, 5000K color temperature.

### Dimming

This slim panel light is dimmable from 100% down to 5% smoothly and no flicker, works with the majority of industry standard triac dimmers like Lutron/leviton, etc. Please contact us for compatible dimmer list.

### Beam Spread

The fixture lens provides 120° wide beam spread.

### Mounting

Includes two spring loaded clips to attached to any ceiling material. Easy recessed installation without needing a stand pot light can.

### LED Driver

Iron metal driver box with junction box and a reliable isolated constant current dimmable class II electronic LED driver inside.

### Quick Connect push-in terminals

Three "Quick connect" push-in terminals for fast and easy wiring.

### Operating Temperature

-20°C~40°C (-4°F~104°F)

### Environment

- Suitable for dry/damp locations.
- Approved for direct contact with insulation. (Type IC)

## Specifications

Cut-Out Size	6 inch
Wattage	12 watts
Input Voltage Range	AC120V, 60Hz
Light Source	SMD LED
Color temperature	3000K-4000K-5000K
Beam Angle	120°
Lumens Output	950±5%lm
Lumen Efficiency	80~90lm/w
Incandescent Equiv.	95 watts
Dimmable	Yes, 100%-5%
Dimming Tech	Triac dimming
Cerification	ETL,cETL,Energy Star
Power Factor	>0.95
Projected Life	70% Light Output at 50,000 Hours
Warranty	3 years
Approved Location	Insulated Ceiling & Damp Locations
IC Rated	Yes
Air Tight	Yes



## Special Features

### CCT Adjustable function

3 light color in one light.

Version A: Select a color temperature from warm white, nature white, cool white by using the DIP switch on the driver box.

Version B: Adjust the color temperature by switch on and switch off the fixture quickly within 1 seconds to change the light color circularly among warm white, nature white and cool white.



## Dimensions & Installation

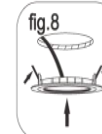
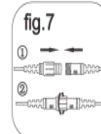
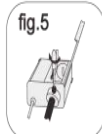
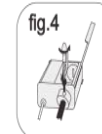
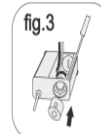
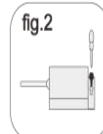
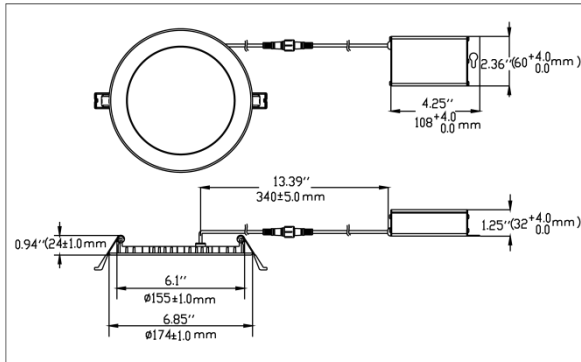

## Ordering Guide

GS-P6-B12- Color Temperature - Housing Color

DIP (DIP Switch CCT Adjustable)  
OF (On/Off CCT Change)

WH: White  
BK: Black  
BN: Brushed Nickel  
SL: Silver

