

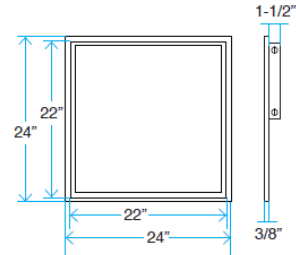

0 ~ 10v

DIMENSIONS:



24" x 24" x 1-7/8"

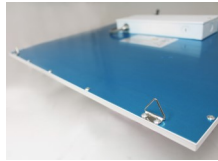

Clips located at the back of the panel

ACCESSORIES:



LP-SRFC-2X2



LP-SSPD-2X2



LP-SAFETYCLIP

LP-2X2-45W-35K-D
LP-2X2-45W-40K-D
LP-2X2-45W-50K-D

LED Panel Light (2x2)

Superb brightness that saves 75% energy compared with traditional panel lights.

ELECTRICAL SPECIFICATIONS:

- Power efficiency: >0.87
- Power factor: >0.9
- High efficiency: 85lm/w
- Input voltage: AC100V~277V
- Output voltage: 36VDC
- LED type: 4014SMD LM80
- Color rendering index: Ra > 82
- With external constant current power supply

LIGHTING SPECIFICATIONS:

- Dimmable 0 ~ 10v Dimming
- Current (mA): 1100mA
- Frequency range: 50Hz~60Hz
- Total harmonic distortion: ≤15 %
- Color temperature: 3500K, 4000K, 5000K

HOUSING SPECIFICATIONS:

- Material: AL+PMMA+PS
- Working temperature: ~ 20 ~ 45 °C
- Storage temperature: ~ 25 ~ 65 °C
- IP grade: IP20
- Working life-span: 5,000H

MODEL NO.	POWER	LUMENS	SMD4014 LEDs	CCT
LP-2X2-45W-35K-D	45W	3825	216	3500K
LP-2X2-45W-40K-D	45W	3825	216	3985K
LP-2X2-45W-50K-D	45W	3825	216	5028K

LP-SRFC-2X2	Surface mounting kit for 2x2, aluminum structure, 4pcs +screw kit
LP-SSPD-2X2	Suspending wire rope for 2x2, 3 wire pcs
LP-SAFETYCLIP	Earthquake clip for panel, 1pc

FEATURES:

- Soft and wide light emitting
- Ultra slim, unlimited design and various dimensions are available
- No infrared rays, no ultraviolet radiation, no thermal effect
- Special circuit design, avoided the single broken LED influence problem
- High efficiency constant current drive system, with heat protection system, can work under unstable voltage
- Instant start, no flickering, no humming, no RF interference

WARRANTY:

- Five-year warranty

CERTIFICATIONS:

- UL listed / LM80 rated
- DLC Standard





LP-2X2-45W-35K-D

LP-2X2-45W-40K-D

LP-2X2-45W-50K-D

LED Panel Light (2x2)



MODEL NO.	DESCRIPTION	QUANTITY	INSTALLATION
LP-SRFC-2x2	Surface mounting kit for 1x4, aluminum structure	4pcs + screw kit	
LP-SSPD-2x2	Suspending wire rope for 1x4	3 wire pcs	
LP-SAFETYCLIP	Earthquake clip for panel	1pc	

System Connection Diagram:

A. Wiring of the panel light with 0-10V dimmable driver

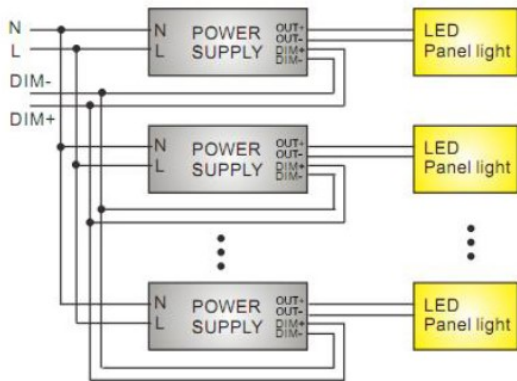

Structure:

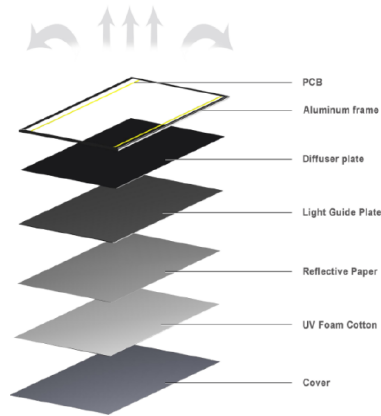

Package:

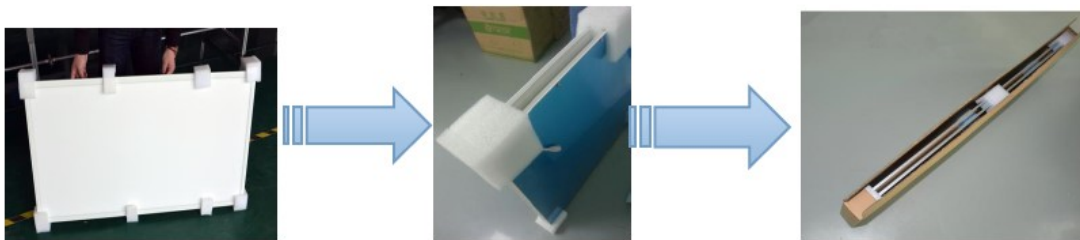

PART NO.	PACKAGE DIMENSION	N.W.	G.W.
2x2 FT 24"X24"X.35"	26" X 4.3" X 26" 2pcs/carton	4.7 kg/pc	9.8kg/ctn
1X4 FT 12"X48"X.35"	50" X 4.3" X 14" 2pcs/carton	4.7 kg/pc	11.1kg/ctn
2X4 FT 24"X48".35"	50" X 4.3" X 26" 2pcs/carton	8.9kg/pc	18.6/ctn

Warning:

- Please use the product within the specified range of voltage.
- Please follow the correct installation steps to install the product, and do not touch when it is working.
- Please turn power off when installing and removing the products to avoid risk of electric shock.
- Please install the panel in the correct sized fixture.
- Do not look directly at LED light source for a long time.



LP-2X2-45W-35K-D
 LP-2X2-45W-40K-D
 LP-2X2-45W-50K-D



LED Panel Light (2x2)

Photometrics:

Spectral Power Distribution & Chromaticity Diagram

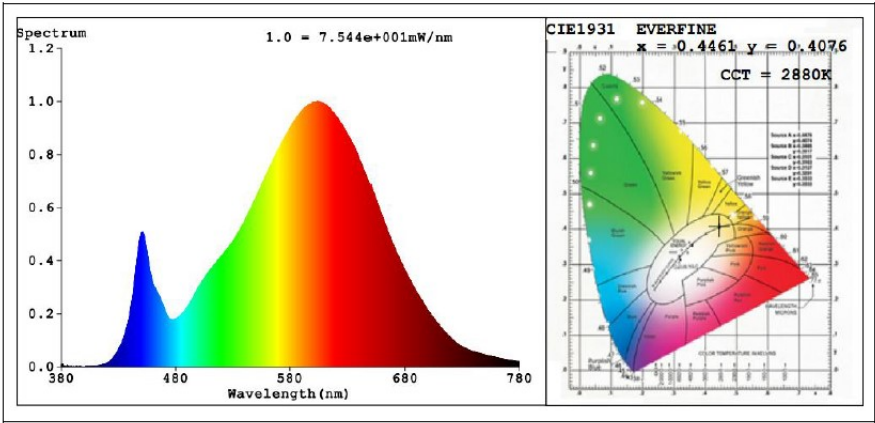

Illuminance Plots

	Center Beam fc	Beam Width	
17.0ft	4.73 fc	50.8 ft	50.4 ft
34.0ft	1.18 fc	101.5 ft	100.8 ft
51.0ft	0.53 fc	152.3 ft	151.2 ft
68.0ft	0.30 fc	203.0 ft	201.5 ft
85.0ft	0.19 fc	253.8 ft	251.9 ft
102.0ft	0.13 fc	304.5 ft	302.3 ft

■ Vert. Spread: 112.4°
■ Horiz. Spread: 112.0°

Photometric Data

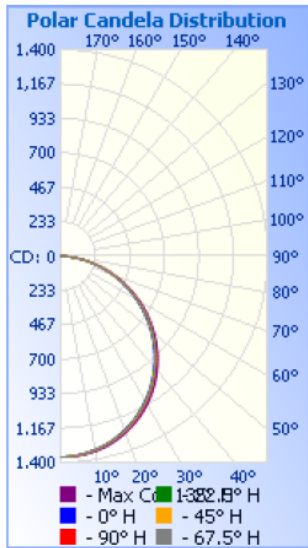

ISOCANDELA DIAGRAM

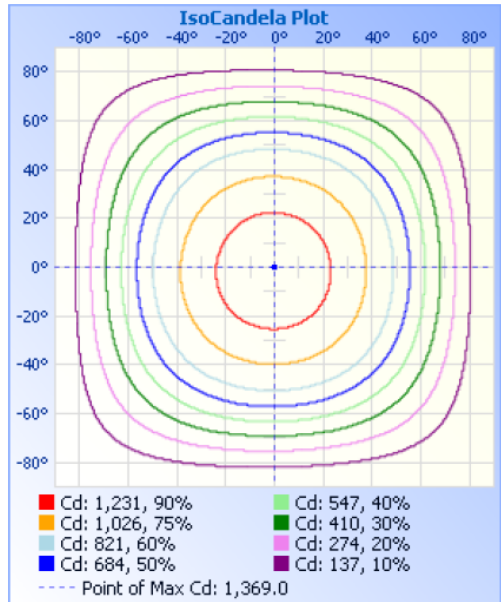

ISOLUX DIAGRAM

