



NAME: LED High Bay Light

P/N : SNC-HB02-100WD1

### Advantage:

- UL cUL DLC certificate
- Mean Well IP65 driver, Input voltage 100-277Vac
- No UV or IR in the beam
- Easy to install and operate
- Energy saving, long lifespan
- Instant start, NO flickering, NO humming
- Green and eco-friendly without mercury
- Output constant current lever can be adjusted through output cable with 1-10V, PWM signal and Resistance.

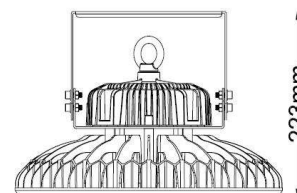
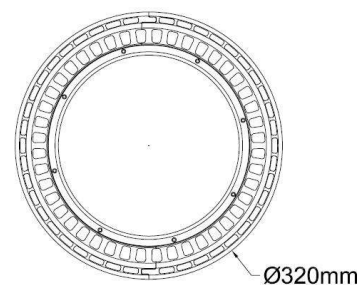
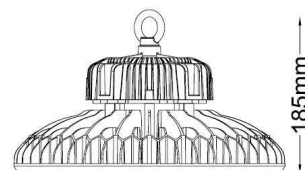
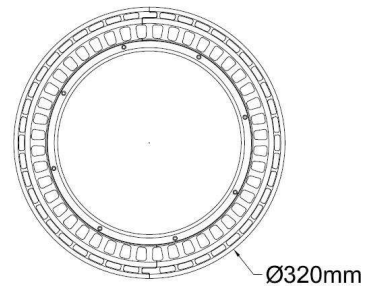

### Application:

- ◆ Warehouse, factory and workshops;
- ◆ Highway toll station and gas station;
- ◆ Exhibition hall;
- ◆ Gymnasium and supermarkets, etc.



# TECHNICAL DATA SHEET

## Product Specifications

Product name	LED High Bay Light
Part No	SNC-HB02-100WD1
Dimension	∅ 320 x 185 mm、∅ 320 x 223 mm

## Technical Characteristic

Color temperature	4000K 5000K 5700K
CRI	>80
Lumen	10500 - 12500LM
Input Power	100W
Viewing Angle	120°
Input Voltage	100-277Vac 50/60Hz
Driver model	HBG-100-60B ( Mean Well Driver )
PFC	>0.9
Waterproof Rating	IP65

## Materials

LED Brand	PHILIPS LUMILEDS
LED Type	LUXEON 3030 2D ( 1.5W )
LED QTY	153 PCS
Housing	Aluminum
Housing color	Black
Cover	Tempered Glass

## Others

Operating Temperature	-20℃ TO 45℃
Operating Humidity	20%-90% RH
Storage Temperature	-30℃ TO 80℃
Storage Humidity	10%-95%
Application	Indoor / Outdoor
Safety Certification	UL、cUL、DLC
Warranty Time	5 Years

## Light Distribution Testing Parameters

DATA OF LAMP		PHOTOMETRIC DATA    Eff: 132.66 lm/W			
MODEL		I <sub>max</sub> (cd)	4373	S/MH (C0/180)	1.31
NOMINAL POWER (W)	100	LOR (%)	100.0	S/MH (C90/270)	1.27
RATED VOLTAGE (V)	120	TOTAL FLUX (lm)	12388	η UP, DN (C0-180)	0.0, 52.1
NOMINAL FLUX (lm)	12387.8	CIE CLASS	DIRECT	η UP, DN (C180-360)	0.0, 47.9
LAMPS INSIDE	1	η up (%)	0.0	CIBSE SHR NOM	1.25
TEST VOLTAGE (V)	120	η down (%)	100.0	CIBSE SHR MAX	1.35

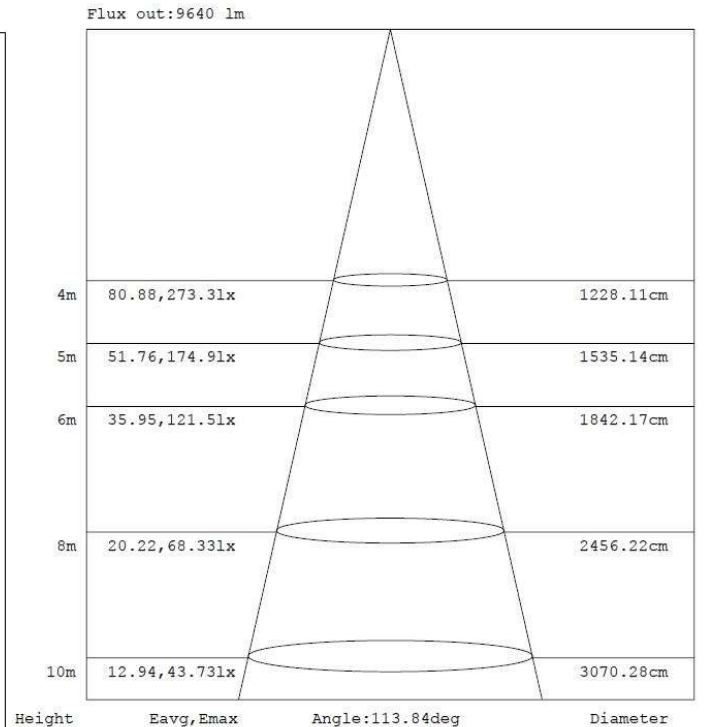
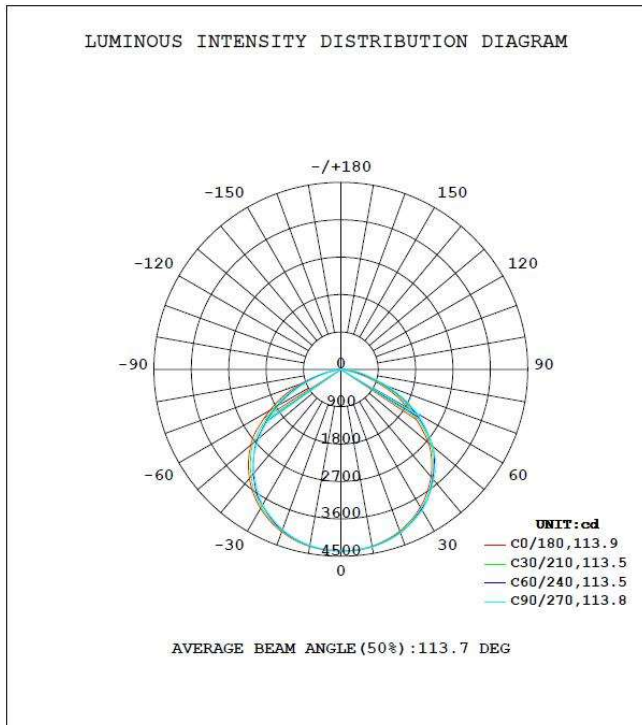

Note: The Curves indicate the illuminated area and the average illumination when the luminaire is at different distance.

## Package

**Lamps Net Weight: 4.9 kg / pc**

	Size	Qty/Carton	Weight/Carton
Outer box	370 x 370 x 200 mm	1	5.9 kg

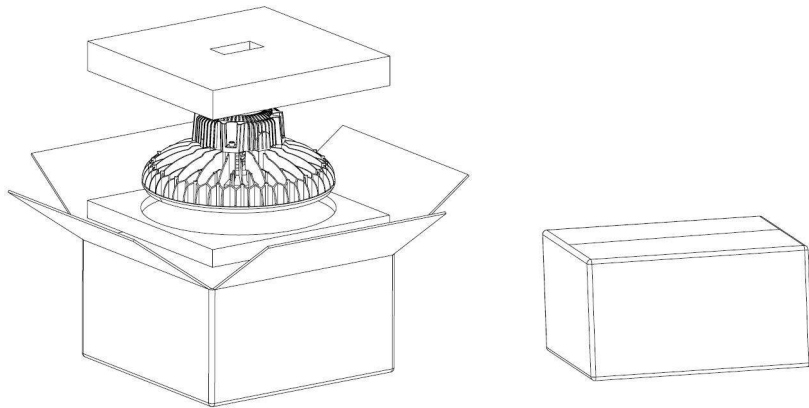

## Notice For User

- ◆ Please turn off power before install or change assembly parts.
- ◆ The input voltage and lamps should be matched, after connecting the power line, Please make sure the wiring section is insulated.
- ◆ No-professionals, must not install and disassemble the lamps.

## Trouble Shootings

Troubles	Check points
Flickering of the light	Turn off the power and turn on again in 3 minutes. If same phenomena occur, then call agencies
Out of working	Please check the connection