



# LED LIGHTING WHOLESALE INC.

## LED MultiPars, LED Par Can, LED Smart Par, LED Pinspot

### IP65 Outdoor LED MultiPars- Quad Color RGBW 4-in-1 LED

New 10W (4in1) *12pcs	Item Number	LED Light Source		Voltage	Fresh Rate	Dimension	M.O.Q	Weight	Unit Price
	LLWI-1210	Quad Color-in-One	12*10W	90-250V AC	>400Hz flicker-free	295*295*285mm	10 Pcs	9.5Kgs	\$540
	Light source: 12pcs * 10W (Quadcolor RGBW 4in1) Edison LEDs Beam: 25°/40° Channels: 8CHs Control mode: DMX512 control, Master/Slave, Automatic run, Stand alone, Sound active Function: Strobe, Color change, Color fade, Dimmer, ID address, Color mixing Led Digital Display Menu DMX in/out: 3-pin XLR Power in/out Daisy Chain No Fan and No Noise; Cooling system: Built-in Convection Heat Transfer Built-in 90-240V Switching Power Supply Black Die-casting Aluminum Housing Shell with 2nd bracket for standing on the floor Optional Parts: Barndoor or Gel color filter Frame Outdoor IP65 Waterproof Grade								

### IP65 Outdoor LED MultiPars- Quad Color RGBW 4-in-1 LED

New 10W (4in1) *18pcs	Item Number	LED Light Source		Voltage	Fresh Rate	Dimension	M.O.Q	Weight	Unit Price
	LLWI-1810	Quad color-in-One	18*10W	90-250V AC	>400Hz flicker-free	295*295*285mm	10 Pcs	11Kgs	\$720
	Light source: 18pcs * 10W (Quad color 4in1) Edison LEDs Beam: 25°/45° Channels: 8CHs Control mode: DMX512 control, Master/Slave, Automatic run, Stand alone, Sound active Function: Strobe, Color change, Color fade, Dimmer, ID address, Color mixing Led Digital Display Menu DMX in/out: 3-pin XLR Power in/out Daisy Chain No Fan and No Noise; Cooling system: Built-in Convection Heat Transfer Built-in 90-240V Switching Power Supply Black Die-casting Aluminum Housing Shell with 2nd bracket for standing on the floor Optional Parts: Barndoor or Gel color filter Frame Outdoor IP65 Waterproof Grade								

### Indoor LED MultiPars- Quad Color RGBW 4-in-1 LED

New 10W (4in1) *12pcs	Item Number	LED Light Source		Voltage	Fresh Rate	Dimension	M.O.Q	Weight	Unit Price
	LLWI-MP1210	Quad color-in-One	12*10W	90-250V AC	>400Hz flicker-free	295*295*285mm	10 Pcs	7Kgs	\$492
	Light source: 12pcs * 10W (Quadcolor RGBW 4in1) Edison LEDs Beam: 25°/40° Channels: 8CHs Control mode: DMX512 control, Master/Slave, Automatic run, Stand alone, Sound active Function: Strobe, Color change, Color fade, Dimmer, ID address, Color mixing Led Digital Display Menu DMX in/out: 3-pin XLR Silent-type Fan Cooling System Built-in 90-240V Switching Power Supply Black Die-casting Aluminum Housing Shell with 2nd bracket for standing on the floor Optional Parts: Barndoor or Gel color filter Frame								

### Indoor LED MultiPars- Quad Color RGBW 4-in-1 LED

New 10W (4in1) *18pcs	Item Number	LED Light Source		Voltage	Fresh Rate	Dimension	M.O.Q	Weight	Unit Price
	LLWI-MP1810	Quad color-in-One	18*10W	90-250V AC	>400Hz flicker-free	295*295*285mm	10 Pcs	7Kgs	\$672
	Light source: 18pcs * 10W (Quadcolor RGBW 4in1) Edison LEDs Beam: 25°/45° Channels: 8CHs Control mode: DMX512 control, Master/Slave, Automatic run, Stand alone, Sound active Function: Strobe, Color change, Color fade, Dimmer, ID address, Color mixing Led Digital Display Menu DMX in/out: 3-pin XLR Silent-type Fan Cooling System Built-in 90-240V Switching Power Supply Black Die-casting Aluminum Housing Shell with 2nd bracket for standing on the floor Optional Parts: Barndoor or Gel color filter Frame								

**Indoor LED MultiPars- Quad Color RGBW 4-in-1 LED**

New 10W (4in1) *18pcs	Item Number	LED Light Source		Voltage	Fresh Rate	Dimension	M.O.Q	Weight	Unit Price
	LLWI-MP2-1810	Quad color-in-One	18*10W	90-250V AC	>400Hz flicker-free	330*290*190mm	10 Pcs	9.5Kgs	\$672
	Light source: 18pcs * 10W (Quadcolor RGBW 4in1) Edison LEDs Beam: 25°/45° Channels: 8CHs Control mode: DMX512 control, Master/Slave, Automatic run, Stand alone, Sound active Function: Strobe, Color change, Color fade, Dimmer, ID address, Color mixing Led Digital Display Menu DMX in/out: 3-pin XLR Silent-type Fan Cooling System Built-in 90-240V Switching Power Supply Black Die-casting Aluminum Housing Shell with 2nd bracket for standing on the floor Optional Parts: Barndoor or Gel color filter Frame								

**IP65 Outdoor LED MultiPars- Tri Color 3-in-1 LED**

New 9W (3in1) *12pcs	Item Number	LED Light Source		Voltage	Fresh Rate	Dimension	M.O.Q	Weight	Unit Price
	LLWI-1809	Tri color-in-One	18*9W	90-250V AC	>400Hz flicker-free	295*295*285mm	10 Pcs	9.5Kgs	\$599
	Light source: 18pcs * 9W (Tri color 3in1) Edison LEDs Beam: 25°/45° Channels: 7CHs Control mode: DMX512 control, Master/Slave, Automatic run, Stand alone, Sound active Function: Strobe, Color change, Color fade, Dimmer, ID address, Color mixing Led Digital Display Menu DMX in/out: 3-pin XLR Power in/out Daisy Chain No Fan and No Noise; Cooling system: Built-in Convection Heat Transfer Built-in 90-240V Switching Power Supply Black Die-casting Aluminum Housing Shell with 2nd bracket for standing on the floor Optional Parts: Barndoor Outdoor IP65 Waterproof Grade								

**Indoor LED MultiPars- 18pcs 9W (3in1)**

New 9W (3in1) *18pcs	Item Number	LED Light Source		Voltage	Fresh Rate	Dimension	M.O.Q	Weight	Unit Price
	LLWI-MP1809	Tri Color-in-One	18*9W	90-250V AC	>400Hz flicker-free	300*280*255mm	10 Pcs	7Kgs	\$576
	Beam: 25°/45° Channels: 9CHs Control mode: DMX512 control, Master/Slave, Automatic run, Stand alone, Sound active Function: Strobe, Color change, Color fade, Dimmer, ID address, Color mixing Led Digital Display Menu DMX in/out: 3-pin XLR Silent-type Fan Cooling System Built-in 90-240V Switching Power Supply Black Die-casting Aluminum Housing Shell with 2nd bracket for standing on the floor Optional Parts: Barndoor								



**Indoor LED Par 64- 18pcs 9W (3in1)**

New 9W (3in1) *18pcs	Item Number	LED Light Source		Voltage	Fresh Rate	Dimension	M.O.Q	Weight	Unit Price
	LLWI-P64-1809	Tri Color-in-One	18*9W	90-250V AC	>400Hz flicker-free	270*220*310mm	10 Pcs	4Kgs	\$374
	Beam: 25°/38°/45° Channels: 8/9CHs Control mode: DMX512 control, Stand alone, Master/Slave, Automatic Run with built-in programs, Sound active Function: Static color, Color fade, Color Changing, Strobe, Light Dimmer, ID address, Color mixing Black or Silver Aluminum Housing Shell Data in/out: locking 3-pin XLR Operation Menu: Led Digital Display Menu or DIP Optional Parts: Color Filter Frame and 2nd Bracket for standing on the floor								

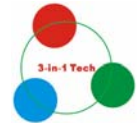

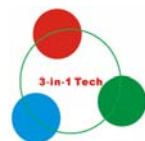

**IP65 Outdoor LED MultiPars- 18pcs 3W (3in1)**

New 3W (3in1) *18pcs	Item Number	LED Light Source		Voltage	Fresh Rate	Dimension	M.O.Q	Weight	Unit Price
	LLWI-1803	Tri color-in-One	18*3W	90-250V AC	>400Hz flicker-free	265*265*330mm	10 Pcs	5Kgs	\$348
	Light Source: 18pcs Tri color 3in1 LEDs Beam: 25°/45° Channels: 3/7CHs Control mode: DMX512 control, Master/Slave, Automatic run, Stand alone, Sound active Function: Strobe, Color change, Color fade, Dimmer, ID address, Color mixing Led Digital Display Menu DMX in/out: 3-pin XLR Power in/out Daisy Chain No Fan and No Noise; Cooling system: Built-in Convection Heat Transfer Built-in 90-240V Switching Power Supply Black Die-casting Aluminum Housing Shell with 2nd bracket for standing on the floor Optional Parts: Barndoor Outdoor IP65 Waterproof Grade								



**IP65 Outdoor LED MultiPars- 36pcs 3W (3in1)**

New 3W (3in1) *36pcs	Item Number	LED Light Source		Voltage	Fresh Rate	Dimension	M.O.Q	Weight	Unit Price
	LLWI-3603	Tri color-in-One	36*3W	90-250V AC	>400Hz flicker-free	310*290*270mm	10 Pcs	10Kgs	\$612
	Light Source: 36pcs 3W Tri Color-in-One LEDs Beam: 25°/40°/45° for Customized Channels: 3/7CHs Control mode: DMX512 control, Master/Slave, Automatic run, Stand alone, Sound active Function: Strobe, Color change, Color fade, Dimmer, ID address, Color mixing Led Digital Display Menu DMX in/out: 3-pin XLR Power in/out Daisy Chain No Fan and No Noise; Cooling system: Built-in Convection Heat Transfer Built-in 90-240V Switching Power Supply Black Die-casting Aluminum Housing Shell with 2nd bracket for standing on the floor Optional Parts: Barndoor Outdoor IP65 Waterproof Grade								

**IP65 Outdoor LED MultiPars- 48pcs 3W (3in1)**

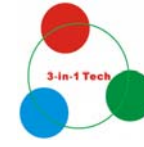
New 3W (3in1) *48pcs	Item Number	LED Light Source		Voltage	Fresh Rate	Dimension	M.O.Q	Weight	Unit Price
	LLWI-4803	Tri color-in-One	48*3W	90-250V AC	>400Hz flicker-free	310*290*270mm	10 Pcs	10Kgs	\$828
	Light Source: 48pcs 3W Tri Color-in-One LEDs Beam: 25°/45° Channels: 9CHs Control mode: DMX512 control, Master/Slave, Automatic run, Stand alone, Sound active Function: Strobe, Color change, Color fade, Dimmer, ID address, Color mixing Led Digital Display Menu DMX in/out: 3-pin XLR Power in/out Daisy Chain No Fan and No Noise; Cooling system: Built-in Convection Heat Transfer Built-in 90-240V Switching Power Supply Black Die-casting Aluminum Housing Shell with 2nd bracket for standing on the floor Optional Parts: Barndoor Outdoor IP65 Waterproof Grade								

**Indoor LED MultiPars- 36pcs 3W (3in1)**

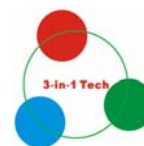
New 3W (3in1) *36pcs	Item Number	LED Light Source		Voltage	Fresh Rate	Dimension	M.O.Q	Weight	Unit Price
	LLWI-MP3603	Tri Color-in-One	36*3W	90-250V AC	>400Hz flicker-free	300*280*255mm	10 Pcs	7Kgs	\$858
	Beam: 25°/45° Channels: 9CHs Control mode: DMX512 control, Master/Slave, Automatic run, Stand alone, Sound active Function: Strobe, Color change, Color fade, Dimmer, ID address, Color mixing Led Digital Display Menu DMX in/out: 3-pin XLR Silent-type Fan Cooling System Built-in 90-240V Switching Power Supply Black Die-casting Aluminum Housing Shell with 2nd bracket for standing on the floor Optional Parts: Barndoor, Gel Color Filter Frame								

**Indoor LED MultiPars- 54pcs 3W (3in1)**

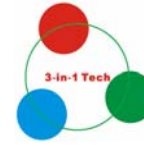
New 3W (3in1) *54pcs	Item Number	LED Light Source		Voltage	Fresh Rate	Dimension	M.O.Q	Weight	Unit Price
	LLWI-MP5403	Tri Color-in-One	54*3W	90-250V AC	>400Hz flicker-free	300*295*285mm	10 Pcs	7Kgs	\$876
	Beam: 25°/45° Channels: 9CHs Control mode: DMX512 control, Master/Slave, Automatic run, Stand alone, Sound active Function: Strobe, Color change, Color fade, Dimmer, ID address, Color mixing Led Digital Display Menu DMX in/out: 3-pin XLR Silent-type Fan Cooling System Built-in 90-240V Switching Power Supply Black Die-casting Aluminum Housing Shell with 2nd bracket for standing on the floor Optional Parts: Barndoor, Gel Color Filter Frame								

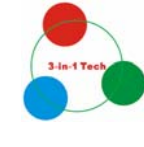

**Indoor LED Par 64- 36pcs 3W (3in1)**

New 3W (3in1) *36pcs	Item Number	LED Light Source		Voltage	Fresh Rate	Dimension	M.O.Q	Weight	Unit Price
	LLWI-P64-3603	Tri Color-in-One	36*3W	90-250V AC	>400Hz flicker-free	270*220*310mm	10 Pcs	4Kgs	\$420
	Beam: 25°/38°/45° Channels: 8/9CHs Control mode: DMX512 control, Stand alone, Master/Slave, Automatic Run with built-in programs, Sound active Function: Static color, Color fade, Color Changing, Strobe, Light Dimmer, ID address, Color mixing Black or Silver Aluminum Housing Shell Data in/out: locking 3-pin XLR Operation Menu: Led Digital Display Menu or DIP Optional Parts: Color Filter Frame and 2nd Bracket for standing on the floor								

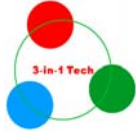
**Indoor LED Par 64- 36pcs 3W (3in1) -Long Can**

	Item Number	LED Light Source		Voltage	Frequency	Dimension	M.O.Q	Weight	Unit Price
	LLWI-P64L-3603	Tri-in-One LED	36*3W	90-250V AC	50-60Hz	270*220*450mm	10 Pcs	4Kgs	\$722
	Beam:15°/25°/38°/45° Channels: 9CHs Control mode: DMX512 control, Stand alone, Master/Slave, Automatic Run with built-in programs, Sound active Function: Static color, Color fade, Color Changing, Strobe, Light Dimmer ,ID address, Color mixing Black or Silver Aluminum Housing Shell Data in/out: locking 3-pin XLR Operation Menu: Led Digital Display Menu or DIP Optional Parts: Color Filter Frame and 2nd Bracket for standing on the floor								

**Indoor LED Par 64- 24pcs 3W (3in1)**

New 3W (3in1) *24pcs	Item Number	LED Light Source		Voltage	Fresh Rate	Dimension	M.O.Q	Weight	Unit Price
	LLWI-P64-2403	Tri Color-in-One	24*3W	90-250V AC	>400Hz flicker-free	270*220*310mm	10 Pcs	4Kgs	\$384
	Beam:25°/45° Channels: 8/9CHs Control mode: DMX512 control, Stand alone, Master/Slave, Automatic Run with built-in programs, Sound active Function: Strobe, Color change, Color fade, Dimmer ,ID address, Color mixing Black or Silver Aluminum Housing Shell Data in/out: locking 3-pin XLR Operation Menu: Led Digital Display Menu or DIP Optional Parts: Color Filter Frame and 2nd Bracket for standing on the floor								

**IP65 Outdoor LED MultiPars- 36pcs 1W LEDs**

R,G,B	Item Number	LED Light Source		Voltage	Fresh Rate	Dimension	M.O.Q	Weight	Unit Price
	LLWI-3601	R G B	36*1W	90-250V AC	>400Hz flicker-free	265*265*330mm	10 Pcs	5Kgs	\$264
	Beam:15°/25°/38°/45° for Customized Channels: 8CHs Control mode: DMX512 control, Master/Slave, Automatic run, Stand alone, Sound active Function: Strobe, Color change, Color fade, Dimmer ,ID address, Color mixing Led Digital Display Menu DMX in/out: 3-pin XLR Power in/out Daisy Chain No Fan and No Noise; Cooling system: Built-in Convection Heat Transfer Built-in 90-240V Switching Power Supply Black Die-casting Aluminum Housing Shell with 2nd bracket for standing on the floor Optional Parts: Barndoor Outdoor IP65 Waterproof Grade								

**IP65 Outdoor LED MultiPars - 36pcs 1W LEDs**

R,G,B	Item Number	LED Light Source		Voltage	Fresh Rate	Dimension	M.O.Q	Weight	Unit Price
	LLWI-3602	R G B	36*1W	90-250V AC	>400Hz flicker-free	282*255*188mm	10 Pcs	5Kgs	\$312
	Hexangular Shape Design, which be combined into different shapes Beam:15°/25°/38°/45° for Customized Channels: 8CHs Control mode: DMX512 control, Master/Slave, Automatic run, Stand alone, Sound active Function: Strobe, Color change, Color fade, Dimmer ,ID address, Color mixing Led Digital Display Menu DMX in/out: 3-pin XLR Power in/out Daisy Chain No Fan and No Noise; Cooling system: Built-in Convection Heat Transfer Built-in 90-240V Switching Power Supply Black Die-casting Aluminum Housing Shell with 2nd bracket for standing on the floor Optional Parts: Barndoor Outdoor IP65 Waterproof Grade								



**IP65 Outdoor LED MultiPars - 48pcs 1W/3W LEDs**

	Item Number	LED Light Source		Voltage	Fresh Rate	Dimension	M.O.Q	Weight	Unit Price
	LLWI-4801-RGBW	R G B W	48*1W	90-250V AC	>400Hz flicker-free	310*290*270mm	10 Pcs	10Kgs	\$465
	LLWI-4803-RGBA	R G B A	48*3W						\$528
Beam: 15°/25°/40°/45° for Customized Channels: 8CHs Control mode: DMX512 control, Master/Slave, Automatic run, Stand alone, Sound active Function: Strobe, Color change, Color fade, Dimmer ,ID address, Color mixing Led Digital Display Menu DMX in/out: 3-pin XLR Power in/out Daisy Chain No Fan and No Noise; Cooling system: Built-in Convection Heat Transfer Built-in 90-240V Switching Power Supply Black Die-casting Aluminum Housing Shell with 2nd bracket for standing on the floor Optional Parts: Barndoor Outdoor IP65 Waterproof Grade									

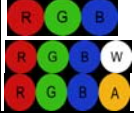
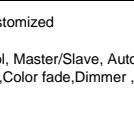
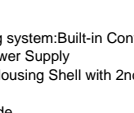
**IP65 Outdoor LED MultiPars - 54pcs 1W/3W LEDs**

	Item Number	LED Light Source	Voltage	Fresh Rate	Dimension	M.O.Q	Weight	Unit Price
	LLWI-5401-RGB		54*1W 54*3W	90-250V AC	>400Hz flicker-free	310*290*270mm	10 Pcs	\$492
	LLWI-5403-RGB							\$576
	LLWI-5401-RGBW							\$588
	LLWI-5401-RGBA							
	LLWI-5403-RGBW							
	LLWI-5403-RGBA							
<p>Beam: 15°/25°/40°/45° for Customized                      Channels: 8CHs                      Control mode: DMX512 control, Master/Slave, Automatic run, Stand alone, Sound active                      Function: Strobe, Color change, Color fade, Dimmer, ID address, Color mixing                      Led Digital Display Menu                      DMX in/out: 3-pin XLR                      Power in/out Daisy Chain                      No Fan and No Noise; Cooling system: Built-in Convection Heat Transfer                      Built-in 90-240V Switching Power Supply                      Black Die-casting Aluminum Housing Shell with 2nd bracket for standing on the floor                      Optional Parts: Barndoor                      Outdoor IP65 Waterproof Grade</p>								



**IP65 Outdoor LED MultiPars - 60pcs 1W/3W LEDs**

NEW-RGBAW	Item Number	LED Light Source	Voltage	Fresh Rate	Dimension	M.O.Q	Weight	Unit Price
	LLWI-6001-RGBAW		60*1W 60*3W	90-250V AC	>400Hz flicker-free	320*300*300mm	10 Pcs	\$564
	LLWI-6003-RGBAW							\$686
<p>Light Source: 60pcs 1W or 3W RGBAW Color LEDs                      Beam: 15°/25°/40°/45° for Customized                      Channels: 10CHs                      Control mode: DMX512 control, Master/Slave, Automatic run, Stand alone, Sound active                      Function: Strobe, Color change, Color fade, Dimmer, ID address, Color mixing                      Led Digital Display Menu                      DMX in/out: 3-pin XLR                      Power in/out Daisy Chain                      No Fan and No Noise; Cooling system: Built-in Convection Heat Transfer                      Built-in 90-240V Switching Power Supply                      Black Die-casting Aluminum Housing Shell with 2nd bracket for standing on the floor                      Optional Parts: Barndoor                      Outdoor IP65 Waterproof Grade</p>								

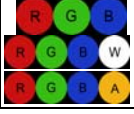

**Indoor LED MultiPars- 36pcs 1W/3W LEDs**

	Item Number	LED Light Source	Voltage	Fresh Rate	Dimension	M.O.Q	Weight	Unit Price
	LLWI-3601		36*1W 36*3W	90-250V AC	>400Hz flicker-free	300*280*255mm	10 Pcs	\$324
	LLWI-3603							\$390
<p>Beam: 15°/25°/40°/45° for Customized                      Channels: 9CHs                      Control mode: DMX512 control, Master/Slave, Automatic run, Stand alone, Sound active                      Function: Strobe, Color change, Color fade, Dimmer, ID address, Color mixing                      Led Digital Display Menu                      DMX in/out: 3-pin XLR                      Silent-type Fan Cooling System                      Built-in 90-240V Switching Power Supply                      Black Die-casting Aluminum Housing Shell with 2nd bracket for standing on the floor                      Optional Parts: Barndoor</p>								

**Indoor LED MultiPars - 5W LEDs**

NEW-5W LED	Item Number	LED Light Source	Voltage	Fresh Rate	Dimension	M.O.Q	Weight	Unit Price
	LLWI-3605		36*5W 36*5W	90-250V AC	>400Hz flicker-free	300*280*255mm	10 Pcs	\$675
<p>Light Source: 36pcs 5W RGB/RGBW/RGBA Color LEDs                      Beam: 15°/25°/40°/45° for Customized                      Channels: 9CHs                      Control mode: DMX512 control, Master/Slave, Automatic run, Stand alone, Sound active                      Function: Strobe, Color change, Color fade, Dimmer, ID address, Color mixing                      Led Digital Display Menu                      DMX in/out: 3-pin XLR                      Silent-type Fan Cooling System                      Built-in 90-240V Switching Power Supply                      Black Die-casting Aluminum Housing Shell with 2nd bracket for standing on the floor                      Optional Parts: Barndoor</p>								

**Indoor LED MultiPars - 48pcs 3W/5W LEDs**

NEW-5W LED	Item Number	LED Light Source	Voltage	Fresh Rate	Dimension	M.O.Q	Weight	Unit Price
	LLWI-4803		48*3W 48*5W	90-250V AC	>400Hz flicker-free	300*280*255mm	10 Pcs	\$960
	LLWI-4805							



Light Source: 48pcs 3W/5W RGBW/RGBA Color LEDs  
 Beam: 15°/25°/40°/45° for Customized  
 Channels: 9CHs  
 Control mode: DMX512 control, Master/Slave, Automatic run, Stand alone, Sound active  
 Function: Strobe, Color change, Color fade, Dimmer, ID address, Color mixing  
 Led Digital Display Menu  
 DMX in/out: 3-pin XLR  
 Silent-type Fan Cooling System  
 Built-in 90-240V Switching Power Supply  
 Black Die-casting Aluminum Housing Shell with 2nd bracket for standing on the floor  
 Optional Parts: Barndoor

### Indoor LED MultiPars - 54pcs 1W/3W LEDs

	Item Number	LED Light Source	Voltage	Fresh Rate	Dimension	M.O.Q	Weight	Unit Price
	LLWI-MP5403	54*3W	90-250V AC	>400Hz flicker-free	300*295*285mm	10 Pcs	7Kgs	\$534
	<p>Light Source: 54pcs 3W RGBW/RGBA LEDs            Beam: 15°/25°/40°/45° for Customized            Channels: 9CHs            Control mode: DMX512 control, Master/Slave, Automatic run, Stand alone, Sound active            Function: Strobe, Color change, Color fade, Dimmer, ID address, Color mixing            Led Digital Display Menu            DMX in/out: 3-pin XLR            Silent-type Fan Cooling System            Built-in 90-240V Switching Power Supply            Black Die-casting Aluminum Housing Shell with 2nd bracket for standing on the floor            Optional Parts: Barndoor</p>							

### Indoor LED MultiPars - 60pcs 1W/3W LEDs

NEW-RGBAW	Item Number	LED Light Source	Voltage	Fresh Rate	Dimension	M.O.Q	Weight	Unit Price
	LLWI-MP6001 LLWI-MP6003	60*1W 60*3W	90-250V AC	>400Hz flicker-free	300*295*285mm	10 Pcs	7Kgs	\$495 \$615
	<p>Light Source: 60pcs 1W or 3W RGBAW LEDs            Beam: 15°/25°/40°/45° for Customized            Channels: 10CHs, RGBAW Color Mxing            Control mode: DMX512 control, Master/Slave, Automatic run, Stand alone, Sound active            Function: Strobe, Color change, Color fade, Dimmer, ID address, Color mixing            Led Digital Display Menu            DMX in/out: 3-pin XLR            Silent-type Fan Cooling System            Built-in 90-240V Switching Power Supply            Black Die-casting Aluminum Housing Shell with 2nd bracket for standing on the floor            Optional Parts: Barndoor</p>							



### Indoor LED MultiPars - 60pcs 5W LEDs

NEW-RGBAW-5W	Item Number	LED Light Source	Voltage	Fresh Rate	Dimension	M.O.Q	Weight	Unit Price
	LLWI-MP6005	60*5W	90-250V AC	>400Hz flicker-free	300*295*285mm	10 Pcs	8Kgs	\$1,230
<p>Light Source: 60pcs 5W RGBAW LEDs            Beam: 15°/25°/40°/45° for Customized            Channels: 10CHs, RGBAW Color Mxing            Control mode: DMX512 control, Master/Slave, Automatic run, Stand alone, Sound active            Function: Strobe, Color change, Color fade, Dimmer, ID address, Color mixing            Led Digital Display Menu            DMX in/out: 3-pin XLR            Silent-type Fan Cooling System            Built-in 90-240V Switching Power Supply            Black Die-casting Aluminum Housing Shell with 2nd bracket for standing on the floor            Optional Parts: Barndoor</p>								



### Indoor LED MultiPars - 84pcs 1W/3W LEDs

New-RGBAW	Item Number	LED Light Source	Voltage	Fresh Rate	Dimension	M.O.Q	Weight	Unit Price
	LLWI-MP8403	84*3W	90-250V AC	>400Hz flicker-free	300*295*285mm	10 Pcs	8Kgs	\$960
<p>Light Source: 84pcs 3W RGBW/RGBA/RGBAW LEDs            RGBWA Color Mixing            Beam: 15°/25°/40°/45° for Customized            Channels: 10CHs, RGBW/RGBA/RGBAW Color Mxing            Control mode: DMX512 control, Master/Slave, Automatic run, Stand alone, Sound active            Function: Strobe, Color change, Color fade, Dimmer, ID address, Color mixing            Led Digital Display Menu            DMX in/out: 3-pin XLR            Silent-type Fan Cooling System            Built-in 90-240V Switching Power Supply            Black Die-casting Aluminum Housing Shell with 2nd bracket for standing on the floor            Optional Parts: Barndoor</p>								

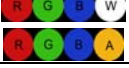

**Indoor LED Par 64 - 36pcs 1W/3W LEDs**

	Item Number	LED Light Source	Voltage	Frequency	Dimension	M.O.Q	Weight	Unit Price
	LLWI-P64-3601		90-250V AC	50-60Hz	270*220*310mm	10 Pcs	4Kgs	\$252
	LLWI-P64-3603							36*1W 36*3W
<p>Beam:15°/25°/38°/45° Channels: 5/6/8/9CHs Control mode: DMX512 control, Stand alone, Master/Slave, Automatic Run with built-in programs, Sound active Function: Static color, Color fade, Color Changing, Strobe, Light Dimmer ,ID address, Color mixing Black or Silver Aluminum Housing Shell Data in/out: locking 3-pin XLR Operation Menu: Led Digital Display Menu or DIP Optional Parts: Color Filter Frame and 2nd Bracket for standing on the floor</p>								



**Indoor LED Par 64 - 36pcs 3W LEDs-Long Can**

	Item Number	LED Light Source	Voltage	Frequency	Dimension	M.O.Q	Weight	Unit Price
	LLWI-P64-3603		90-250V AC	50-60Hz	270*220*310mm	10 Pcs	4Kgs	\$336
<p>Beam:15°/25°/38°/45° Channels: 9CHs Control mode: DMX512 control, Stand alone, Master/Slave, Automatic Run with built-in programs, Sound active Function: Static color, Color fade, Color Changing, Strobe, Light Dimmer ,ID address, Color mixing Black or Silver Aluminum Housing Shell Data in/out: locking 3-pin XLR Operation Menu: Led Digital Display Menu or DIP Optional Parts: Color Filter Frame and 2nd Bracket for standing on the floor</p>								

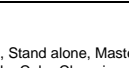
**Indoor LED Par 64 - 36pcs 1W/3W LEDs-Long Can**

	Item Number	LED Light Source	Voltage	Frequency	Dimension	M.O.Q	Weight	Unit Price
	LLWI-P64L-3601		90-250V AC	50-60Hz	270*220*450mm	10 Pcs	4Kgs	\$264
	LLWI-P64L-3603							36*1W 36*3W
<p>Beam:15°/25°/38°/45° Channels: 8CHs Control mode: DMX512 control, Stand alone, Master/Slave, Automatic Run with built-in programs, Sound active Function: Static color, Color fade, Color Changing, Strobe, Light Dimmer ,ID address, Color mixing Black or Silver Aluminum Housing Shell Data in/out: locking 3-pin XLR Operation Menu: Led Digital Display Menu or DIP Optional Parts: Color Filter Frame and 2nd Bracket for standing on the floor</p>								

**Indoor LED Par 64 - 151/177/181\*10mm LEDs**

	Item Number	LED Light Source	Voltage	Frequency	Dimension	M.O.Q	Weight	Unit Price
	LLWI-P64-181		90-250V AC	50-60Hz	270*220*310mm	20 Pcs	4Kgs	\$114
<p>Beam:15°/25°/38°/45° Channels: 5/6/8/9CHs Control mode: DMX512 control, Stand alone, Master/Slave, Automatic Run with built-in programs, Sound active Function: Static color, Color fade, Color Changing, Strobe, Light Dimmer ,ID address, Color mixing Black or Silver Aluminum Housing Shell Data in/out: locking 3-pin XLR Operation Menu: Led Digital Display Menu or DIP Optional Parts: Color Filter Frame and 2nd Bracket for standing on the floor</p>								

**Indoor LED UV Color Par 64 - 151\*10mm LEDs**

	Item Number	LED Light Source	Voltage	Frequency	Dimension	M.O.Q	Weight	Unit Price
	LLWI-UVP64	UV LED 151*10mm	90-250V AC	50-60Hz	240*240*350mm	20 Pcs	4Kgs	\$150
<p>Light source: 151 10mm UV LEDs LED Angel: 25° Channel: 2 Channels Control model: DMX 512, Auto Run, Stand Alone, Master/Slave;Function: Strobe, Dimmer Black or Silver Aluminum Housing Shell Data in/out: locking 3-pin XLR Operation Menu: Led Digital Display Menu or DIP Optional Parts: Color Filter Frame and 2nd Bracket for standing on the floor</p>								

**Indoor LED Par 64 - 151/177/181\*10mm LEDs-Long Can**

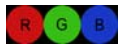
	Item Number	LED Light Source	Voltage	Frequency	Dimension	M.O.Q	Weight	Unit Price
	LLWIP64L-181		90-250V AC	50-60Hz	270*220*450mm	20 Pcs	4Kgs	\$120
<p>Beam: 15°/25°/38° Channels: 5/6/8/9CHs Control mode: DMX512 control, Stand alone, Master/Slave, Automatic Run with built-in programs, Sound active Function: Static color, Color fade, Color Changing, Strobe, Light Dimmer ,ID address, Color mixing Black or Silver Aluminum Housing Shell Data in/out: locking 3-pin XLR Operation Menu: Led Digital Display Menu or DIP Optional Parts: Color Filter Frame and 2nd Bracket for standing on the floor</p>								

### Indoor Flat LED Par -68pcs Super Bright LEDs

NEW	Item Number	LED Light Source		Voltage	Frequency	Dimension	M.O.Q	Weight	Unit Price
	LLWI-903	Tri-in-One LED	9*3W	90-250V AC	50-60Hz	240*215*130mm	20 Pcs	4Kgs	\$178
Beam:25° or 45° Channels: 6CHs Control mode: DMX512 control, Stand alone, Master/Slave, Automatic Run with built-in programs, Sound active Function: Static color, Color fade, Color Changing, Strobe, Light Dimmer ,ID address, Color mixing Black Housing Shell Data in/out: locking 3-pin XLR Operation Menu: LED display Power in and Power out for Daisy Chain									

### Indoor Slim Flat LED Par-144pcs 10mm LEDs

New	Item Number	LED Light Source		Voltage	Frequency	Dimension	M.O.Q	Weight	Unit Price
	LLWI-902	R,G,B R,G,B,W R,G,B,A,W	144*10mm	90-250V AC	50-60Hz	240*215*130mm	20 Pcs	3Kgs	\$129
Beam:25° Channels: 3/6/7CHs Control mode: DMX512 control, Stand alone, Master/Slave, Automatic Run with built-in programs, Sound active Function: Static color, Color fade, Color Changing, Flash ,Color mixing Black Housing Shell Data in/out: locking 3-pin XLR Operation Menu: LED display Power in and Power out for Daisy Chain									

### Indoor LED Par 56 - 151/177/181\*10mm LEDs

	Item Number	LED Light Source		Voltage	Frequency	Dimension	M.O.Q	Weight	Unit Price
	LLWI-P56-181	R G B	181*10mm	90-250V AC	50-60Hz	220*195*250mm	20 Pcs	3Kgs	\$108
Beam: 15°/25°/38° Channels: 4CHs Control mode: DMX512 control, Stand alone, Master/Slave, Automatic Run with built-in programs Function: Static color, Color fade, Color Changing, Strobe, Light Dimmer ,ID address, Color mixing Black or Silver Aluminum Housing Shell Data in/out: locking 3-pin XLR Operation Menu: Led Digital Display Menu or DIP Optional Parts: Color Filter Frame and 2nd Bracket for standing on the floor									

### Indoor LED Smart Par -18pcs 1W/3W LEDs

	Item Number	LED Light Source		Voltage	Frequency	Dimension	M.O.Q	Weight	Unit Price
	LLWI-SMARTpar-1801 LLWI-SMARTpar-1803	RGB RGBW RGBW Tri Color	18*1W 18*3W	90-250V AC	50-60Hz	220*190*180mm	20 Pcs	2.5Kgs	\$195 \$234 \$246 \$345
Beam Angle: 15°/25°/38° Channels: 6CHs Control mode: DMX512 control, Stand alone, Master/Slave, Automatic Run with built-in programs Function: Static color, Color fade, Color Changing, Strobe 1-32/s, Light Dimmer 0-100% ,ID address, Color mixing Black Fire-proof ABS Housing Shell Data in/out: locking 3-pin XLR Operation Menu: LED Display Menu/LCD Display Menu Optional Parts: Black Barndoor and 2nd bracket for standing on the floor									



### Indoor LED Par 36

	Item Number	LED Light Source		Voltage	Frequency	Dimension	M.O.Q	Weight	Unit Price
	LLWI-P36-901 LLWI-P36-1202	R G B	9*1W 12*1W	90-250V AC	50-60Hz	190*120*120mm	20 Pcs	1.5Kgs	\$84 \$120
Beam: 15°/25°/38° Channels: 4CHs Control mode: DMX512 control, Stand alone, Master/Slave, Automatic Run with built-in programs, Sound active Function: Static color, Color fade, Color Changing, Strobe, Light Dimmer ,ID address, Color mixing Black or Silver Aluminum Housing Shell Data in/out: locking 3-pin XLR Operation Menu: Led Digital Display Menu or DIP									

### LED Strobe Light-20W LEDs

Hot Selling-3in1	Item Number	LED Light Source		Voltage	Frequency	Dimension	M.O.Q	Weight	Unit Price
	LLWI-STROBE-W20	White Color LED	20W	90-250V AC	50-60Hz	180*90*220mm	50 Pcs	1.5Kgs	\$81
Light Source: 20W White LED Light weight high tech plastic case Strobe speed control knob on rear panel In/Out 1/4" mono plugs on real to link with other LED Strobe light Compatible with S-1 strobe remote controller Power Draw: 20W Max Dimensions:180*90*220mm GW: 1.5kgs									

### Indoor LED PinSpot-3W LEDs

Hot Selling	Item Number	LED Light Source		Voltage	Frequency	Dimension	M.O.Q	Weight	Unit Price
	LLWI-PINSPOT-3	White Color RED Color Green Color Blue Color Amber Color	3W	90-250V AC	50-60Hz	65*65*200mm	30 Pcs	1.5Kgs	\$57
	Beam Angle: 6 degree Lens Bright 3W White LED Compact high tech plastic case design Long life LED: 50000 hours lamp life Very Low heat output and power consumption Includes hanging bracket Switchable power supply: 90-240V, 50/60Hz								

### Indoor LED PinSpot-3W LEDs

Hot Selling	Item Number	LED Light Source		Voltage	Frequency	Dimension	M.O.Q	Weight	Unit Price
	LLWI-PINESPOT-W3B	White Color	3W	90-250V AC	50-60Hz	150*150*130mm	50 Pcs	1.5Kgs	\$54
	Beam Angle: 6 degree Lens Bright 3W White LED Compact high tech plastic case design Long life LED: 50000 hours lamp life Very Low heat output and power consumption Includes hanging bracket Switchable power supply: 90-240V, 50/60Hz								

### DMX LED PinSpot-9W LEDs

Hot Selling-3in1	Item Number	LED Light Source		Voltage	Frequency	Dimension	M.O.Q	Weight	Unit Price
	LLWI-PINESPOT-TRI9	Tri Color-in-One	9W	90-250V AC	50-60Hz	150*150*130mm	50 Pcs	1.5Kgs	\$72
	Bright 9W Tri color in One LED Pinspot 4 DMX Channels 2 operation modes: DMX&Auto Master/Slave 6-degree beam angle lens Compact high-tech plastic case design Long-life LED: 50,000 hour lamp life Very low heat output and power consumption (Power Draw: 10W) Switchable power supply: 90 - 240V, 50Hz/60Hz								

### DMX LED PinSpot-15W LEDs

Hot Selling-3in1	Item Number	LED Light Source		Voltage	Frequency	Dimension	M.O.Q	Weight	Unit Price
	LLWI-PINESPOT TRI15	Tri Color-in-One	15W	90-250V AC	50-60Hz	140*120*160mm	50 Pcs	1.5Kgs	\$81
	Bright 15W Tri color in One LED Pinspot 4 DMX Channels 2 operation modes: DMX&Auto Master/Slave 6-degree beam angle lens Linkable via XLR mounting socket connection Compact high-tech plastic case design Very low heat output and power consumption Switchable power supply: 90 - 240V, 50Hz/60Hz								